

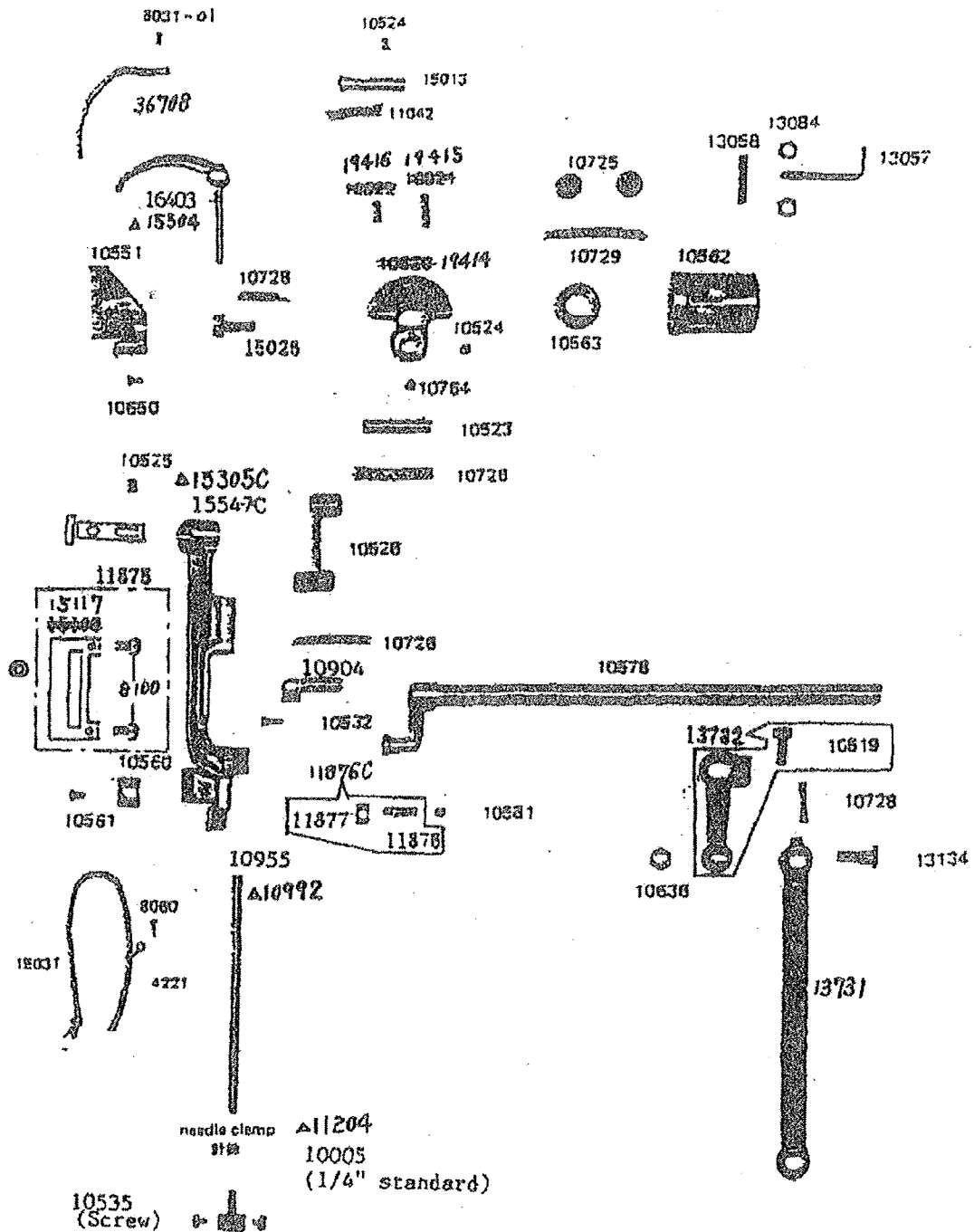

MODEL
MODEL 387RB

PARTS BOOK

THREAD TAKE-UP LEVER, NEEDLE BAR MECHANISM FOR MODEL 387RB & 384RB



Parts marked with O are for 387RB
Parts marked with ^ are for 384RB

T 10712

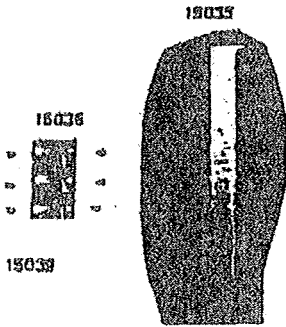
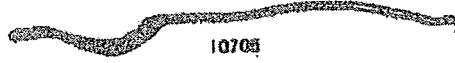
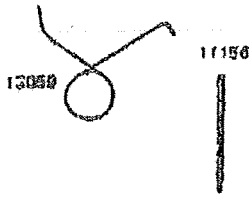

15038

15039

15037

for $\frac{1}{4}$ " (6.4mm)

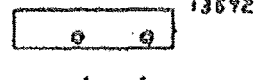
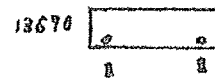
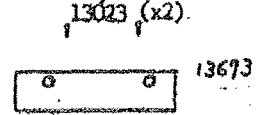
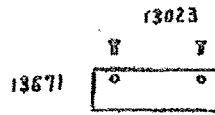

THREAD GUIDE. THREAD TENSION, FEED DRIVING ROCK SHAFT FOR MODEL 387RB & 384RB

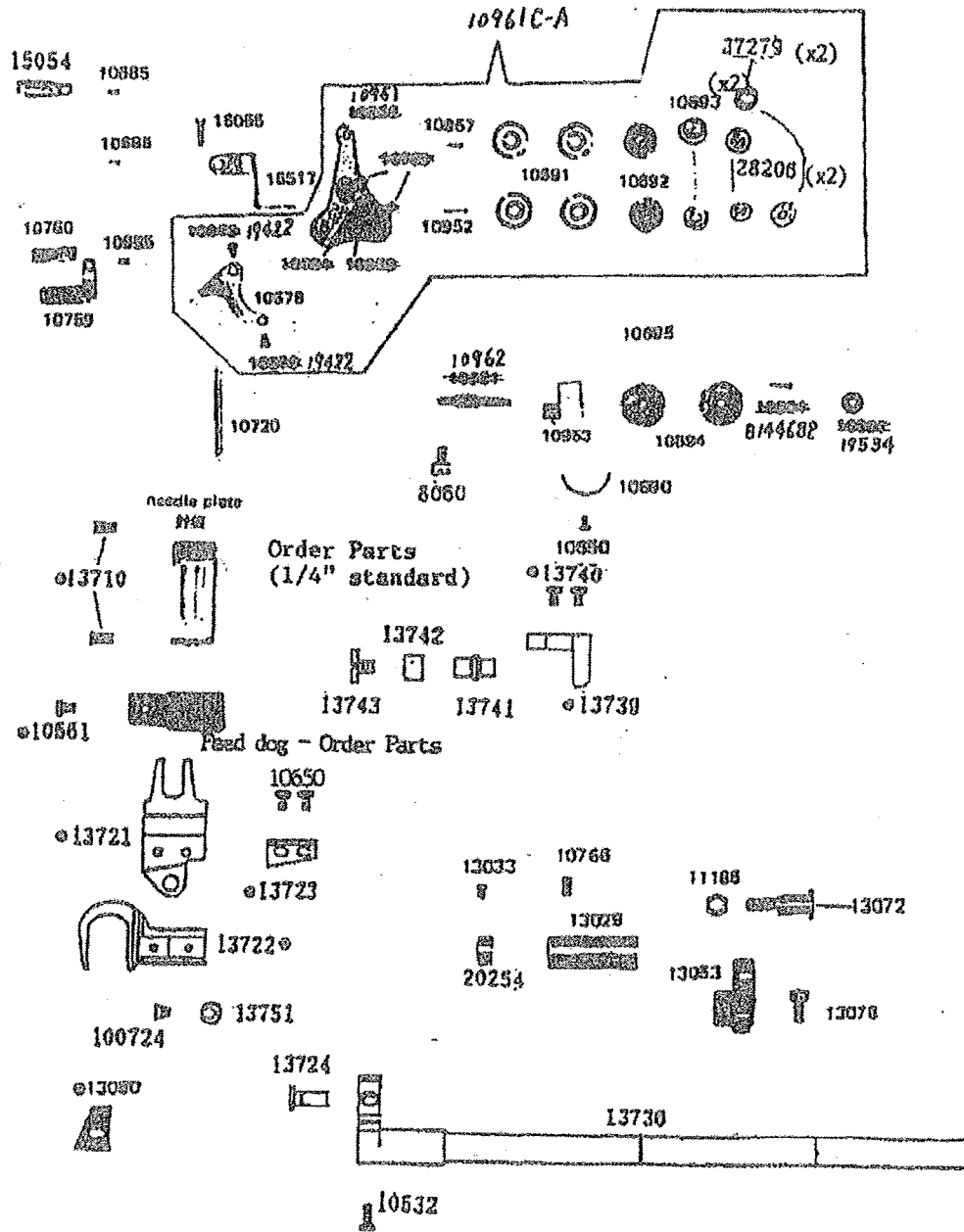

PRESSER BAR, LIFTING ROCK SHAFT, INSIDE PRESSER FOOT

FOR MODEL 384RB ONLY

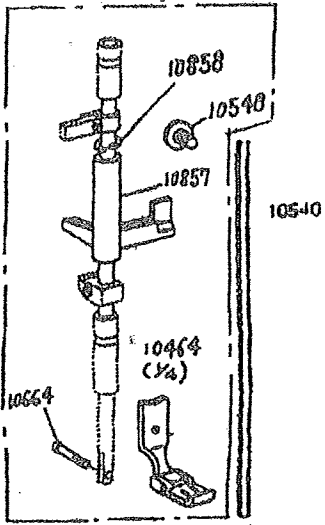

FOR MODEL 387RB ONLY

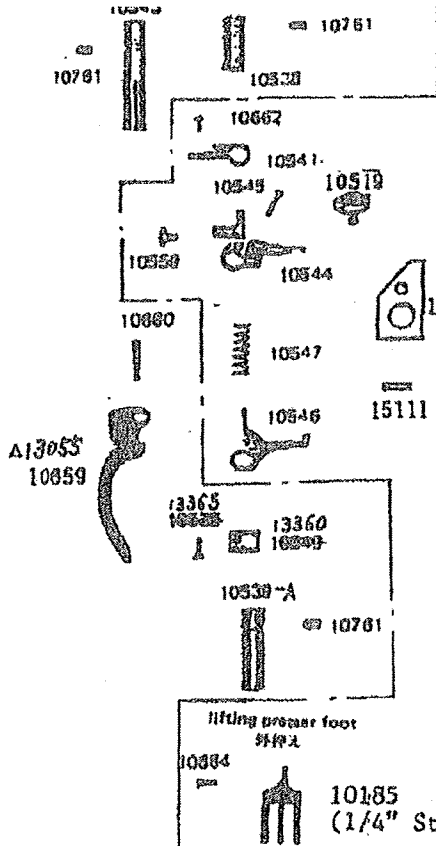
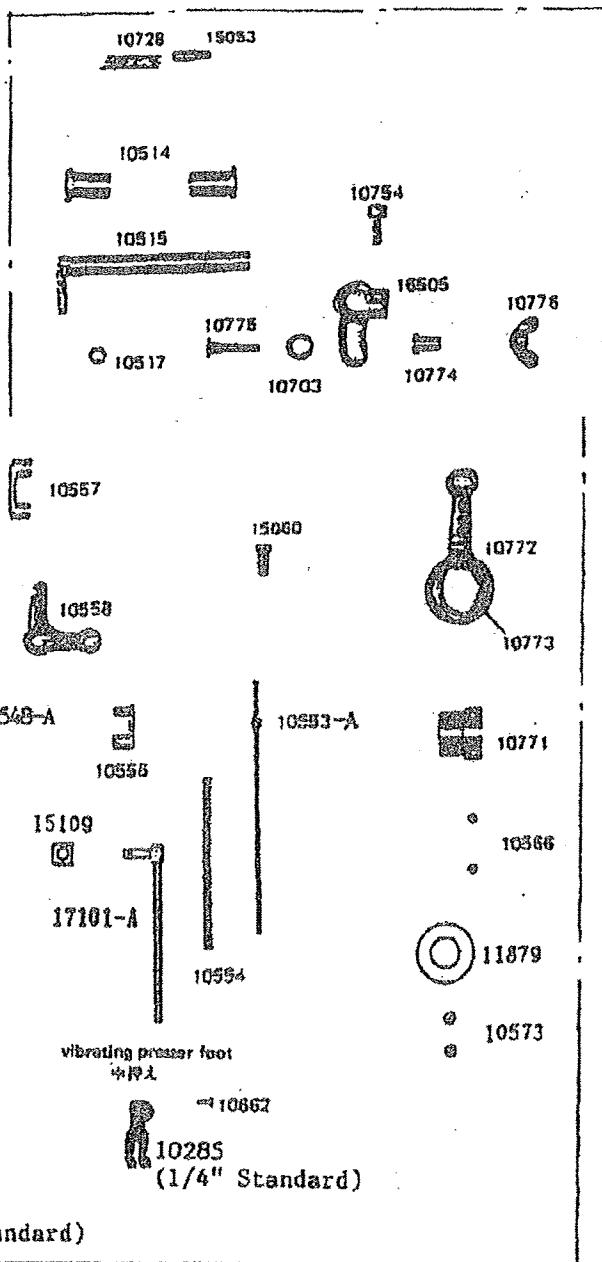

ALL PARTS OUTSIDE THE LINES ARE FOR BOTH MODELS

LOWER SHAFT AND HOOK

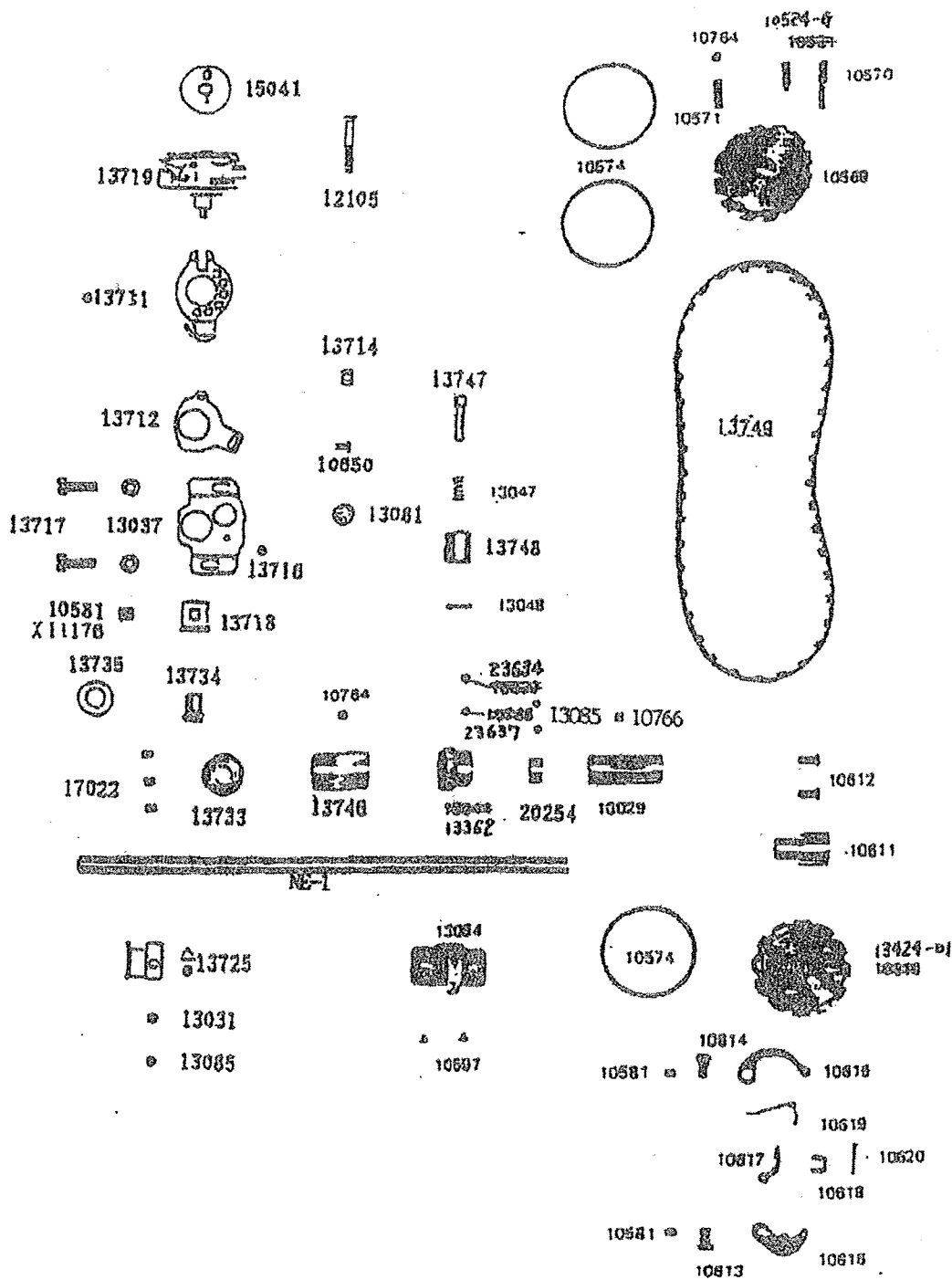

NE-1

REVERSE STITCHING MECHANISM

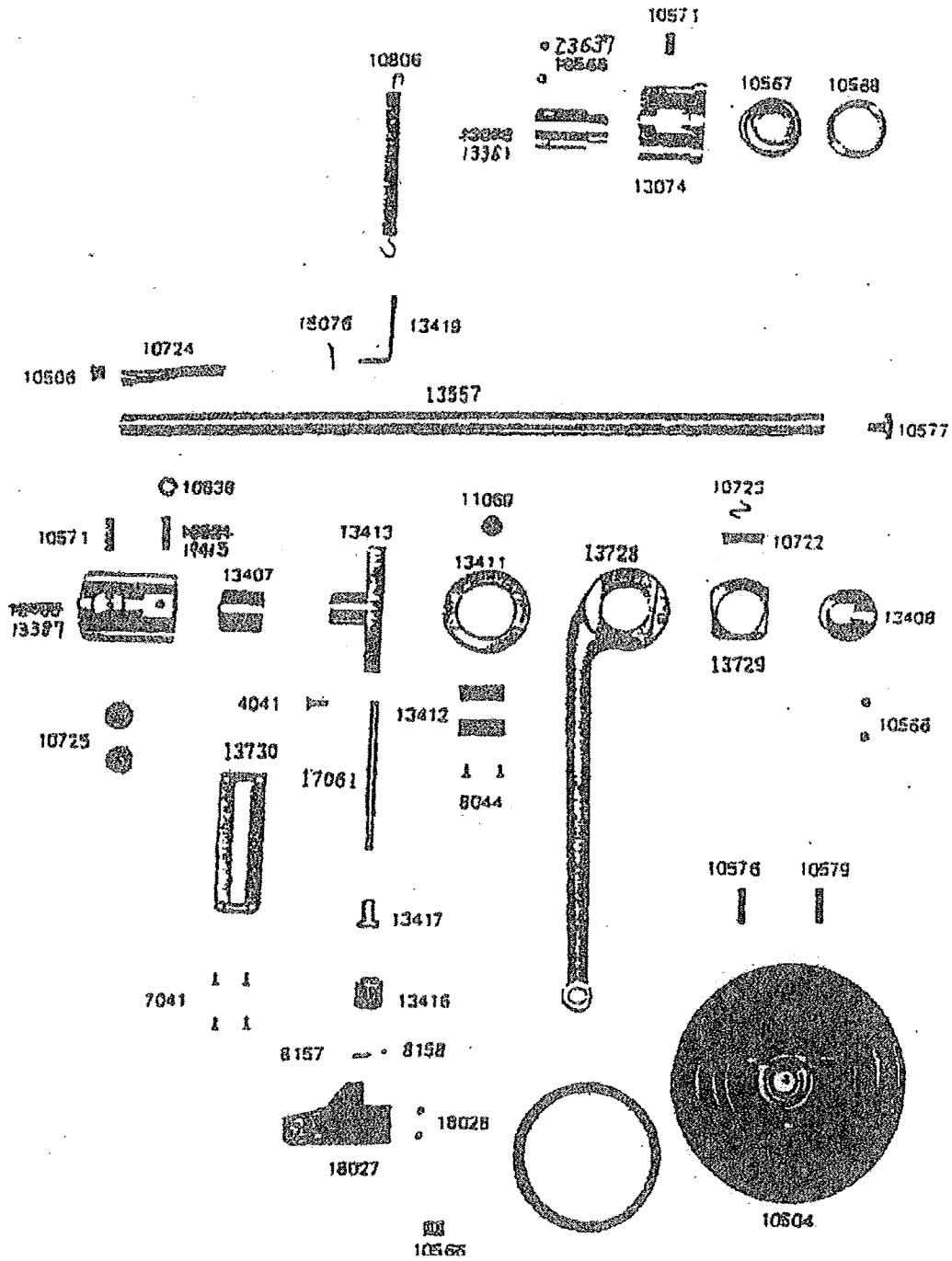

13493-A USE WITH GUARD
 13493-B WITHOUT GUARD

UPPER PLATE & LUBRICATION SYSTEM

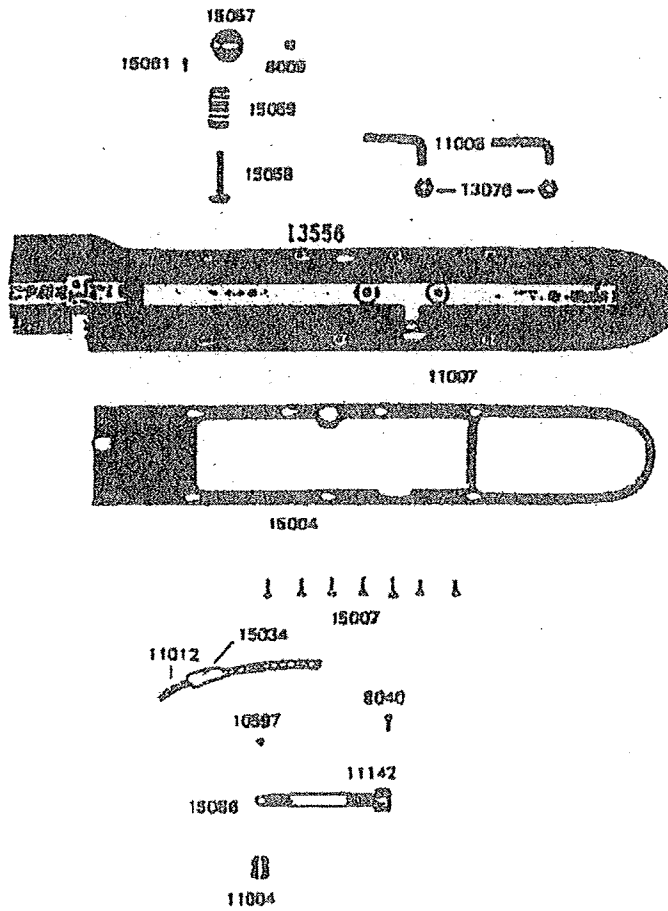

BELT COVER

13425

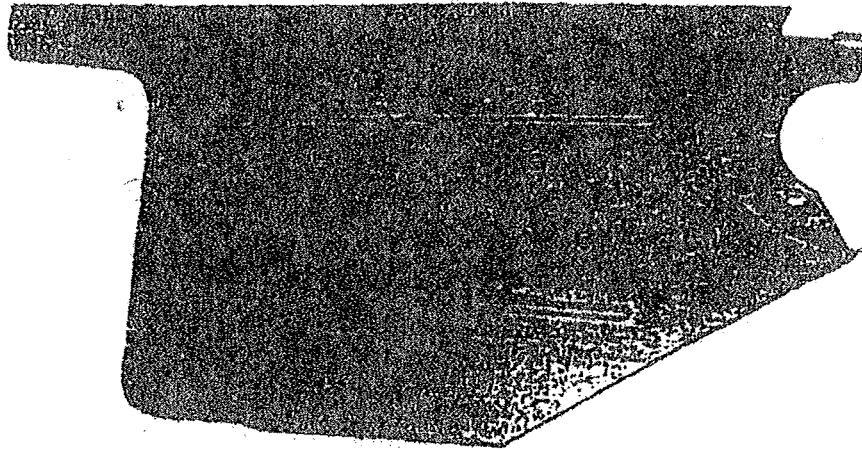

13427



50103



50099



14024



8339



11142



10581

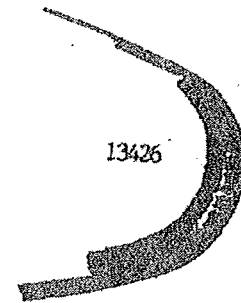

13426

ACCESSORIES

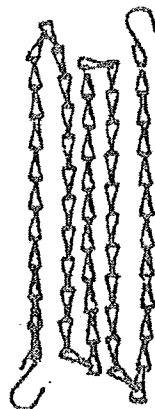
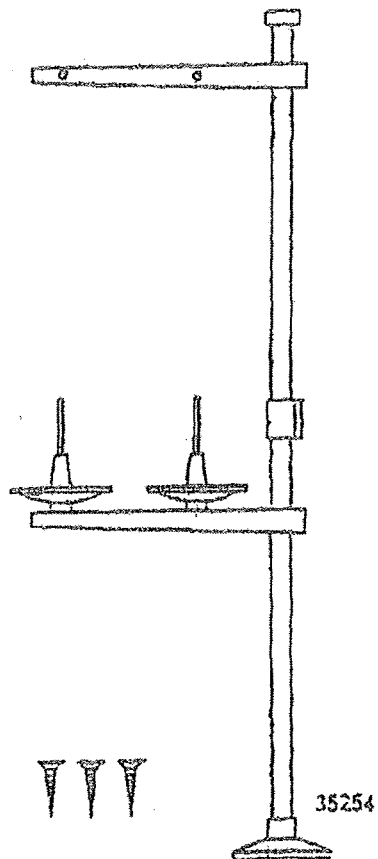
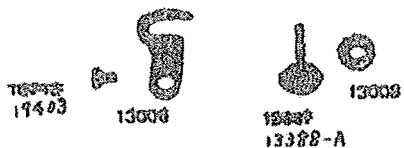
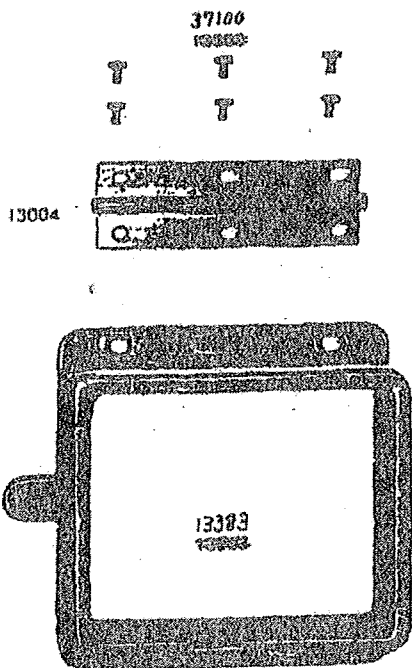

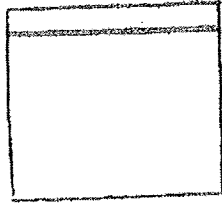

8132-B

15041

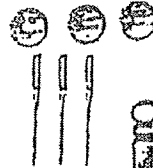

8332

10748

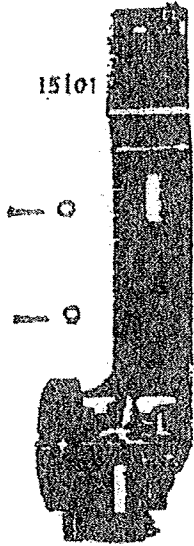

15101

11969



50285



8118



8120



8121



8125

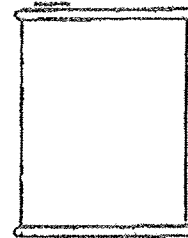

11193

13094

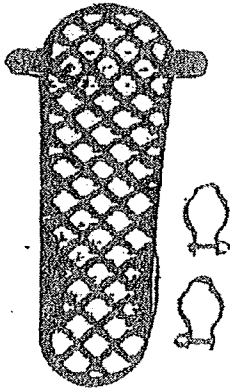



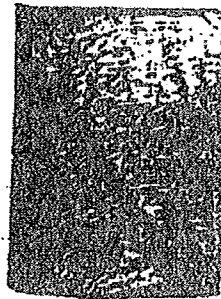

8124

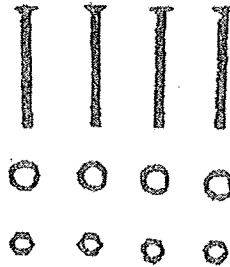





13096



PARTS FOR MODEL 387RB

GAUGE		ゲージ部品 (PARTS)				
		針板 needle plate	送り歯 feed dog	針挟 needle clamp	中押え writing presser foot	外押え Hilly presser foot
針幅 (GAUGE)						
in	mm					
1/8"	3.2	13690	13651	10002	10282	10182
1/4"	6.4	13652	13653	10005	10285	10185
3/8"	9.5	13654	13655	10007	10287	10187
1/2"	12.7	13656	13657	10009	10289	10189

PARTS FOR 384RB

GAUGE		ゲージ部品 (PARTS)			
		針板 needle plate	送り歯 feed dog	針挟 needle clamp	押え presser foot
針幅 (GAUGE)					
in	mm				
1/4"	6.4	13652	13653	11204	10485

Consolidated Sewing Machine Corp.

Website: www.consew.com

MAIN office

131 W. 25th Street
New York, NY 10001
Tel: 212-741-7788
Fax: 212-741-7787
e-mail: consew@att.net

Miami, FL

4013 N.W. 79th Avenue
Miami, FL 33166
Tel: 305-471-0200
Fax: 305-471-0243
e-mail: miamisales@consew.com

Los Angeles, CA

2320 South Hill Street
Los Angeles, CA 90007
Tel: 213-745-8844
Fax: 213-745-8855
e-mail: lasales@consew.com