

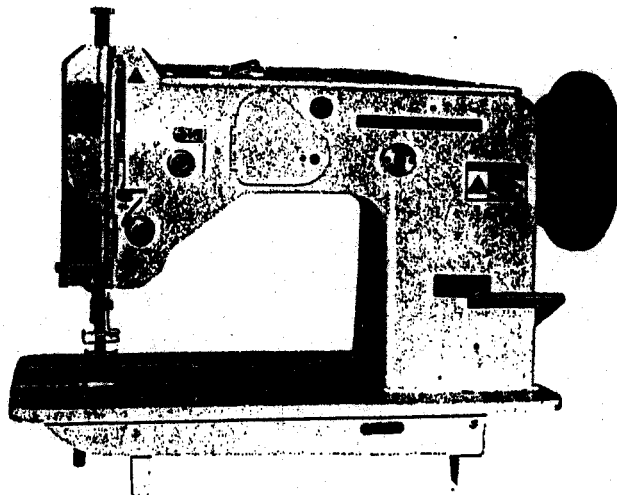









**PARTS LIST FOR
SKZ-6 & SKZ-6B**

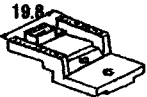

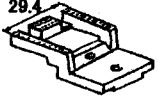
SEIKO SEWING MACHINE CO., LTD.
TOKYO • JAPAN

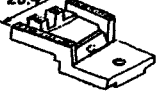
SKZ-6,6B

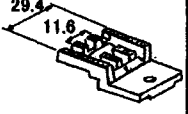
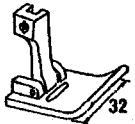
ゲージ部品一覧表/GAUGE PARTS LIST

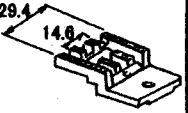
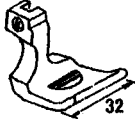
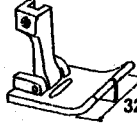
		針板 THROTE PLATE	送り歯 FEED DOG	自由押え HINGED PRESSER FOOT																					
3列 3 ROW	巾狭 NARROW	 1878-A	 1881-A	 1867-AC																					
	巾広 WIDE	 1878	 1881	 1865C																					
	4枚歯 4 TEETH	 1858	 1862																						
4列 4 ROW	6枚歯 巾狭 6 TEETH NARROW	 1877	 1882	 1893-AC	固定押え SOLID PRESSER FOOT	固定押え(溝付) PIPING FOOT	自由押え(ガイド付) HINGED FOOT W/ GUIDE	割リガイド(別売り品) GUIDE PLATE (OPTION)																	
	6枚歯 巾広 6 TEETH WIDE	 1876	 1880		 1894	<table border="1"> <thead> <tr> <th>A (mm)</th> <th>NO.</th> </tr> </thead> <tbody> <tr><td>11.0</td><td>1885</td></tr> <tr><td>8.2</td><td>1886</td></tr> <tr><td>6.6</td><td>1887</td></tr> <tr><td>5.2</td><td>1888</td></tr> <tr><td>6.2</td><td>1889</td></tr> <tr><td>9.4</td><td>1890</td></tr> <tr><td>4.8</td><td>1891</td></tr> <tr><td>7.2</td><td>1892</td></tr> </tbody> </table>	A (mm)	NO.	11.0	1885	8.2	1886	6.6	1887	5.2	1888	6.2	1889	9.4	1890	4.8	1891	7.2	1892	 1893-BC
	A (mm)	NO.																							
11.0	1885																								
8.2	1886																								
6.6	1887																								
5.2	1888																								
6.2	1889																								
9.4	1890																								
4.8	1891																								
7.2	1892																								

PBA-006(0702)

FACE PLATE. ARM TOP COVER. IRON LETTER LEVER

15007
Y Y Y Y Y

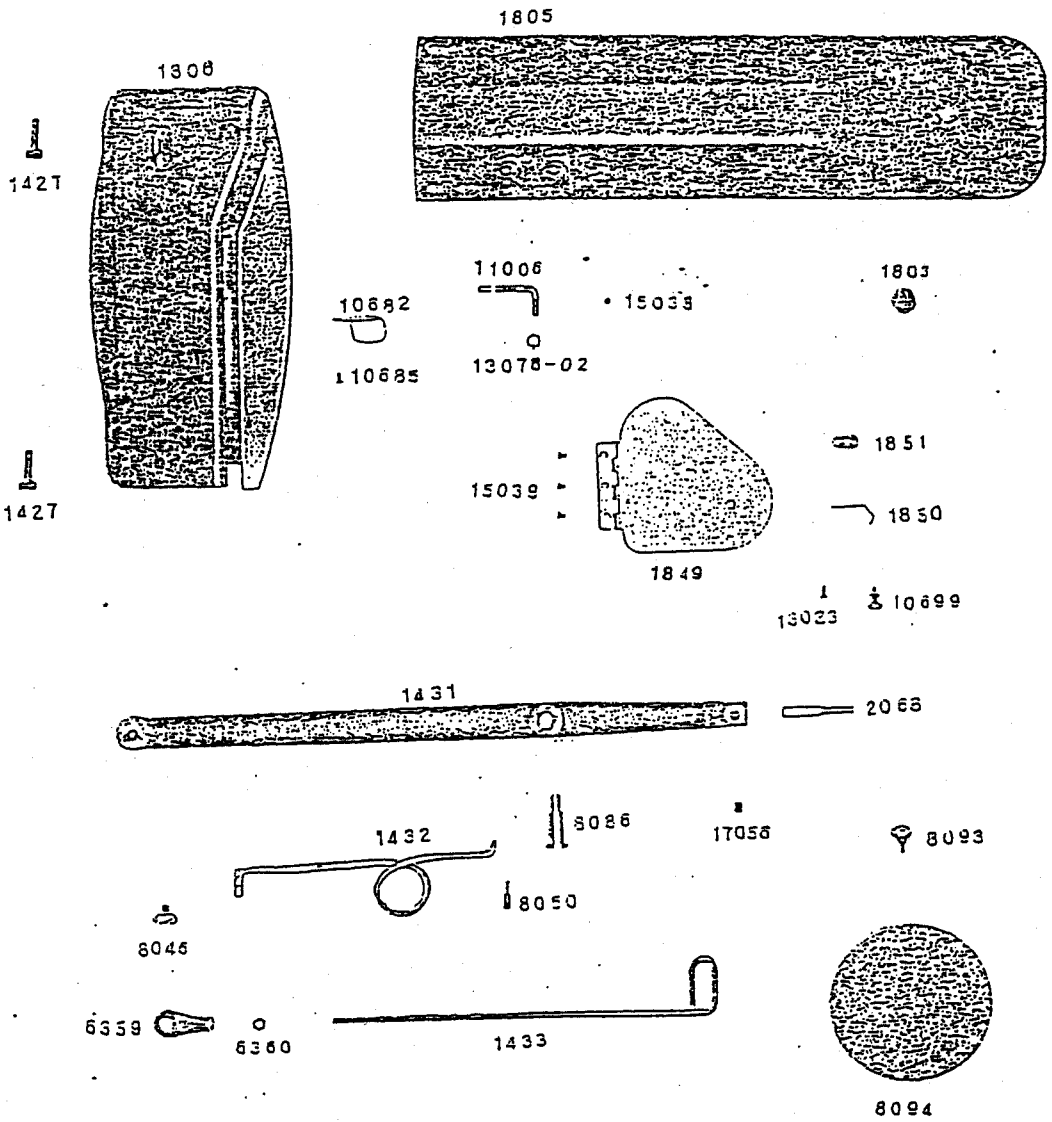

Y Y Y Y Y

10794

PRESSER BAR, NEEDLE BAR, TAKE UP LEVER, TENSION GROUP, THREAD GUIDE

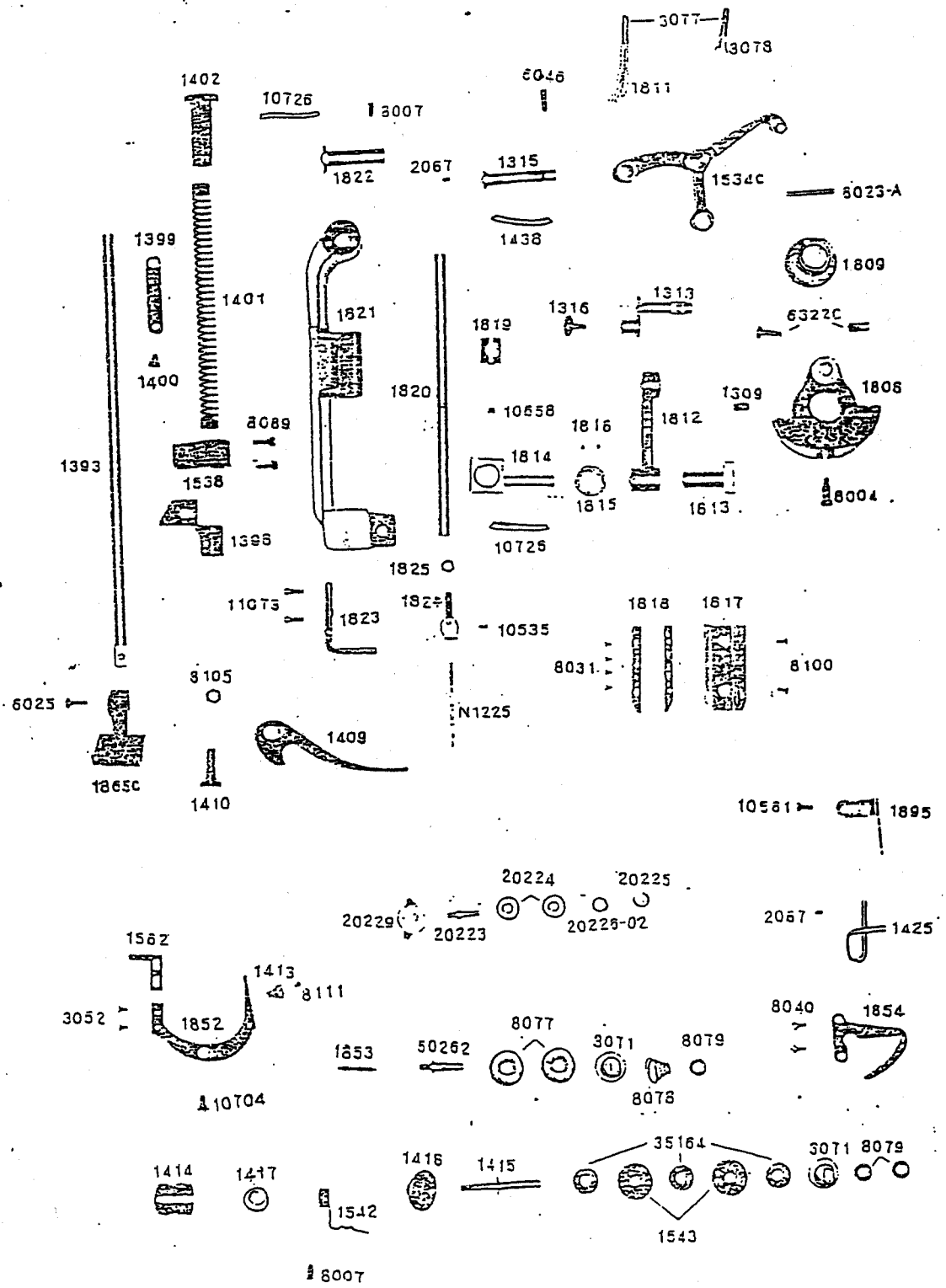

FEED MECHANISM, LOWER SEAT, EOCK

Y Y-1860-Y Y

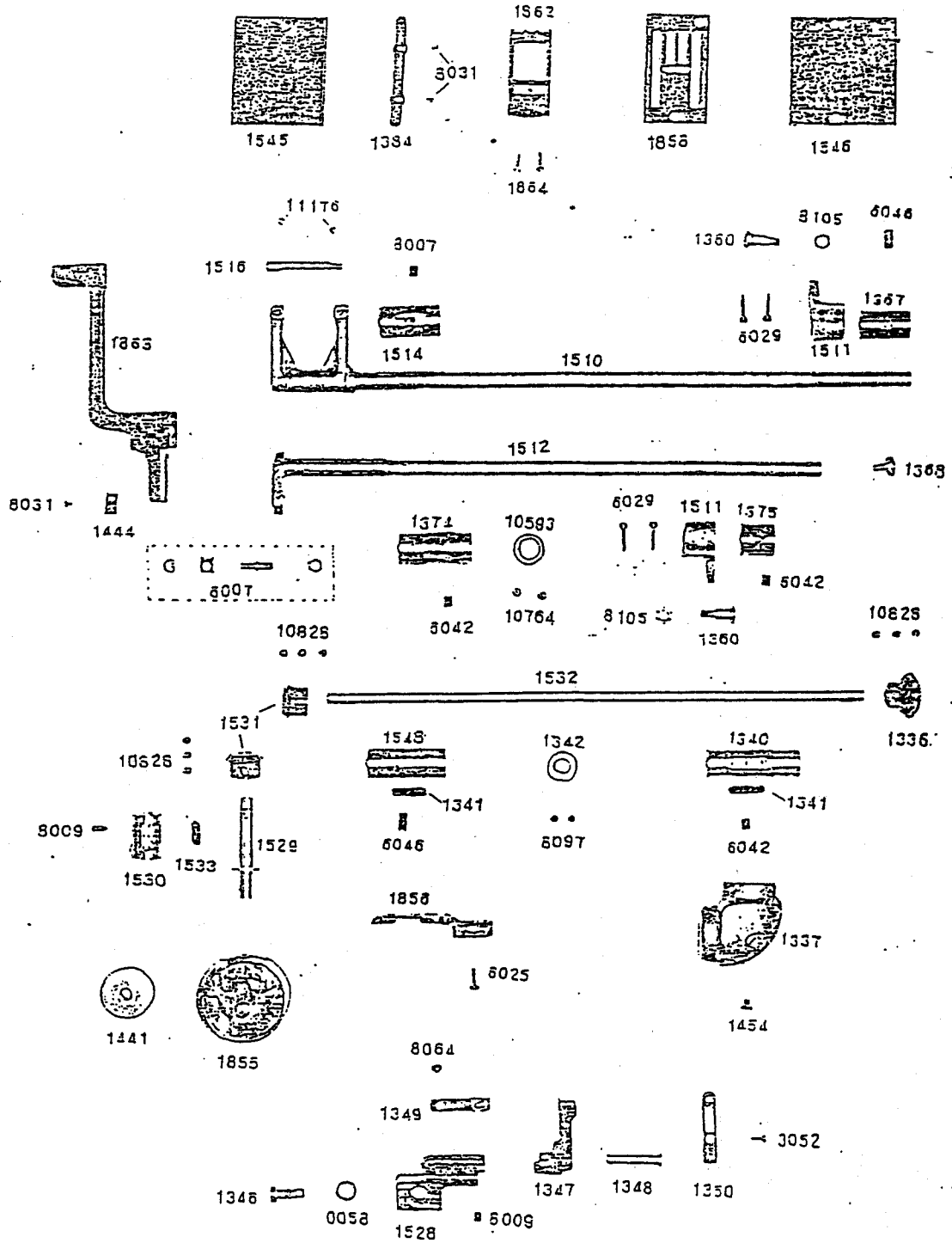

REVERSE FEEDING MACHANISM

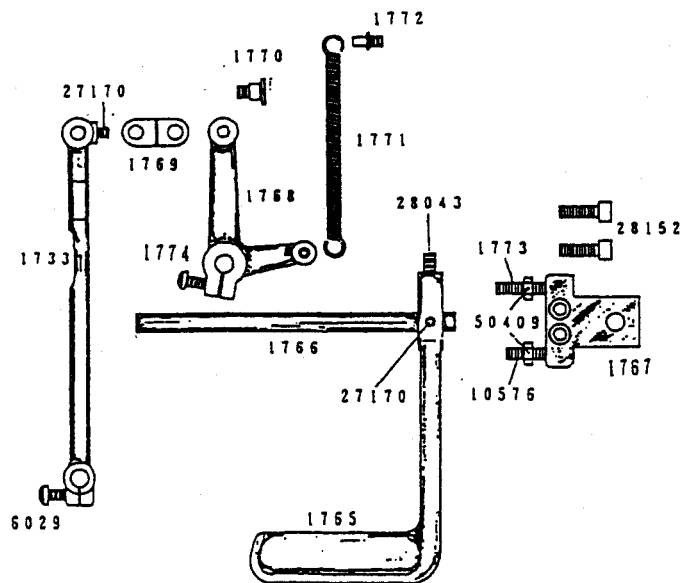
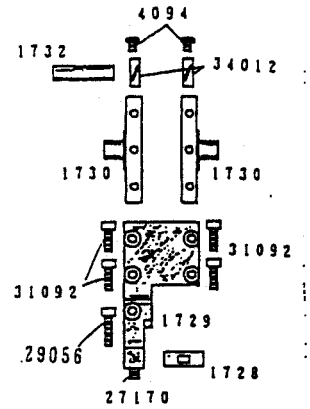
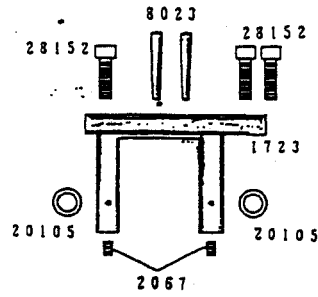

ZIGZAG MECHANISM. ARM SHAFT

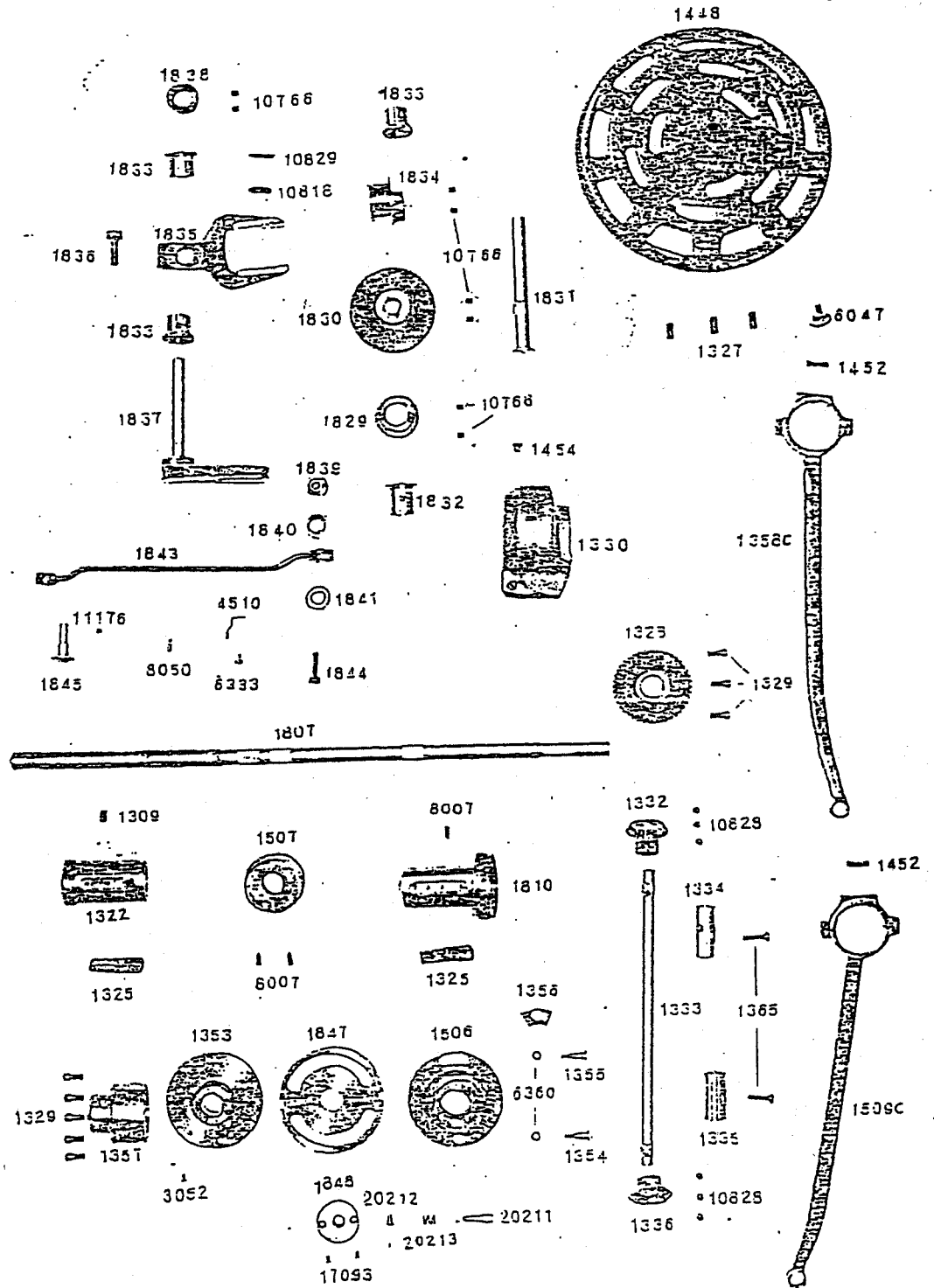

COTTON STAND. EYES LIFTER. OIL PAN

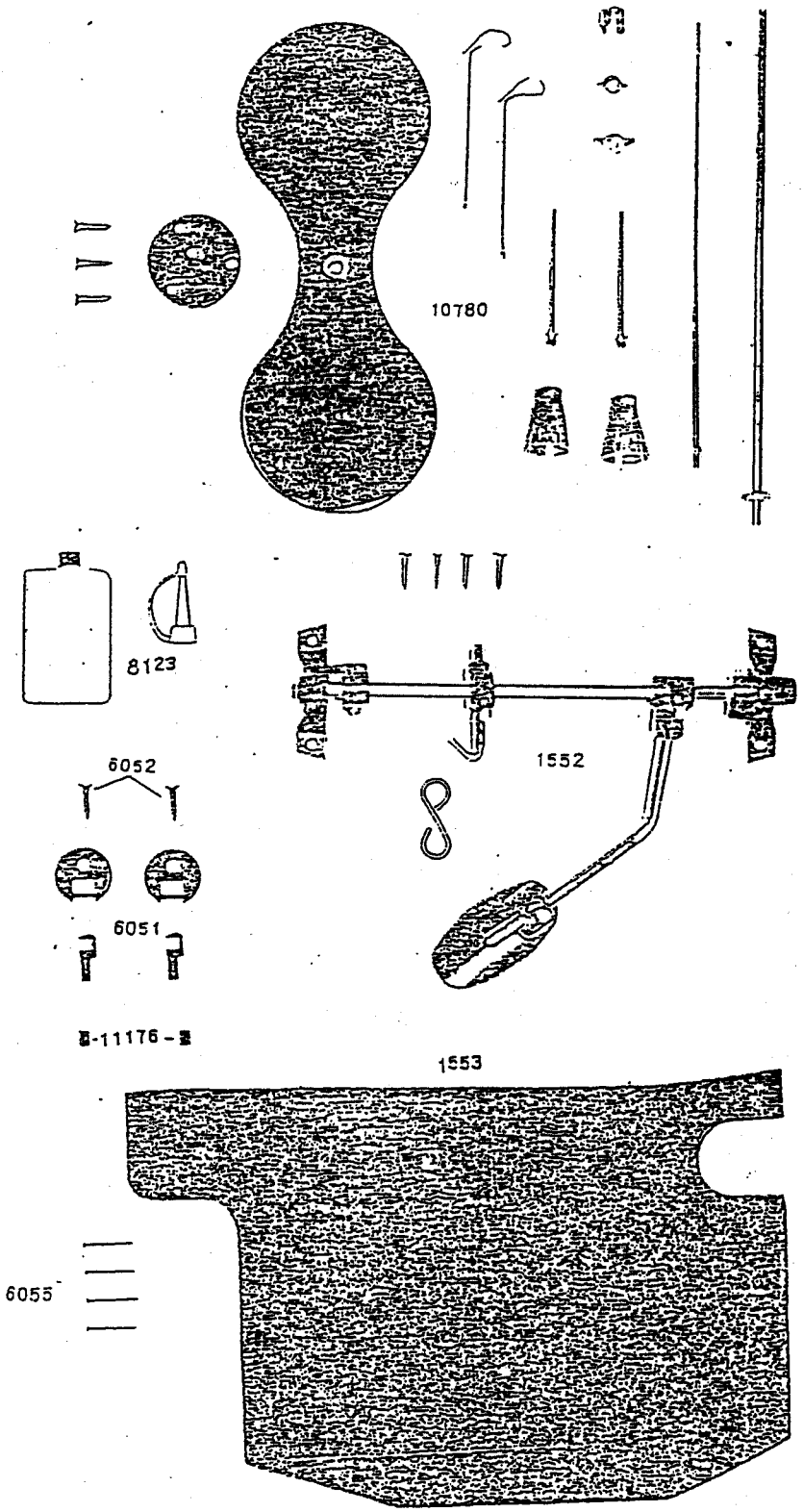

BELT GUARD - Optional Equipment

(set No. is 1873C)

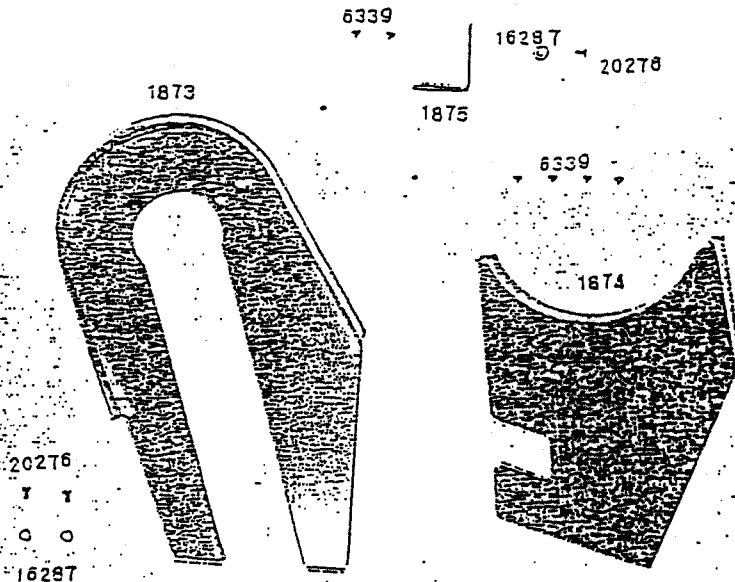

SCREW PARTS

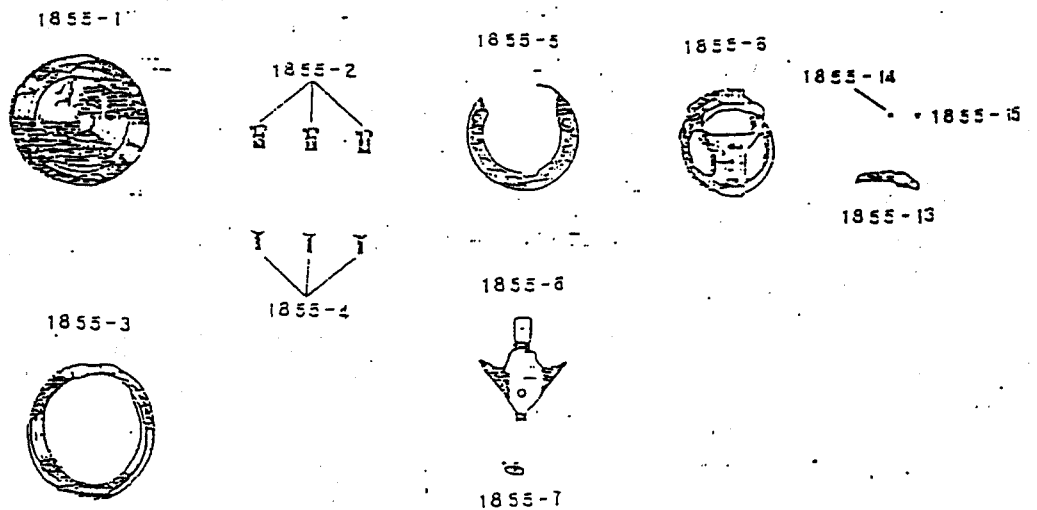

ACCESSORIES

8132

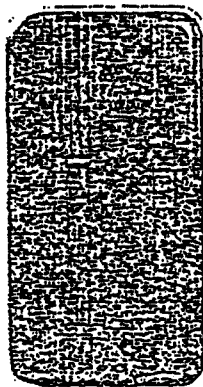

8124

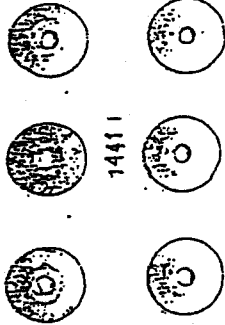

1441

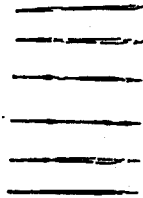

N1225

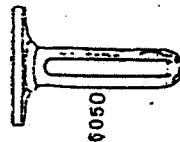

6050



7047

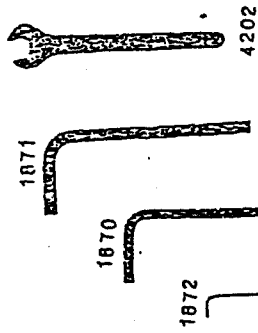

1871

1870

1872

4202

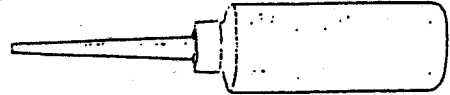

8125



8120

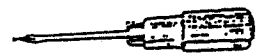

8121



8119

SKZ-6-3

SPECIAL PARTS FOR SKZ-6-3 THREE
POINTS ZIGZAG STITCHING

