

# Pfaff

Mauser Spezial 51

Mauser Spezial 53

Mauser Spezial 55

Subclass

---

**PFAFF**<sup>®</sup>

**MAUSER SPEZIAL**

**51**  
**53**  
**55**

**Unterklassen-Ausstattung**  
Subclass parts  
Composition des sous-classes  
Composición de las subclases

## Equipement des sous-classes

## Dotación de las subclases

Maschinenklasse Machine class Clase de máquina	Nadelabstand in mm Needle gauge in mm Ecartement des aiguilles en mm Distancia entre agujas en mm	Nadelhalter Needle holder Pince-aiguille Portaaguja	Stoffschieber Feed dog Griffe Transportador inferior	Stoffschieber, hinten Feed dog, rear Griffe hintere Transportador inferior detrás	Stoffschieber, vorn Feed dog, front Griffe avant Transportador inferior delante	Sichplatte Needle plate Plaque à aiguille Pieza de aguja	Stoffdrückerfuß Presser foot Pied presseur Pie prensatelas
<b>51</b>							
-23300-01 -990/01	6,0	96-702 044-91		96-712 086-05	96-712 085-05	96-711 570-05	96-711 569-91
<b>53</b>							
-23100-01 (-990/01)	3,5	96-702 034-91	96-710 550-05			96-711 423-05	96-711 415-91
-23100-01 (-990/01) (-990/02)	4,5	96-702 036-91	96-710 550-05			96-711 426-05	96-721 221-93 x 4,5 96-711 424-91 [2]
-23100-01 (-990/01)	6,0	96-702 044-91	96-712 108-05			96-711 434-05	96-711 431-91
-23100-02 (-990/01) (-990/02)	4,5	96-702 036-91	96-711 454-05			96-711 453-05	96-711 446-91
-23300-01 (-990/01)	3,5	96-702 034-91		96-710 397-05	96-710 398-05	96-711 423-05	96-721 221-93 x 3,5 96-711 415-91 [2]
-23300-01 (-990/01)	4,5	96-702 036-91		96-710 397-05	96-710 398-05	96-711 426-05	96-721 221-93 x 4,5 96-711 424-91 [2]
-23300-01	6,0	96-702 044-91		96-712 090-05	96-712 099-05	96-711 434-05	96-711 431-91
-23300-011 -990/01 (-990/02)	4,5	96-702 036-91		96-705 586-05	96-710 398-05	96-705 596-05	96-707 458-91
-23300-02 (-990/01)	3,5	96-702 034-91		96-705 248-05	96-710 398-05	96-711 452-05	96-711 445-91
-23300-02 (-990/01)	4,5	96-702 036-91		96-705 248-05	96-710 398-05	96-711 453-05	96-711 446-91
-23500-020 -990/01	4,5	96-702 036-91	96-711 454-05			96-711 453-05	96-703 668-91
-24301-01	4,5	96-702 036-91		96-705 586-05	96-710 398-05	96-705 596-05	96-705 600-91
-34300-01 (-990/01)	5,4	96-702 030-91		96-705 586-05	96-711 174-05	96-705 593-05	96-706 095-91
-35303-01	3,5 x 4,0	96-702 073-91		96-702 598-05	96-702 725-05	96-711 152-05	96-707 105-91
-35303-02	3,5 x 4,0	96-702 073-91		96-702 598-05	96-702 725-05	96-711 152-05	96-707 105-91
<b>55</b>							
-23300-41 -990/01	4,5	96-702 036-91		96-702 635-05	96-702 616-05	96-705 504-05	96-705 572-91
-23370-41 (-990/01)	3,5	96-702 034-91		96-702 635-05	96-702 616-05	96-705 834-05	96-707 852-91 96-705 574-91 [2]
-23370-41 -990/01	4,5	96-702 036-91		96-702 635-05	96-702 616-05	96-706 010-05	96-707 853-91 96-705 572-91 [2]
-23500-01	3,5	96-702 034-91	96-711 503-05 96-711 502-05 [2]			96-711 442-05	96-711 437-91

\* Zusätzlich Kordelführung Nr. 96-780 080-90 erforderlich  
Fancy thread guide No. 96-780 080-90 required in addition  
Guide-corde n° 96-780 080-90 nécessaire en plus  
La guía para cordoncillo N° 96-780 080-90 se requiere adicionalmente

[3] = Nähmuster einsenden  
= Submit sewing sample  
= Joindre échantillons de couture  
= Enviese muestra de costura

[2] = Eingeklammerte Zahl = Standardmaß, sonstige nach Bestellung  
= Number in parentheses = standard dimension; other dimensions on order  
= Chiffre entre parenthèses = mesure standard; autres mesures sur commande  
= Cifra entre paréntesis = medida estándar; otras medidas, sobre demanda

[2] = Sonderausführung  
= Special version  
= Version spéciale  
= Tipo especial

**Equipement des sous-classes  
Unterklassen-Ausstattung**

**Dotación de las subclases  
Subclass organization**

Maschinenklasse Machine class Classe de machine Clase de máquina	Greifer Looper Boucleur Garfio	Greifer hinten Looper rear Boucleur arrière Garfio detrás	Nadelanschlag Needle stop Pare-aiguille Tope de la aguja	Stoffanschlag Fabric guide Guide-bord Guía tope	Appareil [1][2][7] Attachment Appareil Aparato	Träger Bracket Support Soporte	Staumwinkel Hem guide Guide-bord Guía tope	Gummibandführung Elastic tape guide Guide-élastique Guía para elásticos	Fingerschutz Finger guard Protège-doigts Salvadoedos
<b>51</b>									
-23300-01 -990/01	96-712 082-05		96-707 394-05	96-712 093-25					96-707 1
<b>53</b>									
-23100-01 (-990/01)	96-712 082-05		96-707 394-05	96-705 459-25			96-710 427-25		96-707 1
-23100-01 (-990/01)	96-712 082-05		96-707 394-05	96-705 459-25			96-710 427-25		96-707 1
-23100-01 (-990/02)	96-712 082-05		96-707 394-05	96-705 459-25			96-710 427-25		96-707 1
-23100-01 (-990/01)	96-712 082-05		96-707 394-05	96-705 459-25			96-710 427-25		96-707 1
-23100-02 (-990/01)	96-712 082-05		96-707 394-05	96-705 459-25 96-712 109-21					96-707 1
-23300-01 (-990/01)	96-712 082-05		96-707 394-05	96-705 459-25			96-710 427-25		96-707 1
-23300-01 (-990/01)	96-712 082-05		96-707 394-05	96-705 459-25			96-710 427-25		96-707 1
-23300-01	96-712 082-05		96-707 394-05	96-705 459-25			96-710 427-25		96-707 1
-23300-011 -990/01 (-990/02)	96-712 082-05		96-707 394-05	96-705 459-25			96-710 427-25		96-707 1
-23300-02 (-990/01)	96-712 082-05		96-707 394-05	96-705 459-25 96-712 109-21					96-707 1
-23300-02 (-990/01)	96-712 082-05		96-707 394-05	96-705 459-25 96-712 109-21					96-707 1
-23500-020 -990/01	96-712 082-05		96-707 394-05	96-712 109-21					96-707 1
-24301-01	96-712 082-05		96-707 394-05	96-705 459-25			96-710 427-25		
-34300-01 (-990/01)	96-712 082-05		96-707 394-05	96-705 459-25 96-712 109-21					96-707 1
-35303-01	96-712 082-05		96-702 599-05	96-705 459-25			96-703 857-25		96-707 1
-35303-02	96-712 082-05		96-702 599-05	96-705 459-25			96-703 857-25		96-707 1
<b>55</b>									
-23300-41 -990/01	96-712 082-05		96-707 394-05	96-705 160-05		96-706 995-91		96-705 529-91	96-707 1
-23370-41 (-990/01)	96-712 082-05		96-707 394-05	96-705 160-05		96-706 995-91		96-705 529-91	96-707 1
-23370-41 -990/01	96-712 082-05	96-702 597-05	96-707 394-05	96-705 160-05		96-706 995-91		96-705 529-91	96-707 1
-23500-01	96-712 082-05	96-702 597-05	96-707 394-05		96-712 119-91	96-706 017-55			96-707 1

\*\* siehe Abbildung  
see illustration  
voir figure  
véase figura

 = Abbildung siehe Bestandsliste  
= For illustration see spare parts catalogue  
= Figure, voir liste de pièces détachées  
= Figura, véase la lista de piezas de recambio

Unterklassen-Ausstattung

Subclass organization

Equipement des sous-classes

Dotación de las subclases

Maschinenklasse Machine class Classe de machine Clase de máquina	Fadenführer Thread lubricator Huileur de fil Lubricador del hilo	Stoffabfallkanal Fabric chute Goulotte d'évacuation Conducto para recortes	Hakenmesser Hook knife Couteau-crochet Cuchilla de gancho	Untermesser Lower knife Couteau inférieur Cuchilla inferior	Roller hinten Guide roll, rear Galet à l'arrière Rodillo detrás	Roller vorn Guide roll, front Galet à l'avant Rodillo delante	Stretchbarge Stretch tool Barre d'étirage Barra para dar de sí	Zughebel Control lever Tirant Palanca de tracción
<b>51</b>								
-23300-01 -990/01								
<b>53</b>								
-23100-01 (-990/01)								
-23100-01 (-990/01) (-990/02)								
-23100-01 (-990/01)								
-23100-02 (-990/01) (-990/02)	96-780 014-91							
-23300-01 (-990/01)								
-23300-01								
-23300-011 -990/01 (-990/02)								
-23300-02 (-990/01)	96-780 014-91							
-23300-02 (-990/01)	96-780 014-91							
-23500-020 -990/01	96-780 014-91							
-24301-01								
-34300-01 (-990/01)								
-35303-01								
-35303-02								
<b>55</b>								
-23300-41 -990/01					96-702 069-91	96-707 055-91		
-23370-41 (-990/01)		96-706 749-21 96-710 715-51	96-705 142-05	96-705 138-05	96-702 069-91	96-707 055-91		
-23370-41 -990/01		96-706 749-21 96-710 715-51	96-705 142-05	96-705 138-05	96-702 069-91	96-707 055-91		
-23500-01							96-703 496-91	96-750 253-

Fortsetzung siehe nächste Seite  
Continued on next page  
Suite voir page suivante  
Continúa en la página siguiente

## Unterklassen-Ausstattung

## Subclass organization

### Equipement des sous-classes

### Dotación de las subclases

Maschinenklasse Machine class Classe de machine Clase de máquina	Nadelabstand in mm Needle gauge in mm Ecartement des aiguilles Distancia entre agujas en mm	Nadelhalter Needle holder Pince-aiguille Portaaguja	Stoffschieber Feed dog Griffe Transportador inferior	Stoffschieber, hinten Feed dog, rear Griffe Transportador inferior detrás	Stoffschieber, vorn Feed dog, front Griffe Transportador inferior delante	Stichplatte Stitch plate Plaque à aiguille Placa de aguja	Stoffdrückerfuß Presser foot Pied presseur Pie prensateelas
<b>55</b> -23500-01 (-990/01)	4,5	96-702 036-91	96-711 503-05 96-711 502-05 <sup>71</sup>			96-711 443-05	96-711 438-91
-23500-01 -990/01	6,0	96-702 044-91	96-707 258-05			96-707 257-05	96-707 255-91
-23500-02 -990/01	3,5	96-702 034-91	96-711 503-05			96-711 442-05	96-711 437-91
-23500-02 (-990/01)	4,5	96-702 036-91	96-711 503-05			96-711 443-05	96-711 438-91
-23500-04 -990/01	4,5	96-702 036-91	96-711 503-05 96-711 502-05 <sup>71</sup>			96-711 443-05	96-711 438-91
-23500-05 -990/01	4,5	96-702 036-91	96-706 151-05			96-706 101-05	96-706 125-91
-23500-06 -990/01	3,5	96-702 034-91	96-711 503-05 96-711 502-05 <sup>71</sup>			96-711 442-05	96-711 036-91
-23500-06 -990/01	4,5	96-702 036-91	96-711 503-05 96-711 502-05 <sup>71</sup>			96-711 443-05	96-711 037-91
-34300-41	5,4	96-702 030-91		96-702 635-05	96-702 616-05	96-705 749-05	96-707 854-91 96-705 530-91 <sup>71</sup>
-34300-45* (-990/01) (-990/02)	5,4	96-702 030-91		96-712 116-05	96-712 117-05	96-712 114-05	96-705 530-91 <sup>71</sup>
-34370-41 (-990/01)	5,4	96-702 030-91		96-702 635-05	96-702 616-05	96-702 618-05	96-707 854-91 96-705 530-91 <sup>71</sup>
-34370-410 (-990/01) (-990/02)	5,4	96-702 030-91		96-702 635-05	96-706 807-05	96-706 806-05	96-705 530-91
-35301-41	5,4	96-702 030-91		96-702 635-05	96-702 616-05	96-705 749-05	96-707 856-91
-35301-45*	5,4	96-702 030-91		96-712 116-05	96-712 117-05	96-712 114-05	96-702 051-91
-35371-41	5,4	96-702 030-91		96-702 635-05	96-702 616-05	96-706 618-05	96-707 856-91

\* Zusätzlich Kniehebel Nr. 96-712 113-90 erforderlich  
Knee-lever No. 96-712 113-90 required in addition  
Genouillère n° 96-712 113-90 nécessaire en plus  
La palanca de rodilla N° 96-712 113-90 se requiere adicionalmente

<sup>1</sup> = Nähmuster einsenden  
= Submit sewing sample  
= Joindre échantillons de couture  
= Enviese muestra de costura

<sup>71</sup> = Eingeklammerte Zahl = Standardmaß, sonstige nach Bestellung  
= Number in parentheses = standard dimension; other dimensions on order  
= Chiffre entre parenthèses = mesure standard; autres mesures sur commande  
= Cifra entre paréntesis = medida estándar; otras medidas, sobre demanda

<sup>71</sup> = Sonderausführung  
= Special version  
= Version spéciale  
= Tipo especial

# Unterklassen-Ausstattung

# Subclass organization

Maschinenklasse Machine class Classe de máquina	Greifer Looper Boucleur Garfo	Nadelanschlag Needle stop Para alquille Tope de la aguja	Stoffanschlag Fabric guide Guide-board Guía tope	Apparat [5] [7] [7] Attachment Appareil Aparato	Träger Bracket Support Supporte	Saumwinkel Hem guide Guide-board Guía tope	Gummibandführung Elastic tape guide Guide-Attachment Guip para elásticos	Fingerschutz Finger guard Protège-doigts Salvadedos	Fadenführer Thread lubricator Huileur de fil Lubricador del hilo
-23500-01 (-990/01)	96-712 082-05	96-707 394-05		96-712 119-91	96-706 017-55			96-707 139-15	
-23500-01 -990/01	96-712 082-05	96-707 394-05		96-712 119-91	96-706 017-55			96-707 139-15	
-23500-02 -990/01	96-712 082-05	96-707 394-05		96-705 648-91	96-705 489-55			96-707 139-15	96-780 014-91
-23500-02 (-990/01)	96-712 082-05	96-707 394-05		96-705 648-91	96-705 489-55			96-707 139-15	96-780 014-91
-23500-04 -990/01	96-712 082-05	96-707 394-05			96-706 017-55	96-705 254-91	96-705 556-91	96-707 139-15	
-23500-05 -990/01	96-712 082-05	96-707 394-05		96-712 119-91	96-706 017-55			96-707 139-15	
-23500-06 -990/01	96-712 082-05	96-707 394-05			96-706 017-55	96-705 254-91	96-705 556-91	96-707 139-15	
-23500-06 -990/01	96-712 082-05	96-707 394-05			96-706 017-55	96-705 254-91	96-705 556-91	96-707 139-15	
-34300-41	96-712 082-05	96-707 394-05	96-705 160-05		96-706 995-91		96-705 529-91	96-707 139-15	
-34300-45* (-990/01) (-990/02)	96-712 082-05	96-707 394-05		96-701 387-91 (85 x 35)	96-706 995-91			96-707 139-15	
-34370-41 (-990/01)	96-712 082-05	96-707 394-05	96-705 160-05		96-706 995-91		96-705 529-91	96-707 139-15	
-34370-410 (-990/01) (-990/02)	96-712 082-05	96-707 394-05	96-705 160-05		96-706 995-91			96-707 139-15	
-35301-41	96-712 082-05	96-707 394-05	96-705 160-05		96-706 995-91		96-705 529-91		
-35301-45*	96-712 082-05	96-707 394-05		96-702 658-91 (60 x 30)	96-706 995-91				
-35371-41	96-712 082-05	96-707 394-05	96-705 160-05		96-706 995-91		96-705 529-91		

Weitere Umbauteile bitten wir aus der Bestandteilliste zu entnehmen  
 For additional conversion parts please refer to the spare parts catalogue  
 Pour les autres pièces de transformation, voir liste de pièces détachées  
 Para las otras piezas de transformación, véase la lista de piezas de recambio

\*\* siehe Abbildung  
 see illustration  
 voir figure  
 véase figura

 = Abbildung siehe Bestandteilliste  
 = For illustration see spare parts catalogue  
 = Figure, voir liste de pièces détachées  
 = Figura, véase la lista de piezas de recambio

**Unterklassen-Ausstattung**  
**Equipement des sous-classes**

**Subclass organization**  
**Dotación de las subclases**

Maschinenklasse Machine class Classe de machine Clase de máquina	Schneidteilname Fabric name Fabrica Conducto para recortas	Hakenmesser Hook knife Couteau-crochet Cuchilla de garcho	Untermesser Lower knife Couteau inférieur Cuchilla inferior	Rolle hinten Guide roll, rear Galet à l'arrière Rodillo detrás	Rolle vorn Guide roll, front Galet à l'avant Rodillo delante	Streckstange Stretch rod Barre d'étirage Barra para dar de sí	Zughebel Control lever Tirant Palanca de tracción	Niederhalter Work retainer Pied de maintien Pie de retención
<b>55</b>								
-23500-01 (-990/01)						96-703 496-91	96-750 253-92	
-23500-01 -990/01						96-703 496-91	96-750 253-92	
-23500-02 -990/01							96-781 051-91	
-23500-02 (-990/01)							96-781 051-91	
-23500-04 -990/01						96-703 496-91	96-750 253-92	
-23500-05 -990/01						96-703 496-91	96-750 253-92	
-23500-06 -990/01						96-703 496-91	96-750 253-92	
-23500-06 -990/01						96-703 496-91	96-750 253-92	
-34300-41				96-702 069-91	96-707 055-91			
-34300-45* (-990/01) (-990/02)				96-702 069-91	96-707 055-91			
-34370-41 (-990/01)	96-706 749-21 96-710 715-51	96-705 142-05	96-705 138-05	96-702 069-91	96-707 055-91			
-34370-410 (-990/01) (-990/02)	96-706 749-21 96-710 715-51	96-705 142-05	96-705 138-05	96-702 069-91	96-707 055-91			96-707 287-91
-35301-41				96-702 069-91	96-707 055-91			
-35301-45*				96-702 069-91	96-707 055-91			
-35371-41	96-706 749-21 96-710 715-51	96-705 142-05	96-705 138-05	96-702 069-91	96-707 055-91			



96-702 030-91

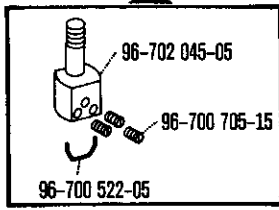

53-34300-01  
 55-34300-41  
 55-34300-45  
 55-34370-41  
 55-34370-410  
 55-35301-41  
 55-35301-45  
 55-35371-41

96-702 034-91

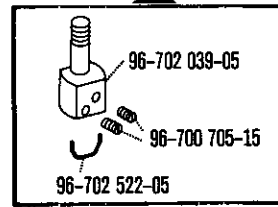

53-23100-01  
 53-23300-01  
 53-23300-02  
 55-23370-41  
 55-23500-01  
 55-23500-02  
 55-23500-06

96-702 036-91

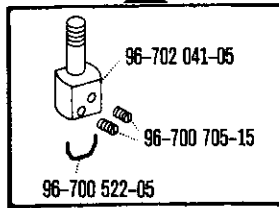

53-23100-01  
 53-23100-02  
 53-23300-01  
 53-23300-011  
 53-23300-02  
 53-23500-020  
 53-24301-01  
 55-23300-41  
 55-23370-41  
 55-23500-01  
 55-23500-02  
 55-23500-04  
 55-23500-05  
 55-23900-06

96-702 044-91

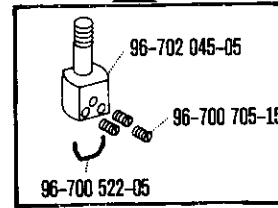

51-23300-01  
 53-23100-01  
 53-23300-01  
 55-23500-01

96-702 073-91

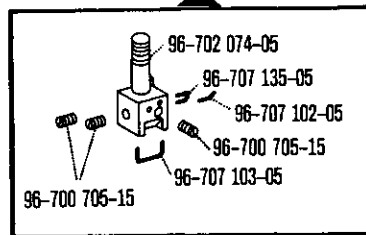

53-35303-01  
 53-35303-02

96-706 151-05



55-23500-05

96-707 258-05



55-23500-01

96-710 550-05



53-23100-01

96-711 454-05



53-23100-02  
 53-23500-020

96-711 502-05

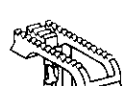

55-23500-01  
 55-23500-04  
 55-23500-06

96-711 503-05

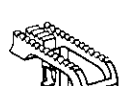

55-23500-01  
 55-23500-02  
 55-23500-04  
 55-23500-06

96-712 108-05

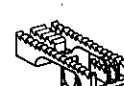

53-23100-01

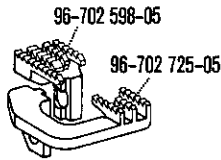
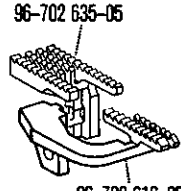
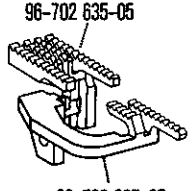
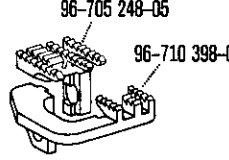
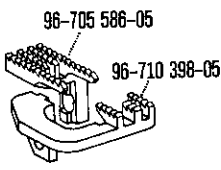
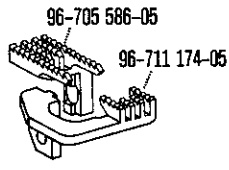
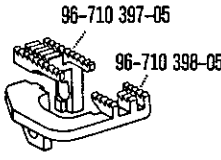
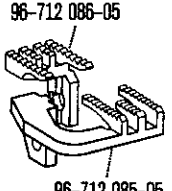
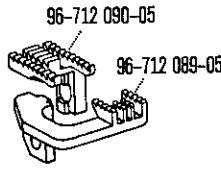
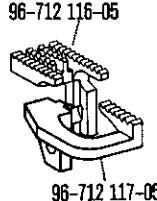
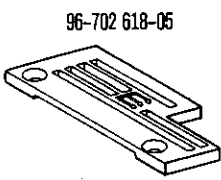
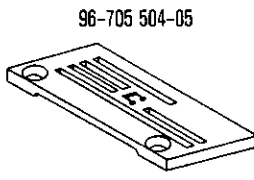
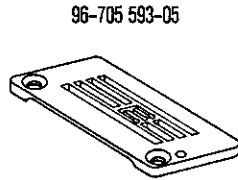
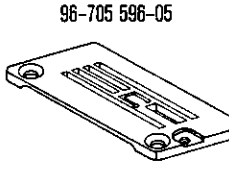
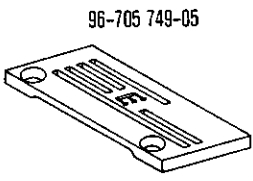
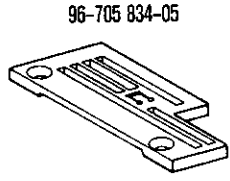
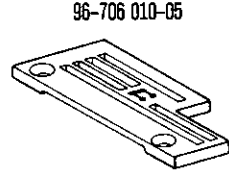
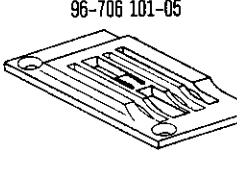
 <p>96-702 598-05 96-702 725-05</p> <p>53-35303-01 53-35303-02</p>	 <p>96-702 635-05 96-702 616-05</p> <p>55-23300-41 55-34370-41 55-23370-41 55-35301-41 55-34300-41 55-35371-41</p>	 <p>96-702 635-05 96-706 807-05</p> <p>55-34370-410</p>	 <p>96-705 248-05 96-710 398-05</p> <p>53-23300-02</p>
 <p>96-705 586-05 96-710 398-05</p> <p>53-23300-01 53-24301-01</p>	 <p>96-705 586-05 96-711 174-05</p> <p>53-34300-01</p>	 <p>96-710 397-05 96-710 398-05</p> <p>53-23300-01</p>	 <p>96-712 086-05 96-712 085-05</p> <p>51-23300-01</p>
 <p>96-712 090-05 96-712 089-05</p> <p>53-23300-01</p>	 <p>96-712 116-05 96-712 117-05</p> <p>55-34300-45 55-35301-45</p>		
 <p>96-702 618-05</p> <p>55-34370-41 55-35371-41</p>	 <p>96-705 504-05</p> <p>55-23300-41</p>	 <p>96-705 593-05</p> <p>53-34300-01</p>	 <p>96-705 596-05</p> <p>53-23300-01 53-24301-01</p>
 <p>96-705 749-05</p> <p>55-34300-41 55-35301-41</p>	 <p>96-705 834-05</p> <p>55-23370-41</p>	 <p>96-706 010-05</p> <p>55-23370-41</p>	 <p>96-706 101-05</p> <p>55-23500-05</p>

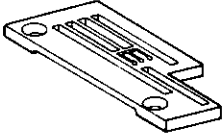
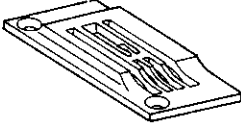
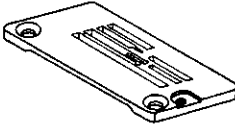
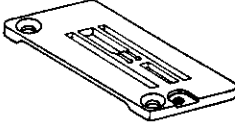
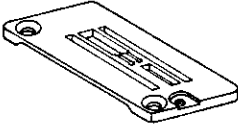
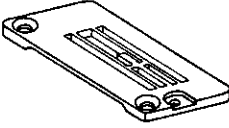
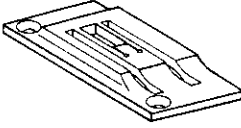
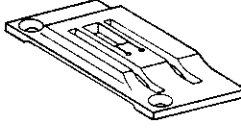
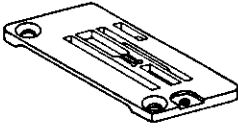
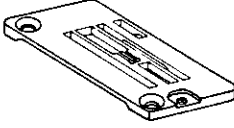
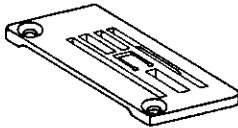
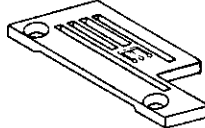
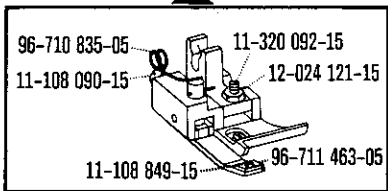
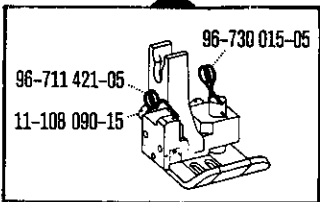
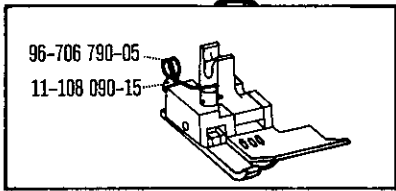
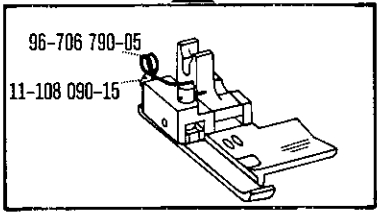
<p>96-706 806-05</p>  <p>55-34370-410</p>	<p>96-707 257-05</p>  <p>55-23500-01</p>	<p>96-711 152-05</p>  <p>53-35303-01 53-35303-02</p>	<p>96-711 423-05</p>  <p>53-23 100-01 53-23300-01</p>
<p>96-711 426-05</p>  <p>53-23 100-01 53-23300-01</p>	<p>96-711 434-05</p>  <p>53-23 100-01 53-23300-01</p>	<p>96-711 442-05</p>  <p>55-23500-01 55-23500-02 55-23500-06</p>	<p>96-711 443-05</p>  <p>55-23500-01 55-23500-02 55-23500-04 55-23500-06</p>
<p>96-711 452-05</p>  <p>53-23300-02</p>	<p>96-711 453-05</p>  <p>53-23 100-02 53-23300-02 53-23500-020</p>	<p>96-711 570-05</p>  <p>51-23300-01</p>	<p>96-712 114-05</p>  <p>55-34300-45 55-3530 1-45</p>
<p>96-702 051-91</p>  <p>55-3530 1-45</p>		<p>96-703 668-91</p>  <p>53-23500-020</p>	
<p>96-705 530-91</p>  <p>55-34300-41 55-34300-45 55-34370-41 55-34370-410</p>		<p>96-705 572-91</p>  <p>55-23300-41 55-23370-41</p>	

96-705 574-91

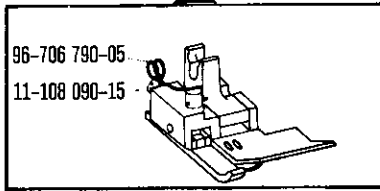

55-23370-41

96-705 600-91

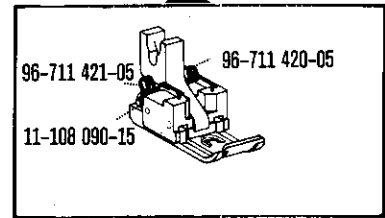

53-24301-01

96-706 095-91

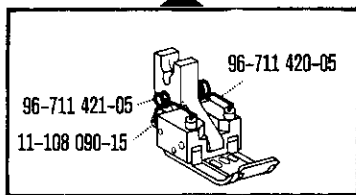

53-34300-01

96-706 125-91

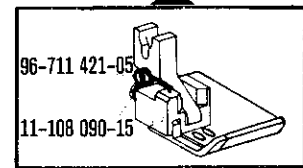

55-23500-05

96-707 105-91

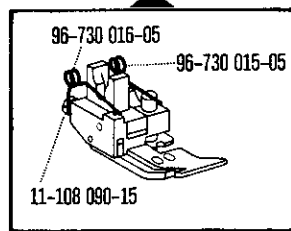

53-35303-01  
53-35303-02

96-707 255-91

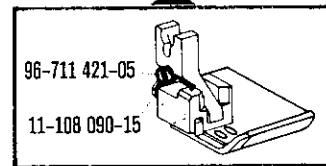

55-23500-01

96-707 458-91

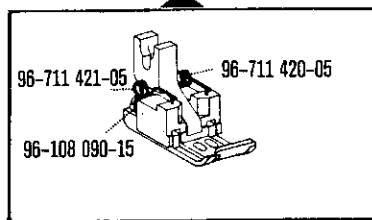

53-23300-011

96-707 852-91

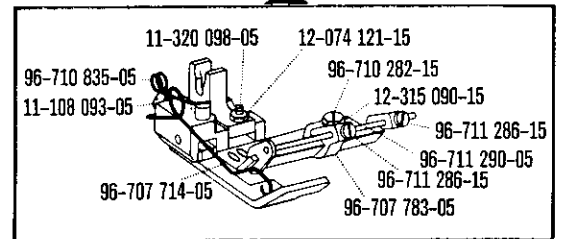

55-23370-41

96-707 853-91

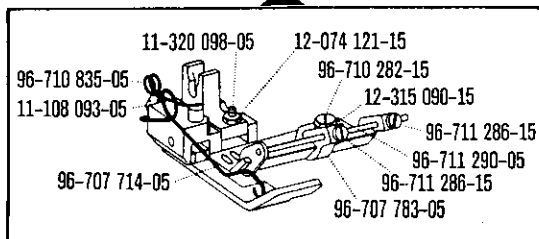

55-23370-41

96-707 854-91

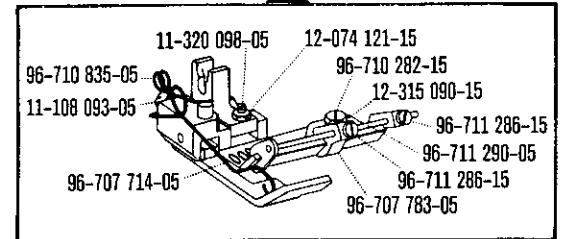

55-34300-41  
55-34370-41

96-707 856-91

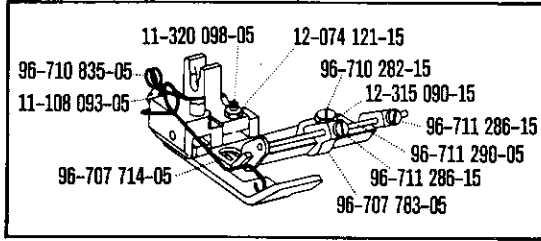

55-35301-41

55-35371-41

96-711 036-91

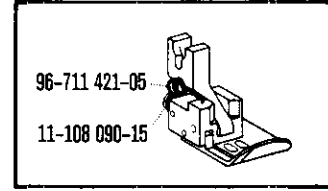

55-23500-06

96-711 037-91

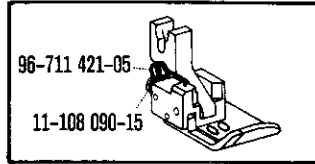

55-23500-06

96-711 415-91

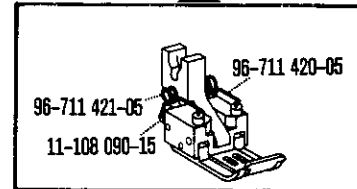

53-23 100-01  
53-23300-01

96-711 424-91

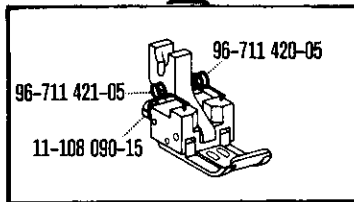

53-23 100-01  
53-23300-01

96-711 431-91

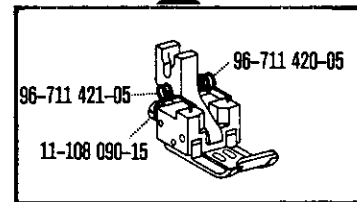

53-23 100-01  
53-23300-01

91-711 437-91

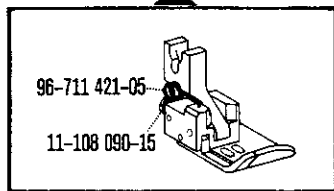

55-23500-01  
55-23500-02

96-711 438-91

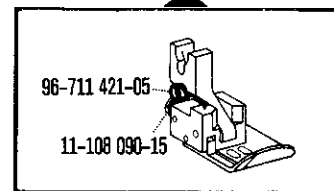

55-23500-01  
55-23500-02  
55-23500-04

96-711 445-91

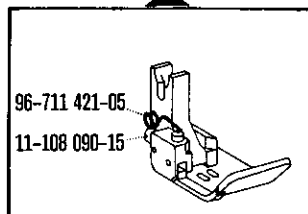

53-23300-02

96-711 446-91

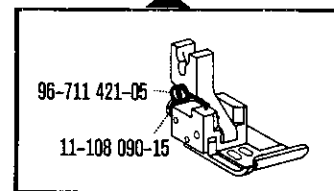

53-23 100-02  
53-23300-02

96-711 569-91

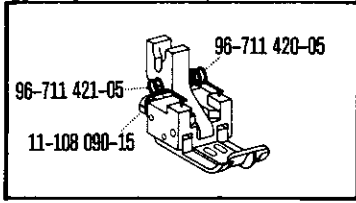

51-23300-01

96-721 221-93

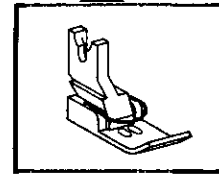

53-23 100-01  
53-23300-01

96-712 082-05



51-23300-01  
53-23 100-01  
53-23 100-02  
53-23300-01  
53-23300-01

53-23300-02  
53-23500-020  
53-2430 1-01  
53-34300-01  
53-35303-01

53-35303-02  
55-23300-41  
55-23370-41  
55-23500-01  
55-23500-02  
55-23500-04  
55-23500-05  
55-23500-06

55-34300-41  
55-34300-45  
55-34370-41  
55-34370-410  
55-3530 1-41  
55-3530 1-45  
55-3537 1-41

96-702 597-05

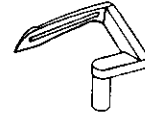

55-23370-41  
55-23500-01

96-702 599-05



11-108 090-15

53-35303-01  
53-35303-02

96-707 394-05



11-108 090-15

51-23300-01  
53-23 100-01  
53-23 100-02  
53-23300-01

53-23300-01  
53-23300-02  
53-23500-020  
53-2430 1-01

53-34300-01  
55-23300-41  
55-23370-41  
55-23500-01  
55-23500-02  
55-23500-04  
55-23500-06

55-23500-06  
55-34300-41  
55-34300-45  
55-34370-41  
55-34370-410  
55-3530 1-41  
55-3530 1-45  
55-3537 1-41

96-705 160-05

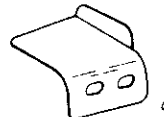

96-710 189-15

55-23300-41  
55-23370-41  
55-34300-41  
55-34370-41

55-34370-410  
55-3530 1-41  
55-3537 1-41

96-702 292-15

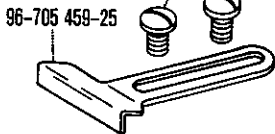

53-23 100-01  
53-23 100-02  
53-23300-01  
53-23300-01  
53-23300-02

53-2430 1-01  
53-34300-01  
53-35303-01  
53-35303-02

96-712 093-25

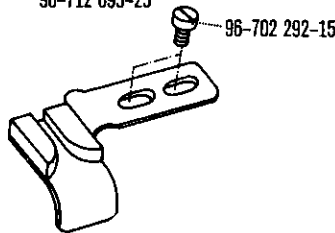

51-23300-01

96-712 109-25

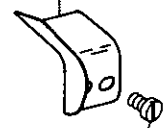

11-108 171-15

53-23 100-02  
53-23300-02  
53-23500-020  
53-34300-01

96-710 428-15



96-703 857-25

53-35303-01  
53-35303-02

96-705 254-91

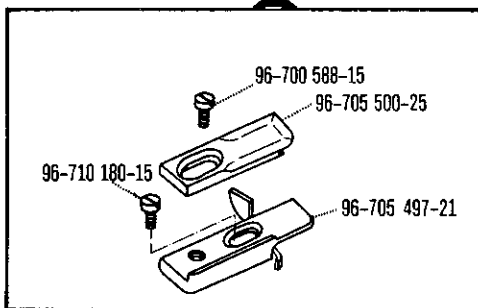

55-23500-04  
55-23500-06

96-710 428-15



96-710 427-25

53-23 100-01  
53-23300-01  
53-23300-01  
53-2430 1-01

96-701 387-91

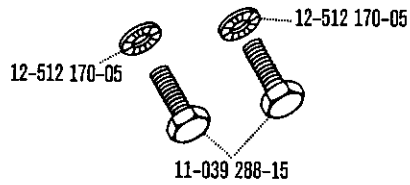
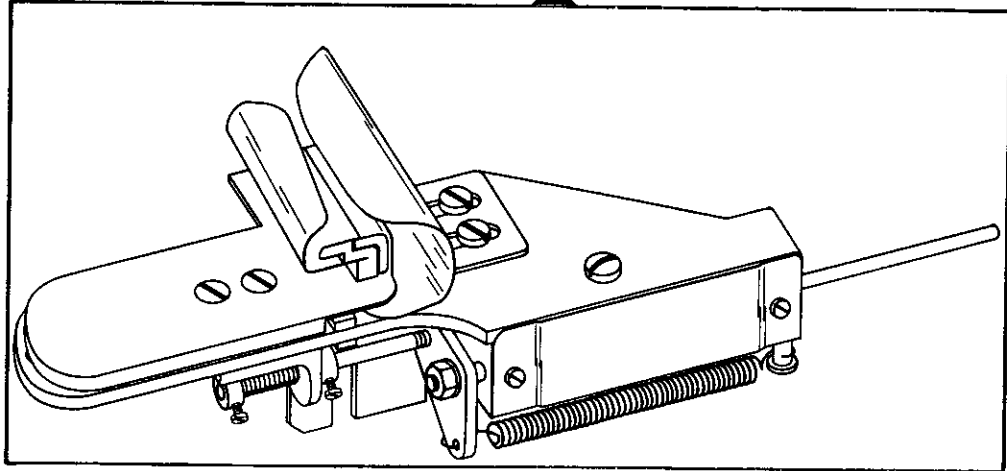

55-34300-45

96-702 658-91

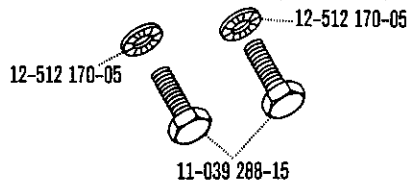
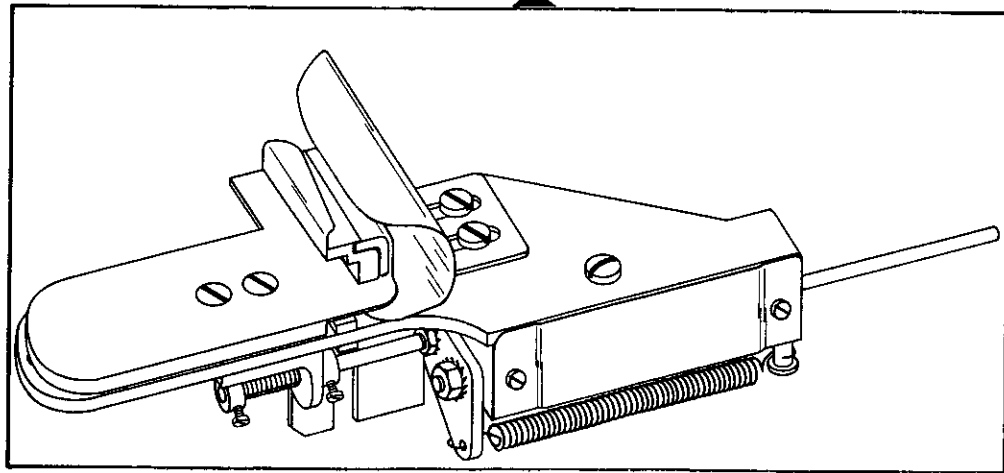

55-35301-41

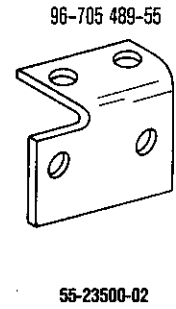
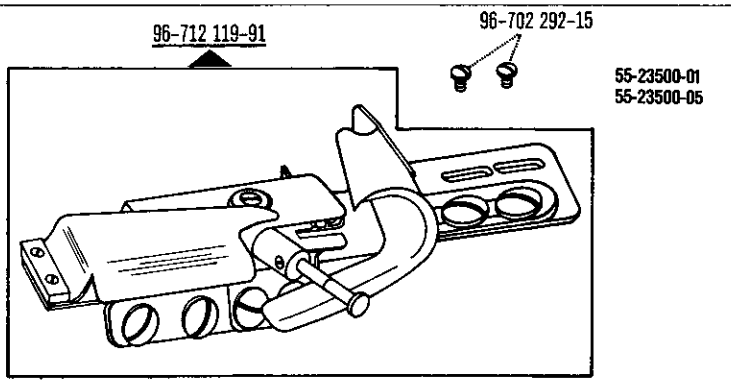
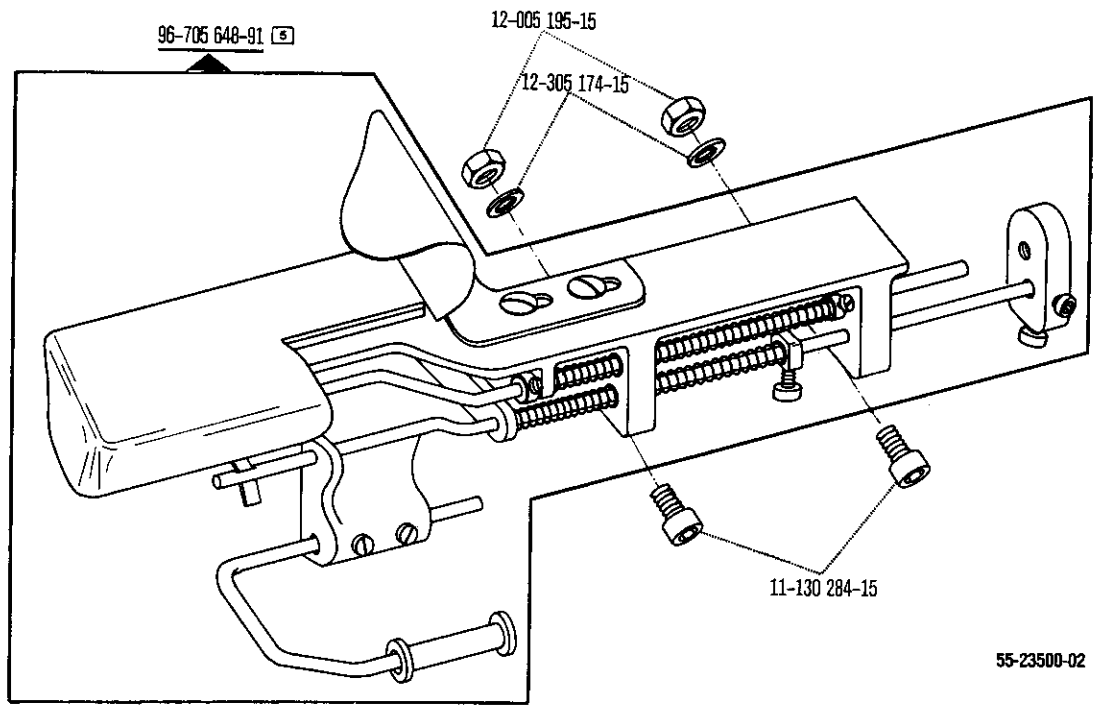

96-706 017-55

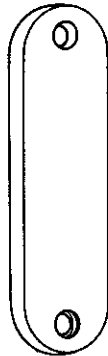

55-23500-01  
55-23500-04  
55-23500-05  
55-23500-06

96-706 995-91

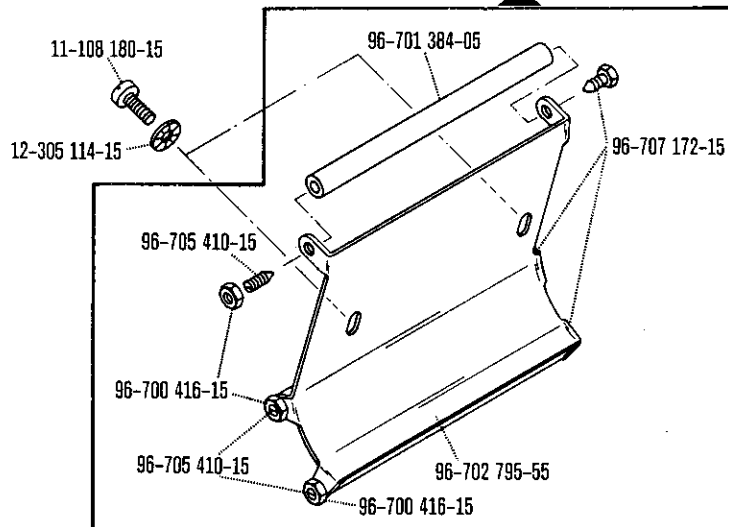

55-23300-41  
55-23370-41  
55-23370-41  
55-34300-41

55-34300-45  
55-34370-41  
55-34370-410

55-35301-41  
55-35301-45  
55-35371-41



96-705 529-91

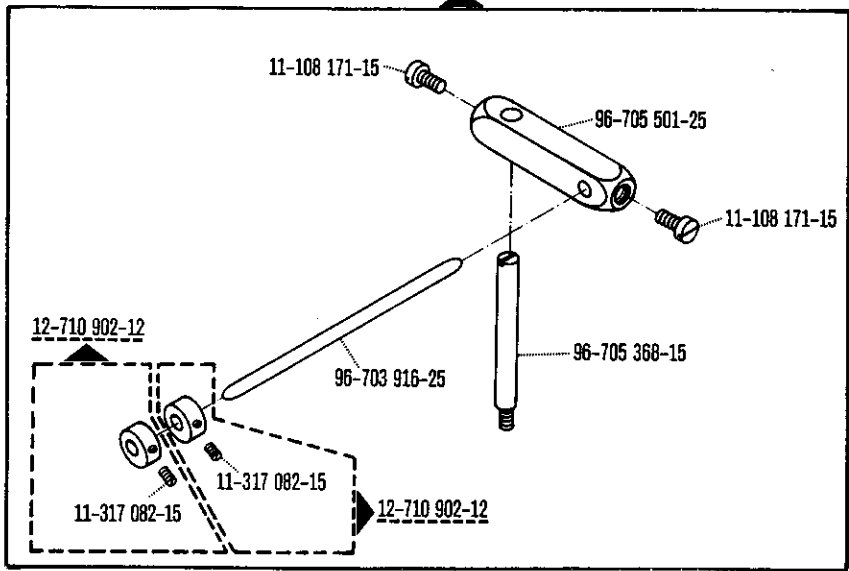

55-23300-41  
 55-23370-41  
 55-34300-41  
 55-34370-41  
 55-35301-41  
 55-35371-41

96-705 556-91

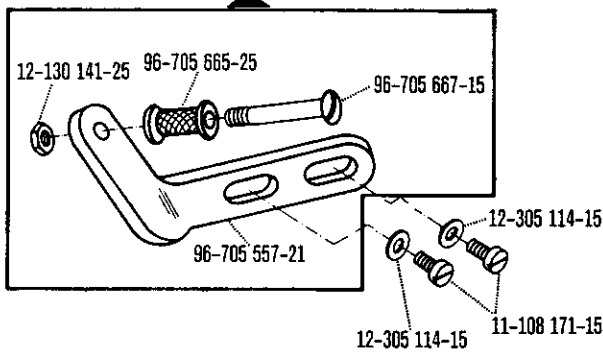

55-23500-04  
 55-23500-06

96-780 014-91

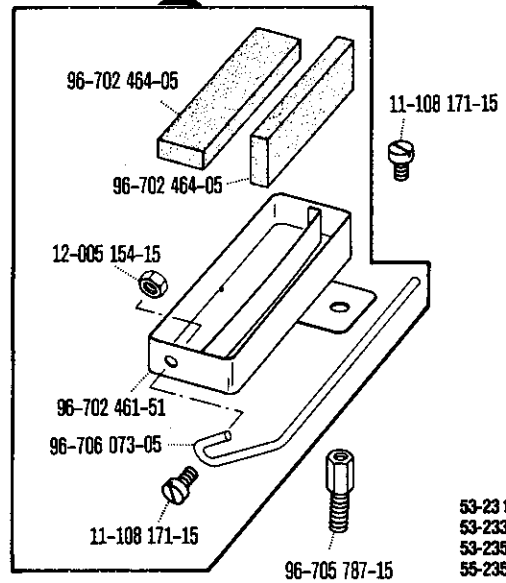

53-23 100-02  
 53-23300-02  
 53-23500-020  
 55-23500-02

96-706 749-21

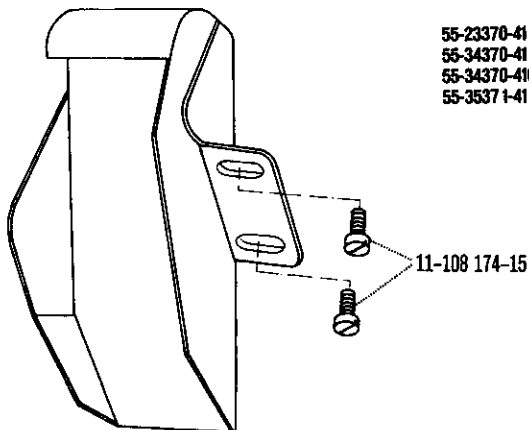

55-23370-41  
 55-34370-41  
 55-34370-410  
 55-35371-41

96-707 139-15

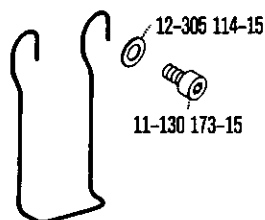

51-23300-01  
 53-23 100-01  
 53-23 100-02  
 53-23300-01  
 53-23300-011  
 53-23300-02  
 53-23500-020  
 53-2430 1-01  
 53-34300-01  
 53-35303-01  
 53-35303-02

55-23300-41  
 55-23370-41  
 55-23500-01  
 55-23500-01  
 55-23500-02  
 55-23500-04  
 55-23500-05  
 55-23500-06  
 55-34300-41  
 55-34300-45  
 55-34370-41  
 55-34370-410

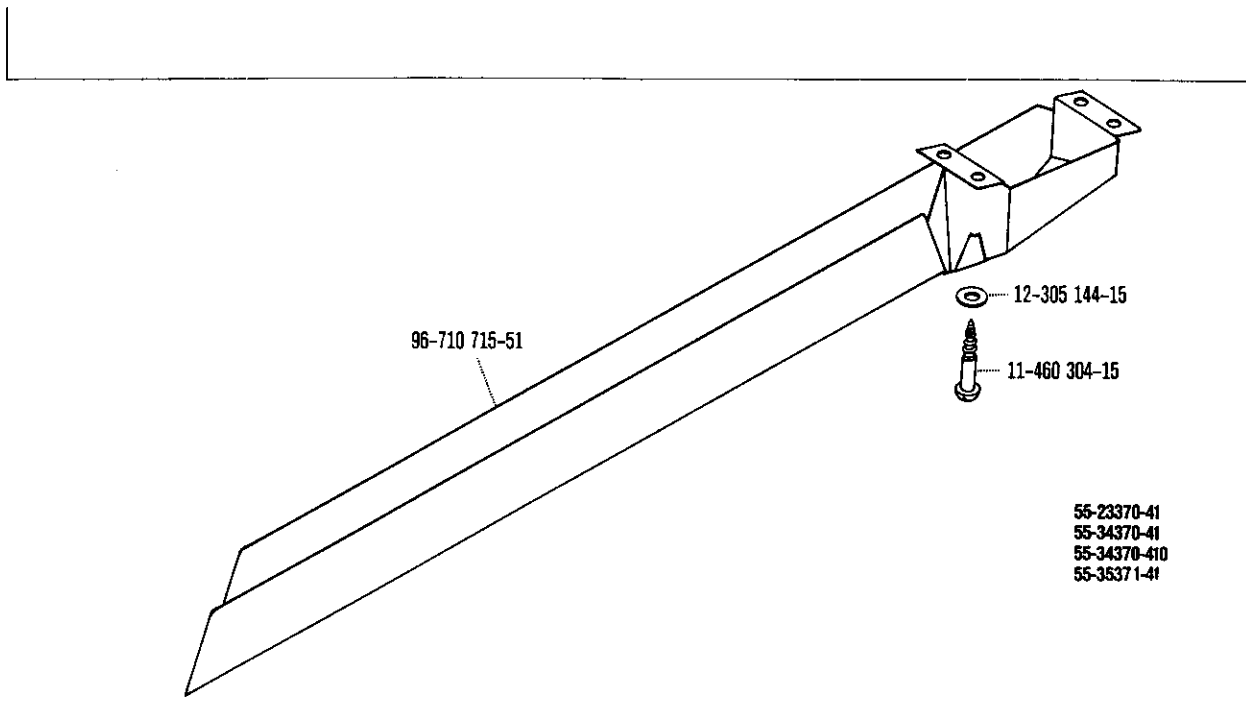

96-707 287-91

55-34370-410

