

# **GLOBAL**

## **BT 100x100**

**Instruction manual**

# 1 General Information

## 1.1 General Introduction

Mitsubishi series computerized control system for industrial sewing machine: 1) Adoption of the world leading AC servo control technology on main shaft motor provides large torque, high efficiency, stable speed and low noise; 2) Diversified design of control panel can meet the special requirements of users on attachment; 3) System adopts German style structure, which greatly facilitates the installation and maintenance.

## 1.2 Functions and Parameters

NO.	Type of Controller	Computerized Control System for Mitsubishi Series Pattern-sewing Machine
1	Sewing Area	X(Lateral) Direction    Y(Longitudinal) Direction SC442HG: 3000(mm)    x    1000(mm)
2	Max. Sewing Speed	2500rpm (with stitch interval below 3mm)
3	Stitch Length	0.1~12.7mm, and in the control system is of version 5.0 or above, the maximum stitch length can extend to 40 mm (Min Resolution: 0.10mm)
4	Feed Motion of Frame	Intermittent feeding (2-shaft driven by pulse motor)
5	Needle Bar Stroke	41.2mm
6	Needles	DP×5、DP×17
7	Lift of Frame	Standard 18mm to Max. 22mm (Pneumatic type: Max. 25mm)
8	Intermediate Presser	Stepping Driving (Range: 0~8mm)
9	Lift of Intermediate Presser	20mm
10	Rotating Shuttle	Double-capacity semi-rotary hook
11	Memory of Pattern Data	Memory/U Disk
12	Pause function	Stop the machine during the sewing
13	Scaling Up/Down Function	Allows a pattern to be scaled up/down on the X axis and Y axis independently when user sews a pattern. Ratio: 1% to 400% (0.1% per step)
14	Scaling Up/Down Method	Increasing / decreasing stitch length & Increasing / decreasing stitch number
15	Sewing Speed Limitation	200~2500rpm (100rpm per step)
16	Pattern Selection Function	Pattern No. selection method
17	Up counter	No Count/Count of Pattern /Count of Cycle (0~99999)
18	Down Counter	No Count/Count of Pattern /Count of Cycle (0~99999)

19	Sewing Machine Motor	Servo Motor
20	Stop Needle at Highest Position Function	After the completion of sewing, the needle can return to its highest position.
21	Rated Power	600W
22	Operation Temperature Range	0°C~45°C
23	Operation Humidity Range	35%~85% (No Dew Condensation)
24	Line Voltage	AC 220V ± 10%; 50/60Hz

※ Effective standard for product: QCYXDK0004—2016 Computerized Control System for Industrial Sewing Machine.

### 1.3 Matters for Safe Using

#### ● Installation

- Control Box
  - ◆ Please install the control box according to the instructions
- Attachments
  - ◆ If other attachments are needed, please turn off the power and pull out the power plug.
- Power Cable
  - ◆ Do not press power cables forcefully or twist power cable excessively.
  - ◆ The power cables shall be fixed at least 25mm away from the rotating component.
  - ◆ Before powering the control box, user shall carefully check the voltage of power supply and the position of power input on the control box. If the power transformer is used, user should also check it before powering the machine. The power switch of the sewing machine must be set as "Off".
- Grounding
  - ◆ In order to avoid the noise disturbance and electric shock caused by electric leakage, user should ground the grounding cable.
- Attachments
  - ◆ If any electric attachments are needed, please connect them to proper positions.
- Disassemble
  - ◆ When removing the control box, user must turn off the power and pull out the power plug.
  - ◆ When pulling out the power plug, user should hold the plug and remove it, instead of pulling the power cable only.
  - ◆ The control box contains the dangerous high voltage power. For opening the control box, please turn off the power and pull out the plug from socket first, and then wait for at least 5 minutes before opening the control box.

#### ● Maintenance, Inspection and Repair



- Only trained technicians can perform the repair and maintenance of this machine.



- When replacing the needles and shuttles, user should turn off the power.
- Please use the spare parts from the authorized manufacturers.
- **Others**
  - Do not touch the rotating or moving parts of the machine, especially the needle and belt, when the machine is working. User should also keep his/her hair away from those moving parts, so as to avoid the danger.
  - Do not drop the control device on the floor, nor insert any stuff into the slots on the control box.
  - Do not run the machine without the cover shells.
  - If this control device is damaged or unable to work normally, please ask the technicians to adjust or repair it. Do not run the machine when the problem is not solved.
  - Please do not change or modify this control device without authorization.
- **Abandonment**
  - Dispose it as common industrial trash.
- **Warning and Danger**
  - The mistake operation may cause danger. For the serious level, please refer to the figure below:

	<b>Warning</b> The wrong operation may cause serious injury or death
--	---

	<b>Caution</b> The wrong operation may cause personal injury or loss of property
---	---

- The meanings of the marks are shown below:

	Please operate machine according to instruction
	Caution: High Temperature
	Never do this

	Caution: High Voltage
	Grounding is a must

#### 1.4 The Preventive Measures in Use

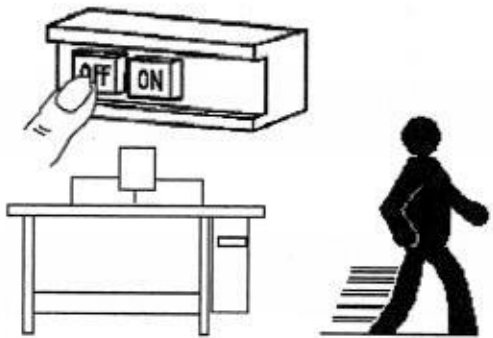
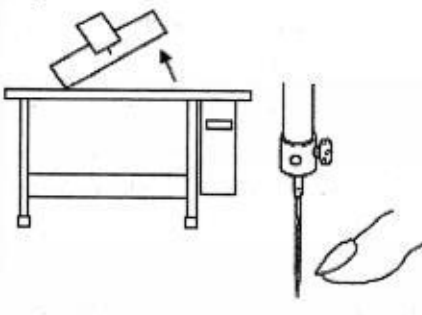
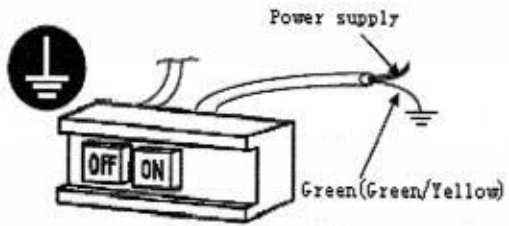
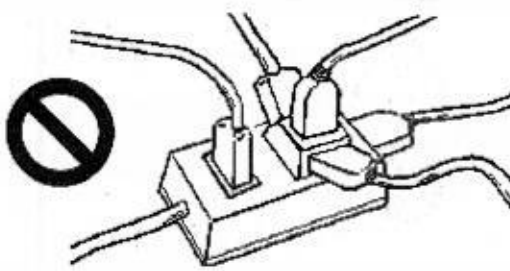
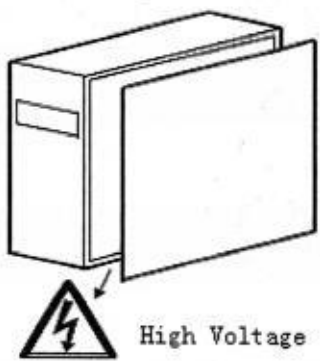

- |  |  |
|--|--|
| 1. When you press the switch [ON], please do not step the pedal. | 2. When you leave the machine, please turn it off. |
|--|--|

	
<p>3. If user needs to tilt the head or replace the needle or thread the upper thread, please turn off the power.</p> 	<p>4. Ground well the grounding cable.</p> 
<p>5. Do not use the household terminal block to let machines to share one power supply.</p> 	<p>6. For opening the control box, please turn off the power and pull out the plug from socket firstly, and then wait for at least 5 minutes before opening the control box.</p> 
<p>7. After replacing the motor, user has to adjust the main motor installation angle according to this manual.</p>	
<p>8. Please keep it away from the disturbance of high frequency machines.</p>	<p>9. If user needs the external signal socket to connect the attachments, the connecting wire shall be as short as possible. The long cable may cause mistake operations. And the connection cable shall be the shielded.</p>

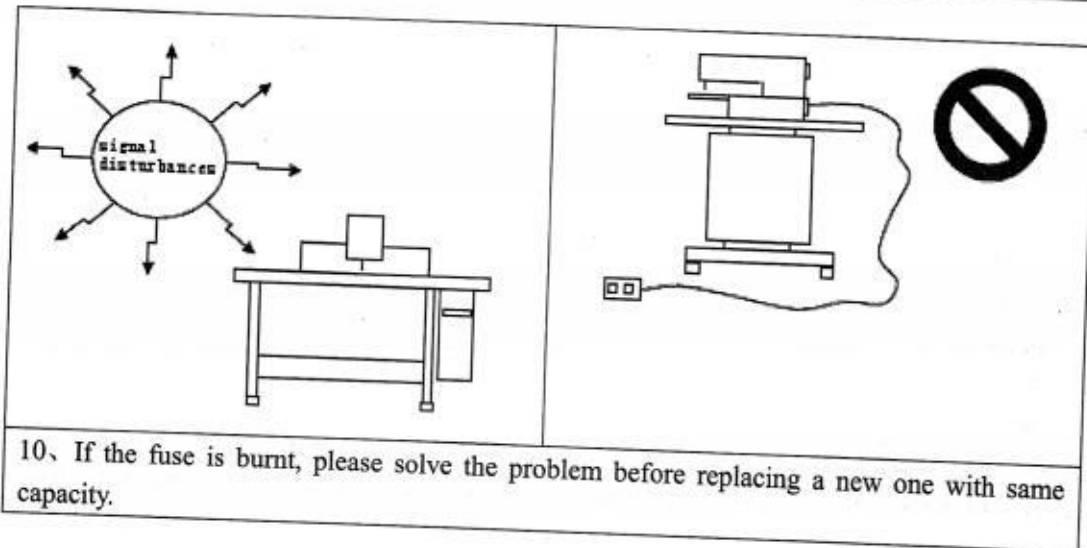

10. If the fuse is burnt, please solve the problem before replacing a new one with same capacity.

### 1.5 Standardization

The function keys use figures commonly recognized within the industry. Figures, as international language, are recognizable to users in every country.

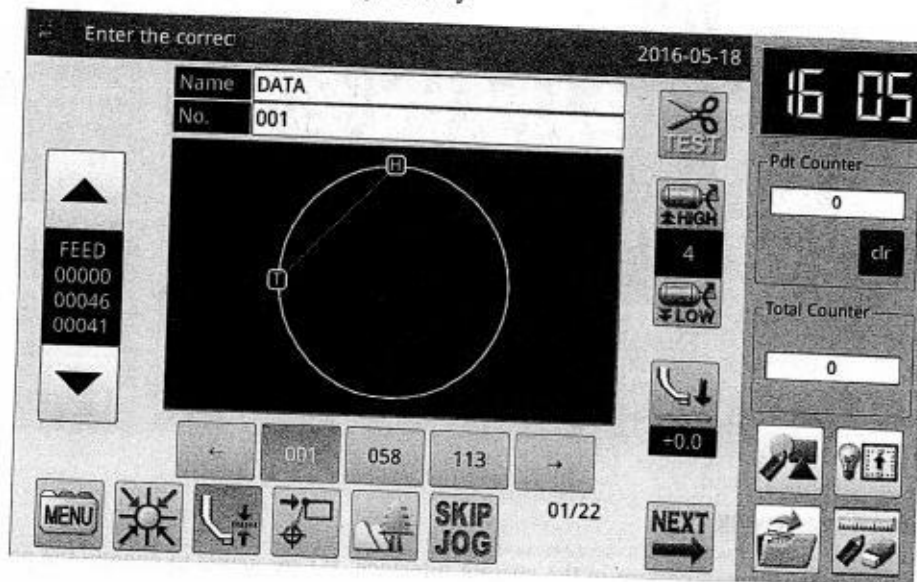

### 1.6 Operation Method

The Mitsubishi type touching panel adopts the advanced touching operation technology, whose user-friendly interface and easy control bring the revolutionary changes to the daily usage of the users. For performing relevant operations, user can use his fingers or other objects to touch the screen.



Don't use sharp objects to touch the screen so as to avoid causing permanent damage to the touch panel.

## 2 Operation Instructions

### 2.1 Basic Operation

#### 1、 Turn on Power Switch

After user turns on the power, the main interface P1 will be displayed.

**[Note]:** If the memory of system contains no pattern when user turns on the power, the system will display “Cannot Find Pattern in Memory”. At this moment, user needs to press

 to close the message and shift to the main interface.



#### 2、 Pattern for Sewing

Display the selected pattern in the current interface. If user wants to change the pattern, he should refer to section [2.5 Load Pattern].

#### 3、 Start Sewing

① Before the actual sewing, user need confirm the settings of the sewing conditions again, especially the setting of the speed (Range: 0~9).

② The speed of sewing machine is determined by the speed value and stitch interval. The speed value will determine the max speed of sewing machine, while the stitch interval will limit the speed of sewing machine.

**[Note]:** Do not change the speed value during the sewing, except the condition of pause, otherwise it may cause influence on the thread-withdrawing condition.

③ Put the sewing material to the appointed position, step the frame switch (black one) to lower the frame and step the running switch (grey one) to start the actual sewing. Once the

sewing starts, user will not need to continue stepping on the running switch. When the sewing machine finishes the work, the frame will go up automatically.

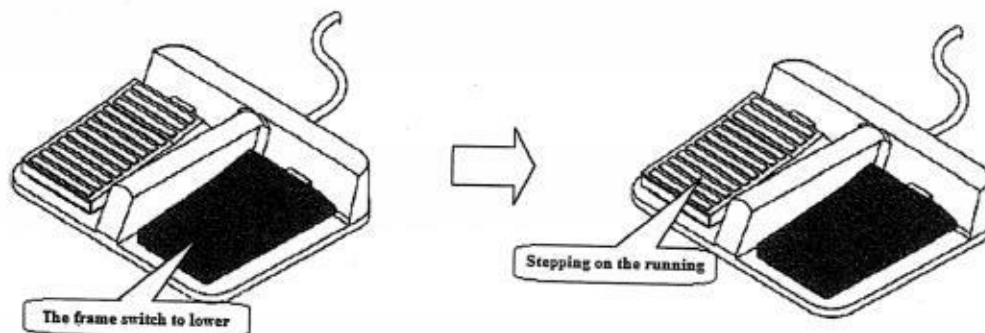

#### 4. Pause

If user wants to stop the machine during the sewing, please press the emergency stop button on the head (Please refer to the following figure for details). After user presses that key, the sewing machine will stop at the upper position (default setting) and enter the pause status. For releasing the pause status, please press that emergency stop button again. Then user can continue to perform the following operation:

- ① Step on the running switch to continue the sewing;
- ② Press Forward Moving/ Backward Moving to change the sewing start position;
- ③ Step on the frame switch to lift frame;
- ④ Change the speed value of sewing machine; and/or
- ⑤ Move the intermediate presser.

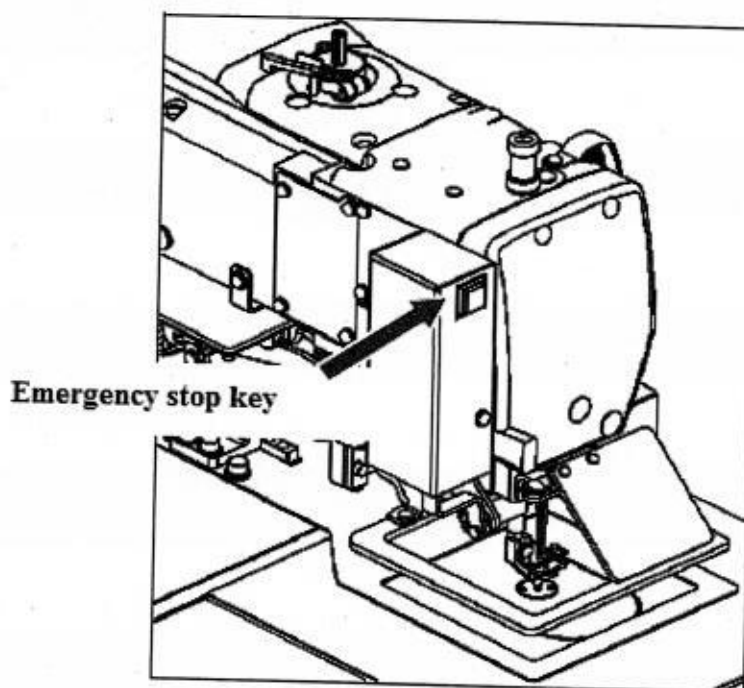

#### 5. Method for Mending the Sewing

User can use the pause function to perform the mending sewing. If user presses emergency stop key in case of thread-breakage, the needle will stop at the upper position. Press backward moving key to move the frame to the position that is two or three stitches before the thread-breakage point, finish threading and step the running switch to continue the sewing.



**Caution** When wearing a needle and thread, absolutely not trample operation switch with their feet, That can make the machine running, it is dangerous.

## 2.2 Instructions on Interface Display Status

### 2.2.1 Interface 1 (Main Interface P1: Standard Display Status)

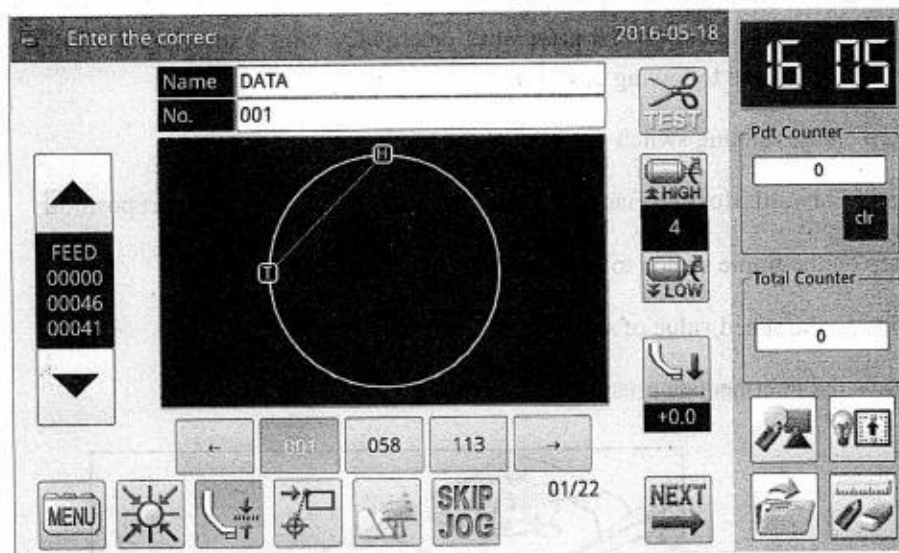

**[Note]** The comparison among Product Counter, Power-on Counter and Accumulation Counter:

- Product Counter is to record the accumulated sewing number. But user

can use  to clear the value and restart counting;

- Power-on Counter is to count number from 0 after the machine is turned on;
- Accumulation Counter is to record the accumulated sewing number, which can't be cleared in the current interface.

### 2.2.2 Interface 2 (Display Status after Users Press NEXT in Main Interface P1)

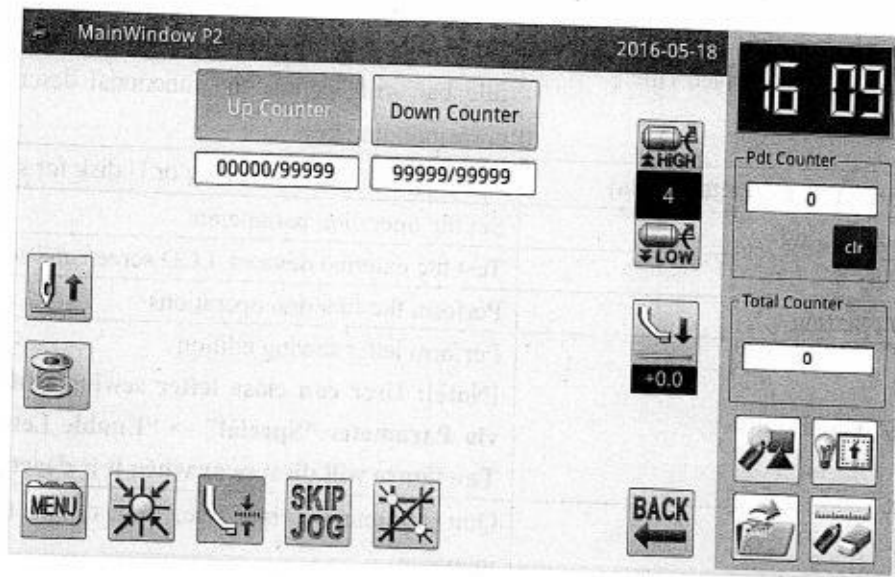

**2.2.3 Interface 3 (Catalogue Mode in Main Interface P1)**

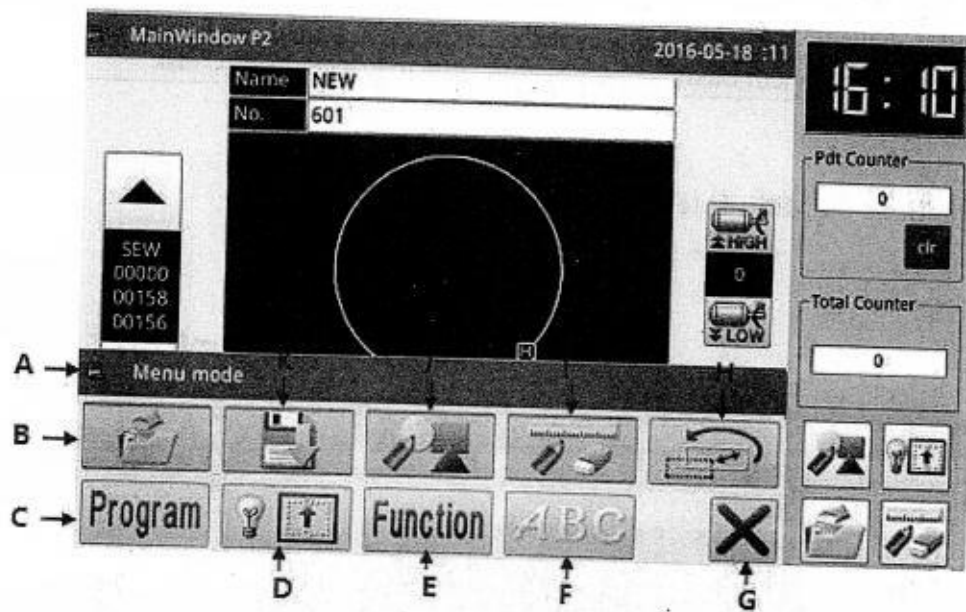



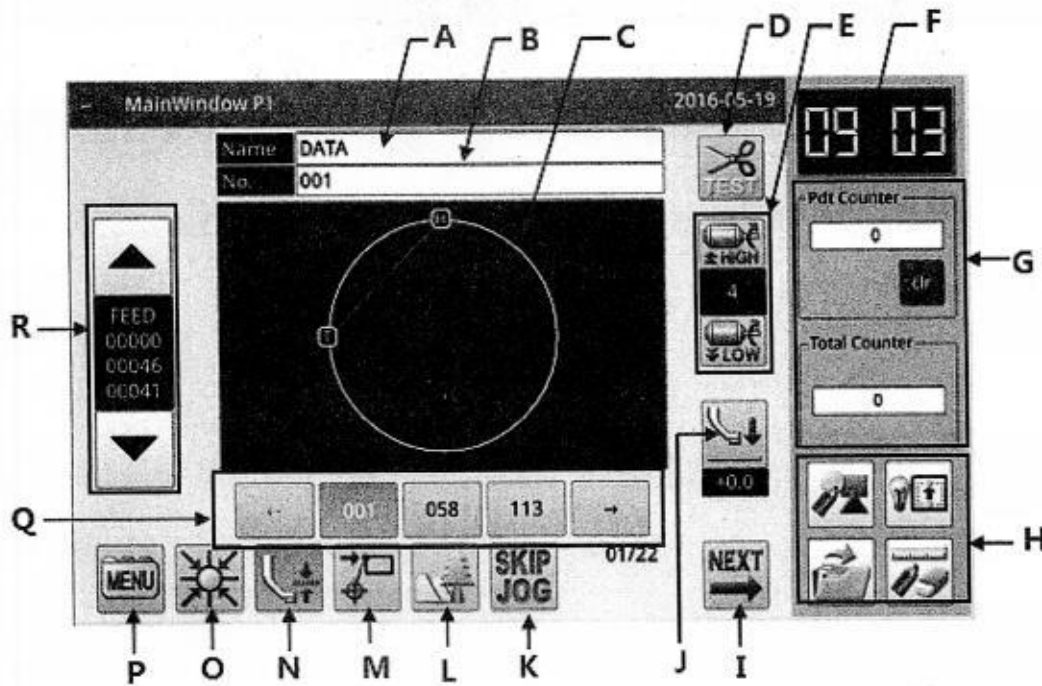

**Functions:**

No.	Function	Content
A	MENU Function Interface Title	The displayed content is the interface title of the MENU. When user press the button, the displayed content in the title bar will become the functional description of the corresponding key.
B	Load Pattern (Load Pattern Data)	Load a pattern from memory or U disk for sewing.
C	Operation Setting	Set the operation parameters
D	Test Mode	Test the external devices, LCD screen and so on.
E	Function Setting	Perform the function operations
F	Letter Sewing Edition	Perform letter sewing edition. [Note]: User can close letter sewing edition function via Parameter "Special" -> "Enable Letter Sewing". The figure will disappear when it is deactivated.
G	Quit	Quit the current interface, and return to the upper interface.
H	Data Transformation (File Transformation Mode)	Transform the data
I	Modify Pattern (Modification Mode)	Modify the pattern
G	Edit Pattern (Pattern Design Mode)	Edit the pattern
K	Save Pattern (Save Pattern Data)	Save the pattern to memory or U disk

**2.3 Instructions on Main Interface P1**



**Functions:**

No.	Functions	Content
A	Pattern Name	Display the name of current pattern
B	Pattern Number	Display the number of the current pattern
C	Pattern Shape	Display the shape of the current pattern [Note]:  is the position of origin.
D	Speed Adjustment Area	Adjust and display the sewing speed of the current pattern
E	Pattern Number Hot Key	Display the recently used pattern numbers, at most 40 numbers can be saved. Pressing the pattern number will activate that pattern for sewing. [Note]: In combined pattern sewing mode, the displayed content is the sub-pattern numbers and their number.
F	Hot Key Setting of Functions	User can set 4 frequently-used functions.
G	Enter Main Interface P2	Press it to enter Main Interface P2.
H	Move Intermediate Presser	Press the key to move the intermediate presser in the appointed direction.  : Press it to lift the intermediate presser  : Press it to drop the intermediate presser
I	Parameter Hot Key	Set parameters: start sewing bar-tacking method/start sewing bar-tacking stitches/end sewing bar-tacking method/robbin thread alarm stitches
J	Panel Lock	Lock and unlock the panel.
K	Fast Moving Setting	Enter the interface for setting fast moving.
L	Pattern Information Display	Display the shape and details of the current pattern
M	Back to Sewing Start	Press it to return to sewing start
N	Back to Origin	Press it to return to origin
O	MENU	Display the catalogue (refer to [2.2.2 Interface 2])
P	Product Counter and Robin Thread Counter	Product Counter: to record the accumulated sewing number, but user can use  to clear the value and restart counting; Robin Thread Counter:
Q	Pattern Stitch Number Display Area and Forward/Backward Moving Keys	Display the stitch number and perform the trial sewing.
R	Change Sewing Start	Change the position of sewing start.

**2.3.1 Pattern Stitch Number Display & Forward/ Backward Moving****Functions:**

No.	Descriptions
A	Display the current frame position and sewing data type.

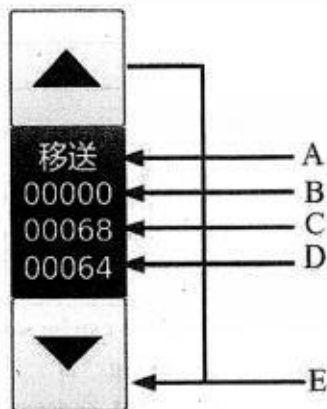

	(Sewing "SEW", Feed "FEED", Sub-origin "2HP", Upper Stop "USTP", Down Stop "DSTP", Thread-trimming "TRIM", Feed Speed "FEDS", Restart "ASRT", Board Heavy "HEVI", Fabric Thick "ATUM", Jump Sewing "BAT", Function 1 "FUN1"~Function 7 "FUN7", Reverse Presser Feet "REPF", End "END")
B	Display the stitch number at current position
C	Display the total stitch number of the current pattern (Including Feed, Thread-trimming, End, Code, etc.)
D	Display the total sewing stitch number of current pattern (Excluding Feed, Thread-trimming, End, Code, etc.)
E	Test Pattern (Forward / Backward): 1. After it returns to origin, X-Y (frame) will move forward on the pattern when users press the "Upper". Release the key to stop moving. Holding the "Down", the X-Y (frame) will move backward. Release the key to stop moving. 2. If the frame is at down position and the pattern is right, user can step the pedal to start sewing.

### 2.3.2 Speed Adjustment

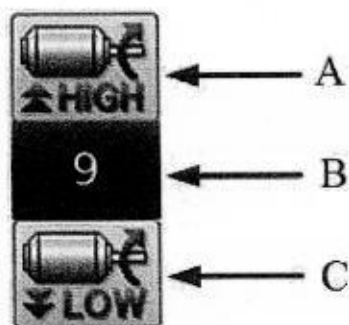

**Functions:**

No.	Description
A	Increase the speed
B	Current sewing speed (0~9)
C	Reduce the speed

### 2.3.3 Operation of Pattern Number Hotkey

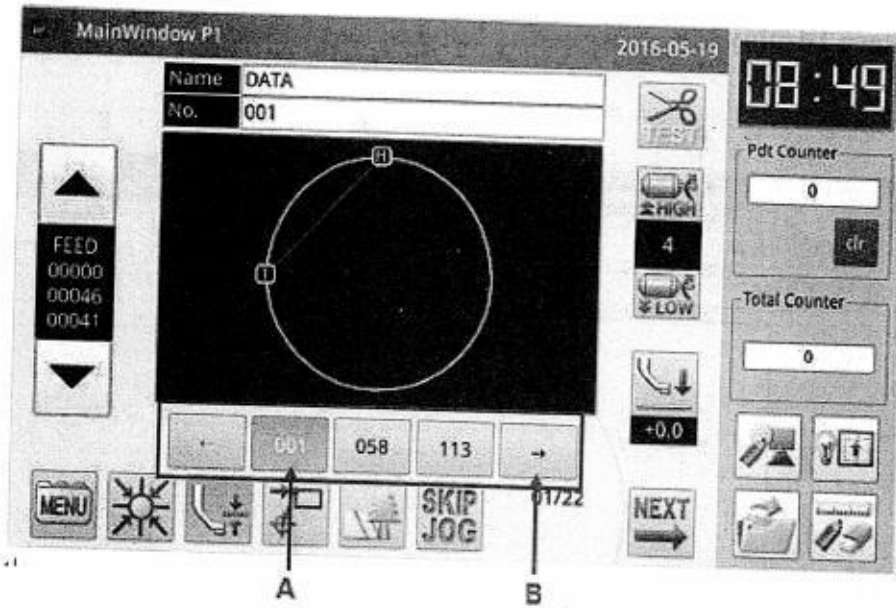

**Functions:**

No.	Description
A	Patten number hotkey (Current pattern: Displayed in white figure on blue background), select other number to shift the pattern.
B	Pattern number display and inquiry key

**Example:**

As shown in the above figure, 5 pattern numbers are in the hotkey list. The current pattern number is 600@NEW. If we select pattern No. 001@NEW, the current pattern will be shifted to pattern No. 001@NEW. The display is shown as below:

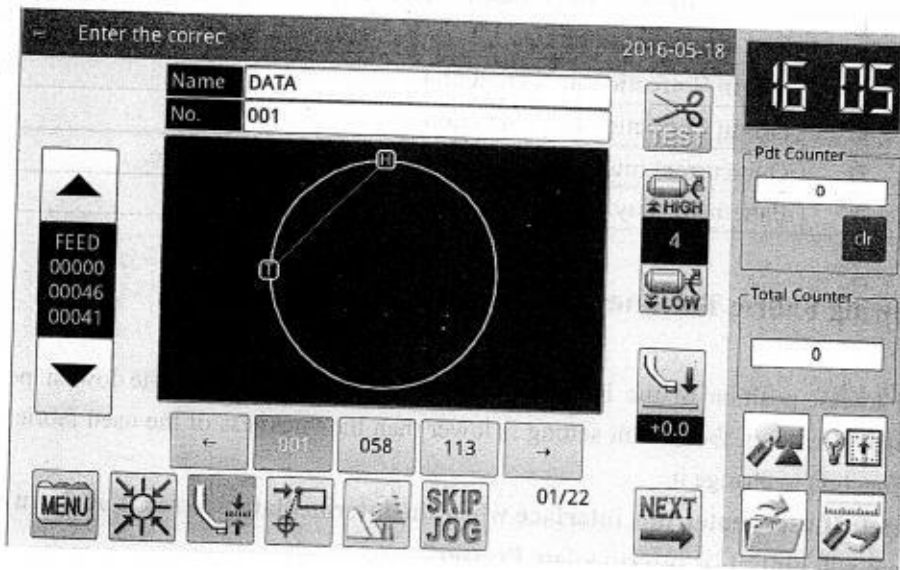

### 2.3.4 Pattern Display

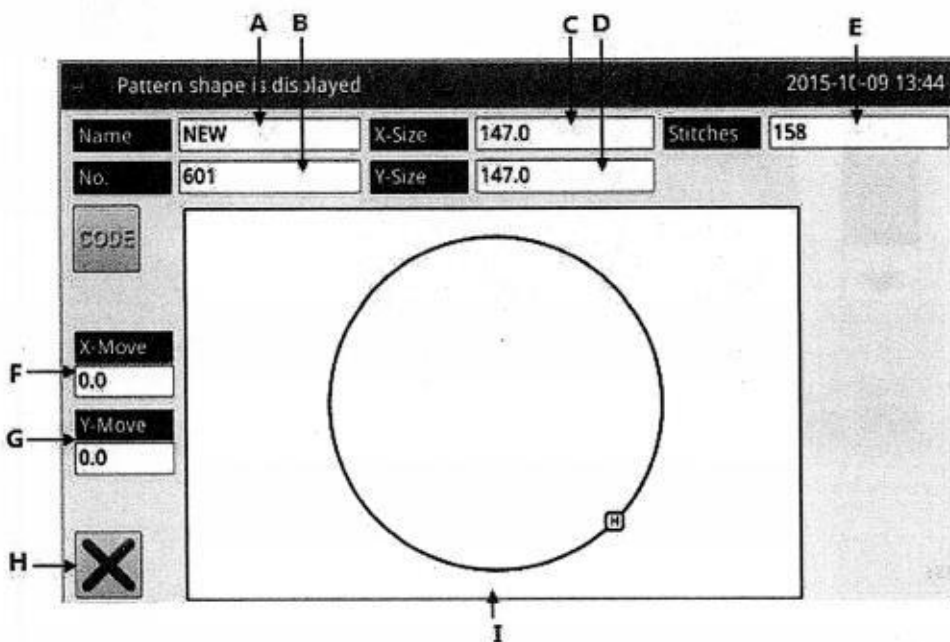

**Functions:**

No.	Description
A	Pattern Name
B	Pattern Number
C	Size of Pattern in X Direction
D	Size of Pattern in Y Direction
E	Display Total Stitch Number of Pattern (Including Feed, Trimming, End, Code and so on).
F	Origin Correction in X Direction
G	Origin Correction in Y Direction
H	Quit current interface and return to the previous interface.
I	Pattern Display.

### 2.3.5 Sewing Fabric Thickness Setting

The lowest position of the intermediate presser is changeable. If the lowest position of intermediate presser in the default setting is lower than the thickness of the used fabric, user can use this function to change it.



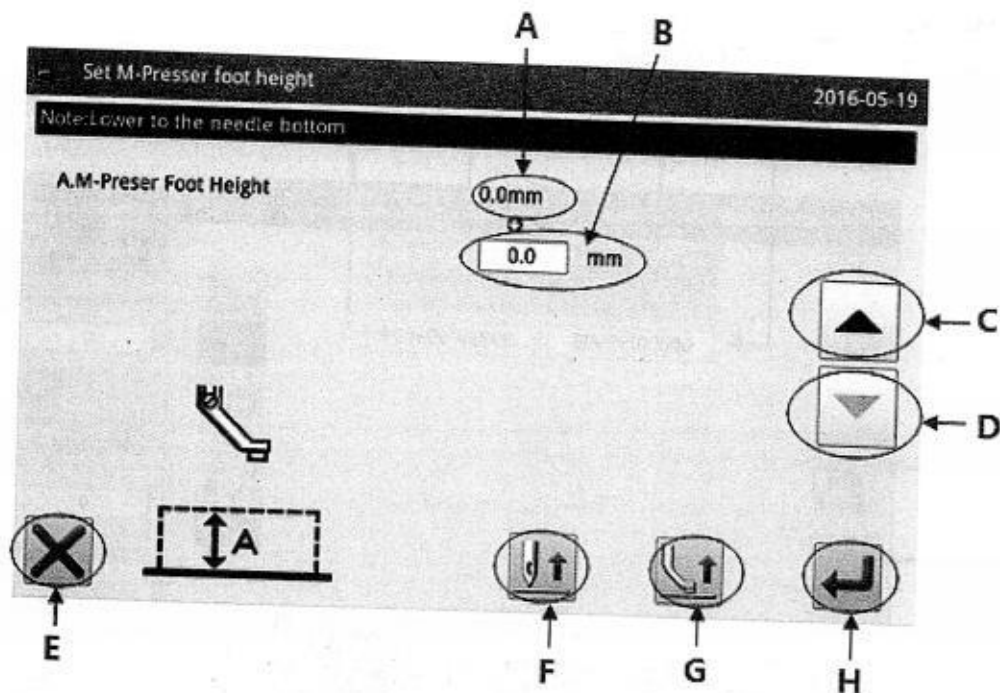

**[Note]:** If users enter this interface when the intermediate presser is at down position, the system will hint "Lift Intermediate Presser".

**[Note]:** After entering the interface for setting the fabric thickness: only when the intermediate presser goes down, can user set this parameter.

**[Note]:** The range of this parameter is 0.0~8.0mm.



**Functions:**





No.	Description
A	Current Height of Intermediate Presser
B	Target Height of Intermediate Presser
C	Increase Height The intermediate presser goes up by 0.2mm at each pressing
D	Decrease Height The intermediate presser goes down by 0.2mm at each pressing
E	Quit the current interface and return to the previous interface.
F	Move needle vertically.  : Needle down  : Needle up
G	Press it to move the intermediate presser in the arrow direction  : Intermediate presser up  : Intermediate presser down
H	Save and Quit

**2.4 Main Interface P2**

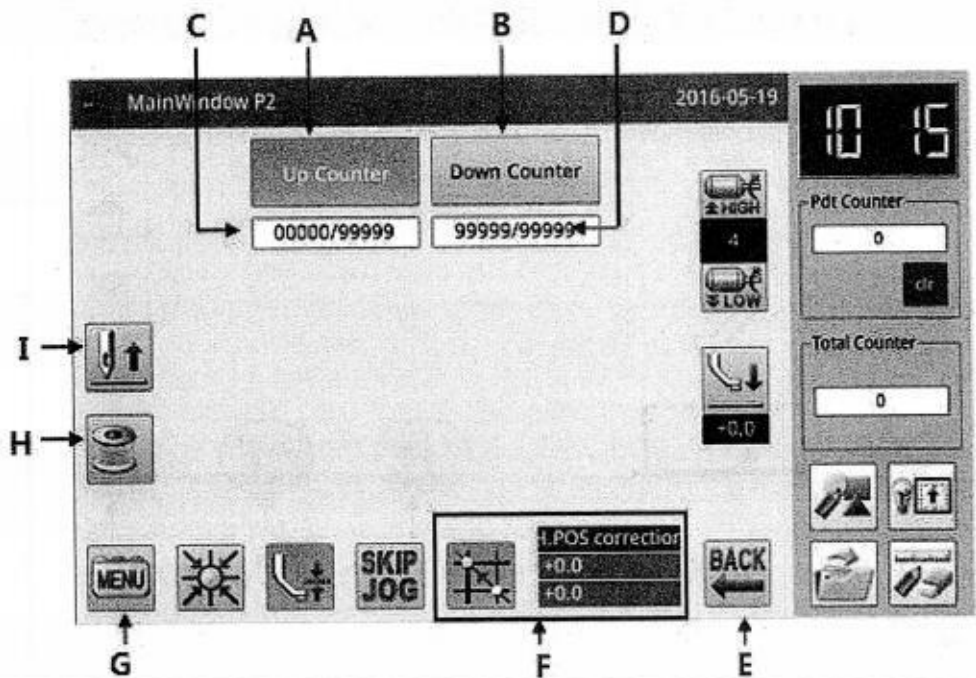
**Functions:**

No.	Functions	Content
-----	-----------	---------



A	Up Counter	Enter interface for setting up counter
B	Down Counter	Enter interface for setting down counter
C	Up Counter Value	Display the current value/ set value of up counter
D	Down Counter Value	Display the current value/ set value of down counter
E	Return	Press it to return to Main Interface P1
F	Origin Correction and Jump Stitches Setting	 : valid setting of origin  : invalid setting of origin  : set the number of jump stitches
G	MENU	Open the catalogue menu
H	Winding	Check the winding speed and time
I	Needle Lift	Move needle vertically.  : Needle up  : Needle down

### 2.4.1 Winding Mode

For winding, user has to activate this interface (Press  in main interface P2 and the intermediate presser will go down). Step the frame switch to lower the frame and then step the running switch to run the sewing machine at the set speed. But the X & Y axis will not move. When user releases the running switch, the sewing machine will stop at the upper stop position. **[Note]: The winding action is determined by the parameter “Winding” set in the Operation Setting Mode. (Please refer to [2.7.6 Parameter List])**

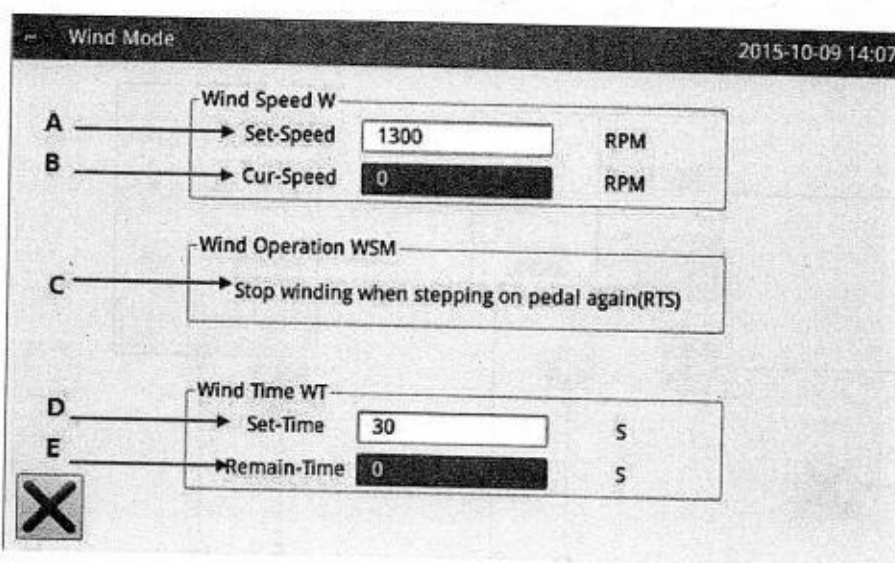

#### Functions:

No.	Description
A	Set Speed of Winding [Note]: Determined by Parameter “Winding” -> “Winding Speed Setting”
B	Actual Speed of Winding
C	Winding Operation Method [Note]: Determined by Parameter “Winding” -> “Winding Stop Method”.
D	Set Time of Timing Winding [Note]: Determined by Parameter “Winding” -> “Timing Stop of Winding”
E	If the operation method of winding is the timing winding, this place will display the time leftover.

### 2.4.2 Up Counter

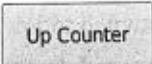
In main interface P2, press  to Enter the interface for setting the up counter.

[Note]: The counting method of the up/down counter is determined by the parameter “Counter” set in Operation Setting Mode (Please refer to [2.7.6 Parameter List]).

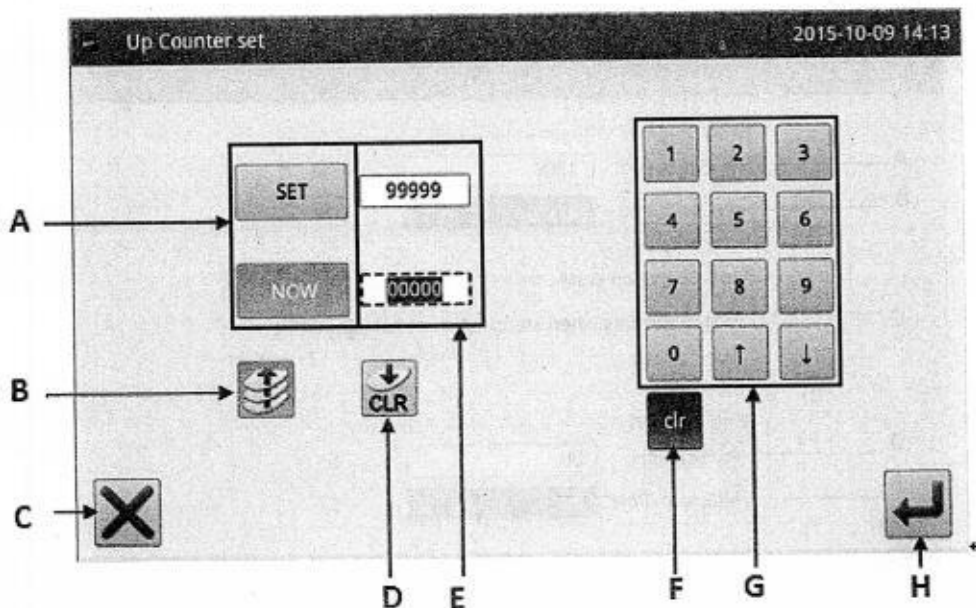

**Functions:**

No.	Content
A	Shift the input between the set value and the current value (The button in shadow is the selected one).
B	Up Counter Switch (This button will be effective when it is in blue background).
C	Quit counter setting mode and return to previous interface.
D	Clear current value.
E	Display the set value and current value (User can input the value in the dotted frame)
F	Clear the value inputted currently
G	Number keyboard, used to input set value and current value
H	Confirm the setting



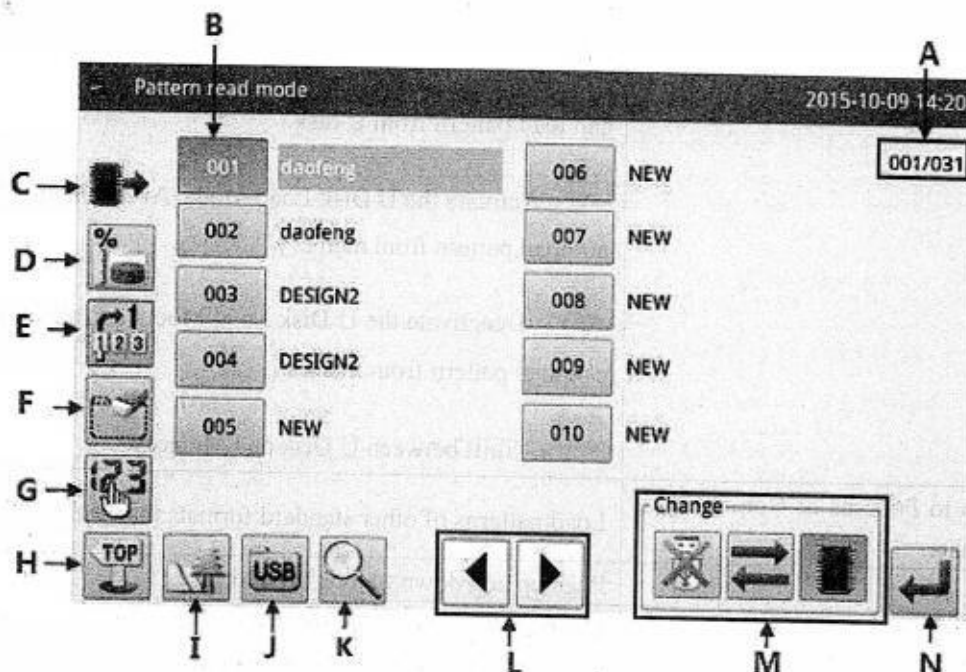

[Note]: The setting of the down counter is the same as that of the up counter, and the only difference is the icon indicating the effective status of the down counter ()

## 2.5 Load Pattern



### Functions:

No.	Functions	Content
A	Page	Display current page number/ total page number
B	Pattern List	Display the list of the saved pattern (Both number and name will be displayed). [Note 1]: If user selects pattern in VDT format, system will ask user to transform the pattern format. [Note 2]: If the stitch number of the selected pattern is over range or the data is damaged, the system will hint that the pattern is unable to be selected.
C	Memory / U Disk Object Display	: Memory Pattern List. : U Disk Pattern List [Note]: The default setting is to load pattern from memory
D	Free Memory	Display the total number of the patterns saved in memory
E	Direct Loading	Input the pattern number to load that pattern directly.
F	Delete Pattern	Delete the selected pattern. [Note]: The currently sewing pattern cannot be deleted.
G	Sequencing	Sequence the patterns according to their modification time or number.
H	Return to Main Interface	Return to main interface directly
I	Pattern Display	Same as this function key in main interface P1.
J	Select Memory/ U Disk	Load pattern from memory or U disk

		 : Activate the Memory Load Mode: At this moment, user cannot load pattern from U disk.  : Deactivate the Memory Load Mode: At this moment, user can load pattern from U disk.  : Activate the U Disk Load Mode: At this moment, user can not load pattern from memory.  : Deactivate the U Disk Load Mode: At this moment, user can load pattern from memory.  : Shift between U Disk and Memory
K	Jump to Patterns of Non-standard Formats	Load patterns of other standard formats than the nsp format
	Page	Page up and down to look up interface
L	Enter	Confirm the operation. After the operation, the sewing pattern will turn to the newly selected pattern.

**Operation Instructions:**

**Open the Interface to Load Pattern**

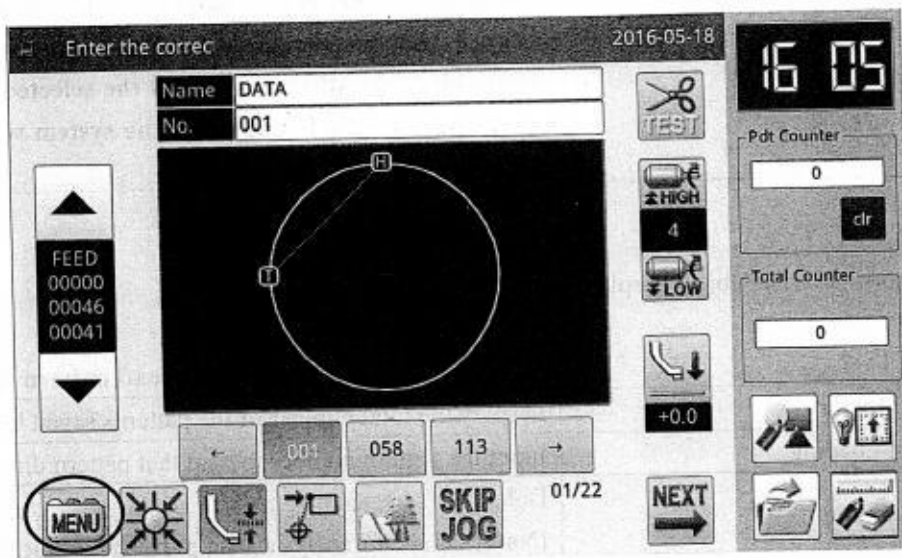

In main interface P1 (or P2), press  to activate the catalogue mode, and then press

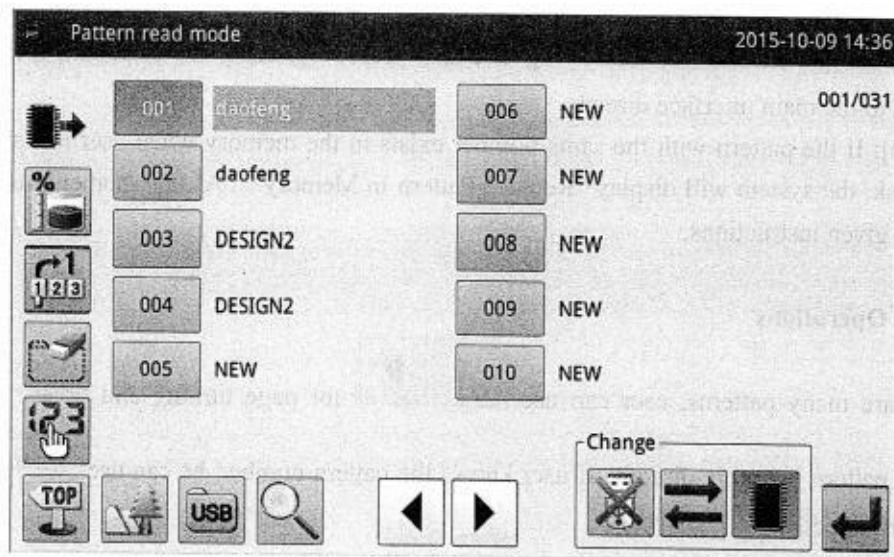

[Note]: If the moving frame is not at the origin, the system will be unable to load pattern. Therefore, please perform the operation for returning to origin first.

**2、 Select the Object for Loading (Memory/ U Disk)**



The default setting in this interface is the Memory Load Mode (you can see  at the upper left of the screen). You can press  to shift to U Disk Load Mode, which is shown at below:

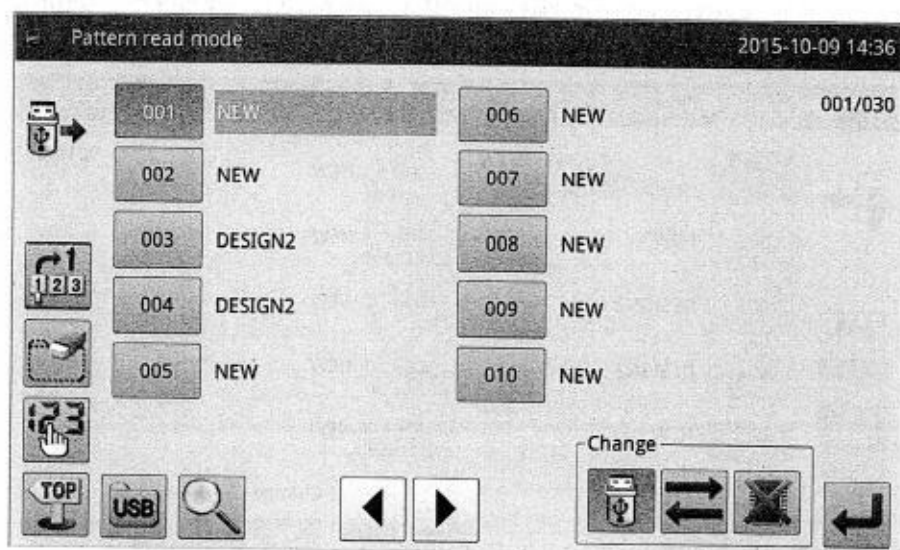

[Note]: If user performs the above operation without inserting the U disk, the system will display "U Disk Is Pulled Out".





[Note]: If user inserts the U disk in the current interface, the system will need 5 seconds to identify the U disk. After the identification, user can press  to enter the U Disk Load Mode. As long as the U disk is not pulled out, the system will not need to identify the U disk again when user enters the U Disk Load Mode again.

### 3、 Select and Confirm Pattern Number

Select the pattern number for sewing and then press . After the selection, the system will return to the main interface directly.

[Note]: If the pattern with the same number exists in the memory when user loads pattern from U disk, the system will display “Replace Pattern in Memory?”. At this moment, user need follow the given instructions.

#### 4、 Other Operations

If there are many patterns, user can use   for page turning and press  to view the pattern list more directly. If user knows the pattern number, he can use  to load the pattern directly.

### 2.5.1 Direct Load Mode

#### 1、 Select Direct Load Mode

Press  in pattern loading interface to enter the Direct Load Mode.

[Note]: To load pattern by directly inputting the pattern number is limited to the memory load mode.

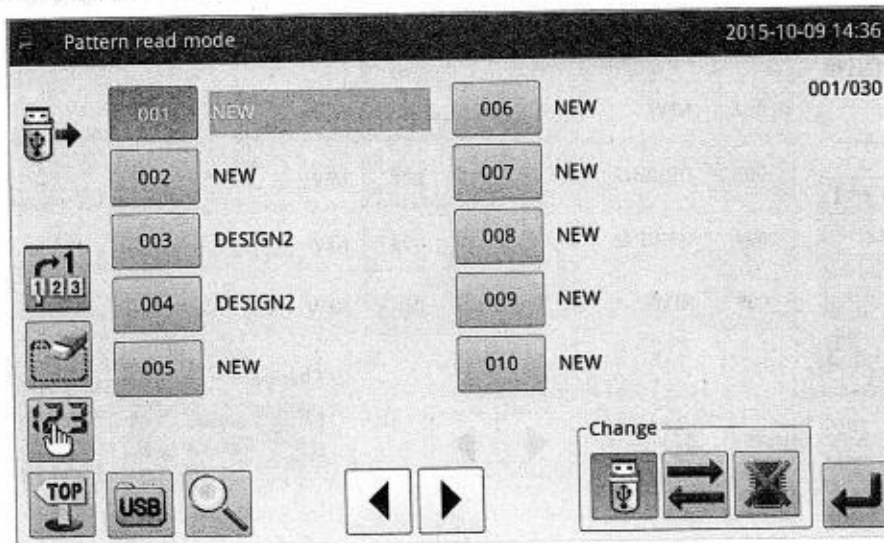



#### 2、 Input the First Number

(E.g. Load pattern No.012)

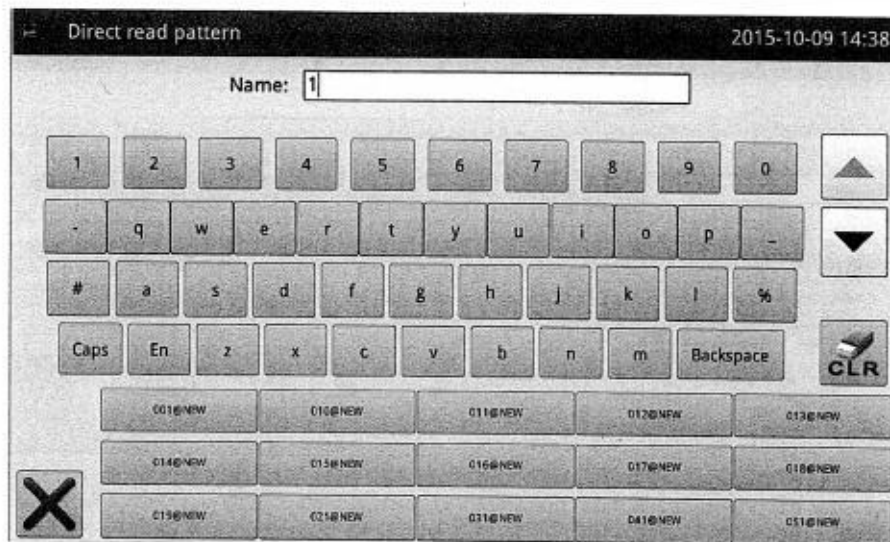
- ① Input “1”.
- ② The patterns saved in the memory whose first number is 1 will be displayed on the bottom keyboard as below:



### 3. Input the Second Number

- ① Then input "2".
- ② The patterns saved in the memory whose number begin with "12" will be displayed on the keyboard at the bottom of the interface.
- ③ Press  to clear the inputted number and re-input them.
- ④ At this moment, press  to activate the pattern and then the system will return to the main interface and display the selected pattern.

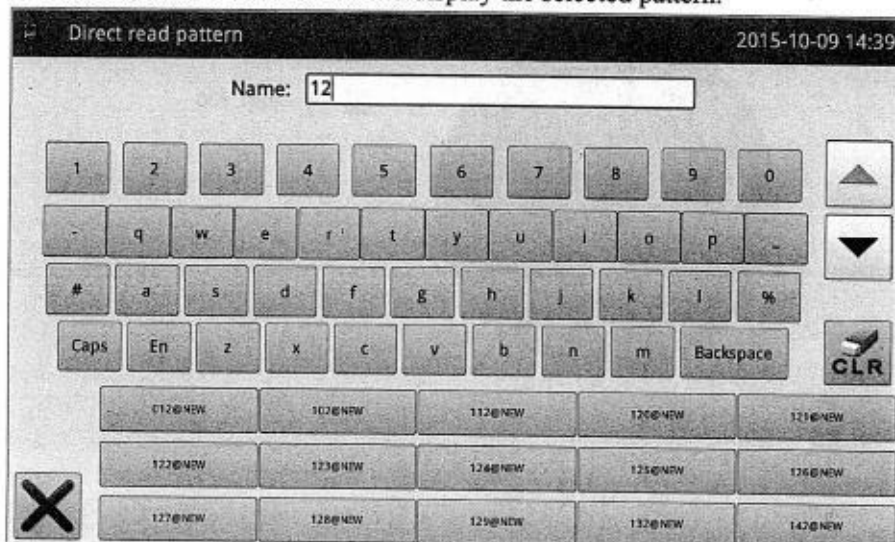

- ⑤ Shift to Chinese input method, and user can use Chinese to look up patterns.

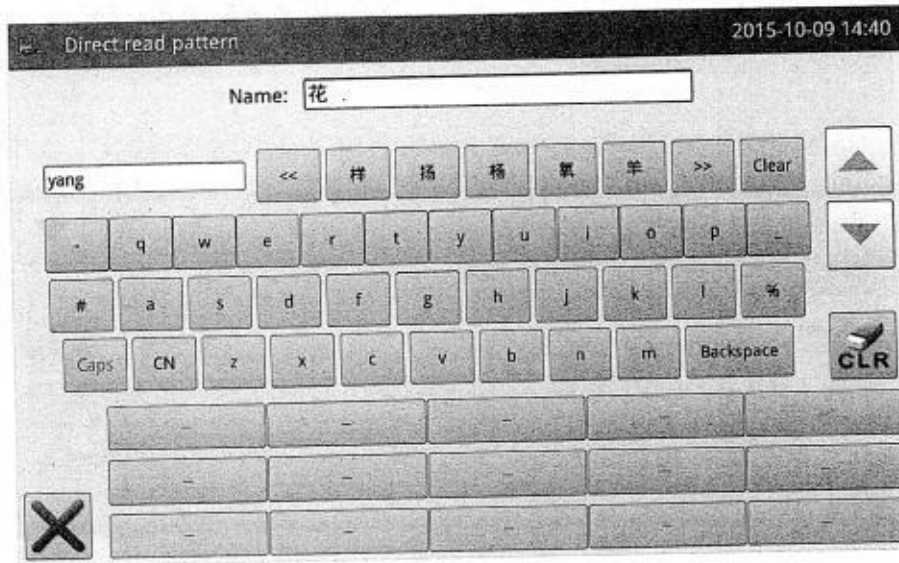

### 2.5.2 Free Memory

In the interface for loading pattern, user can press  to check the usage condition of the memory.

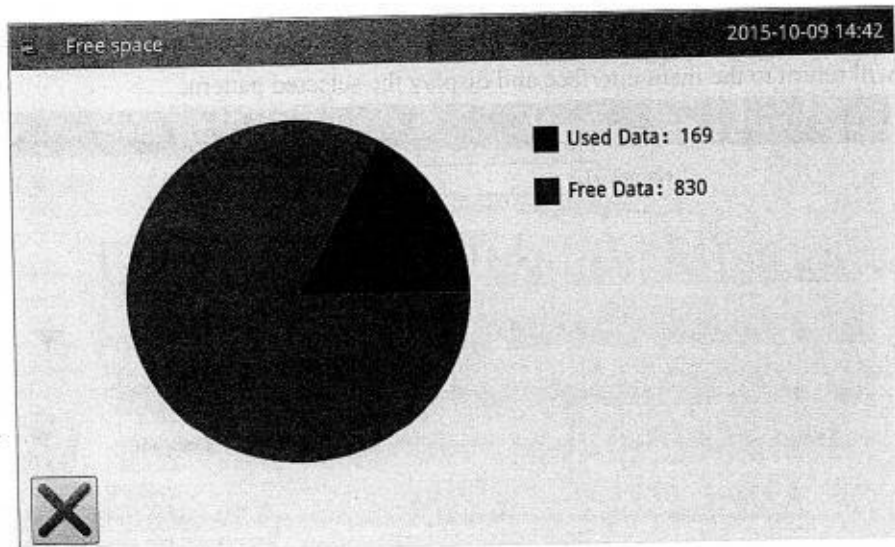

### 2.5.3 Delete Pattern

User can press  to delete a pattern. At this moment, the system will display “Delete Pattern from Memory?” (If the system is at U Disk Load Mode, the system will display “Delete the Selected File?”). User need follow the given instructions, but the pattern being sewn cannot be deleted.

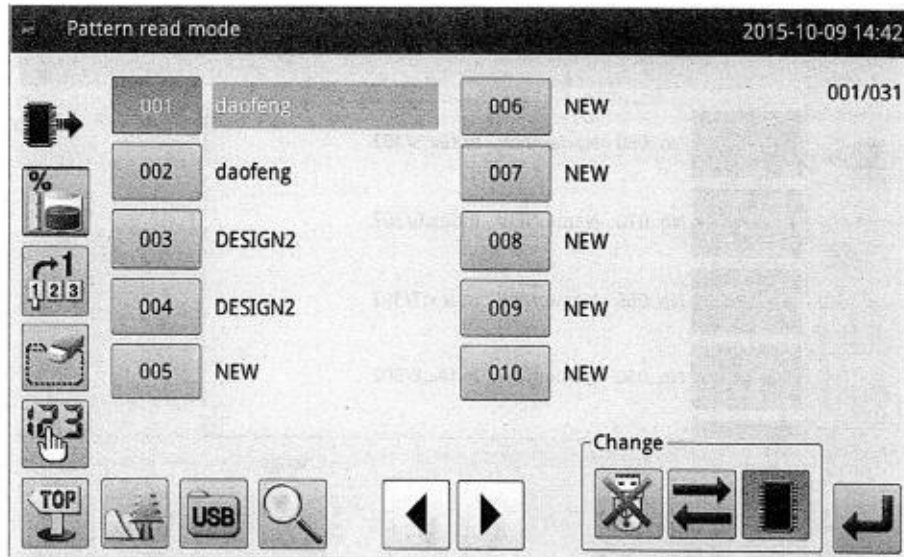

### 2.5.4 Supported Data Format

At present, the supported formats by the system are: NSP format, B format, BA format, VDT format, EMB format, DST format, DSB format, DSZ format, PLT format and DXF format.

### 2.5.5 Display Style of Pattern List

Press "LCD" -> "Display Style of Pattern Selection" to shift the display style of the pattern loading interface.

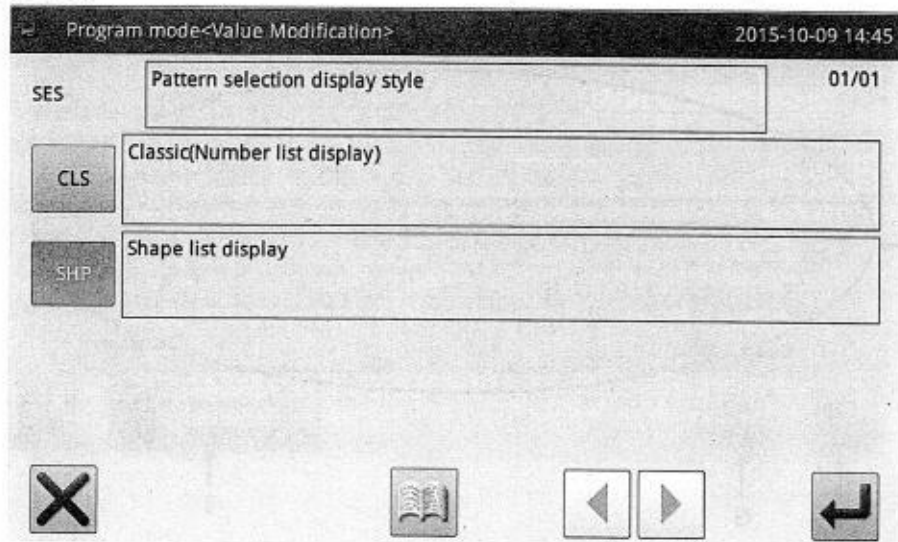

Set that parameter at "Display Pattern Shape" and return to the pattern load interface to view the patterns used.

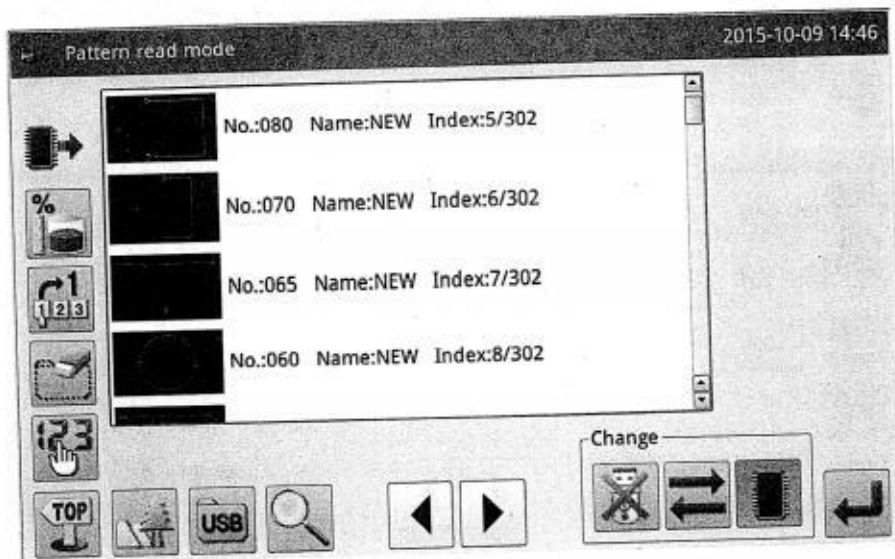

[Note]: Only can the used patterns be displayed in the pattern shape list.

[Note]: User can set it at "Function Setting" -> "Display Setting Mode".

### 2.6 Save Pattern

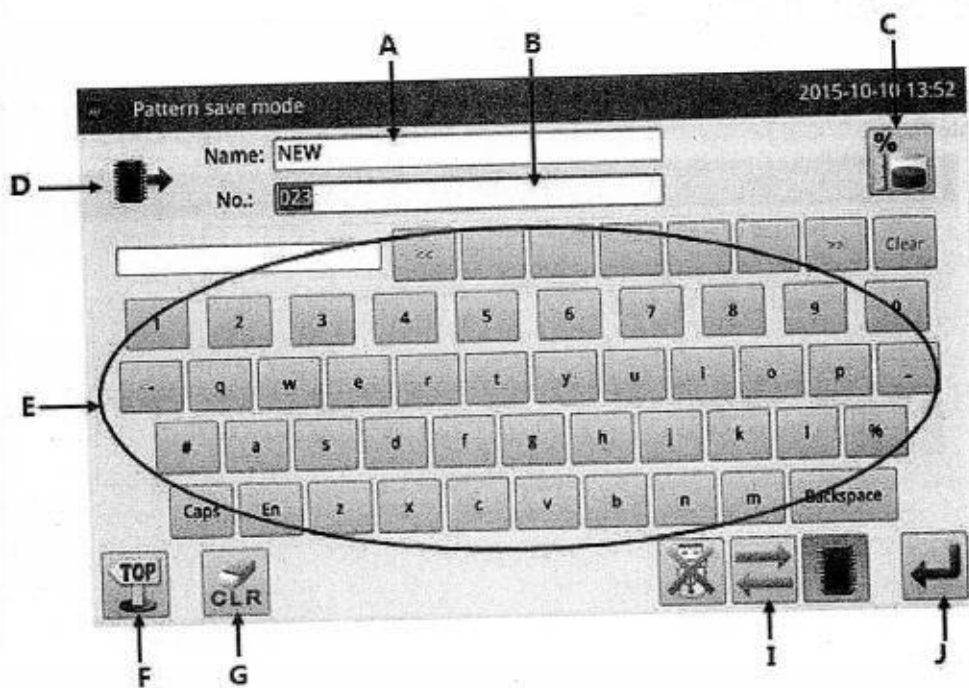

**Function:**

No.	Functions	Content
A	Input Pattern Name	Display the pattern name
B	Input Pattern Number	Display the pattern number
C, D, F, I	Same as Pattern Load Interface	Refer to the descriptions in Pattern Load Interface
E	Keyboard	Input name or number
H	Keep Pattern with Same Number	<input checked="" type="checkbox"/> 保留同号花样 : select to keep the pattern with the same number <input type="checkbox"/> 保留同号花样 : not to keep the pattern with the same number
G	Clear All Characters	Press it to clear all the inputted characters

**Operation Instructions:****1、Enter Pattern Load Interface**



In main interface P1 (or P2), press  to activate the catalogue mode, and then press



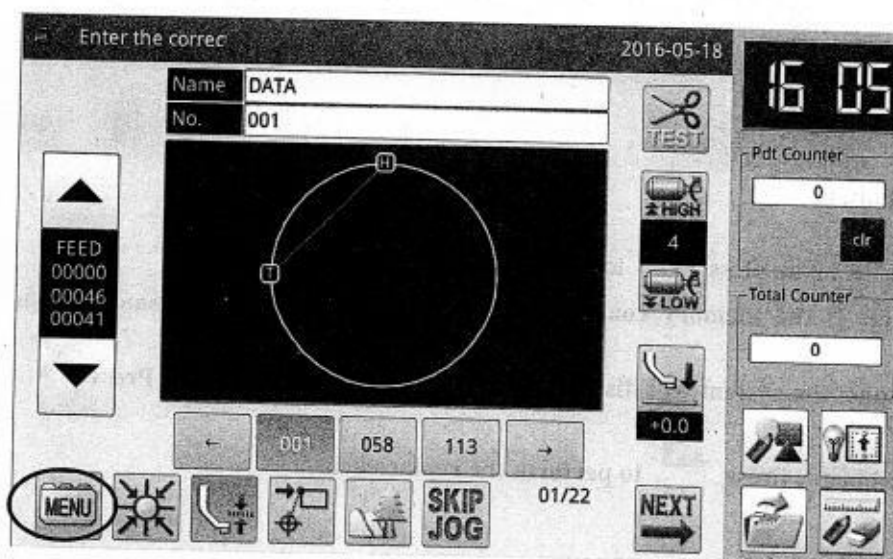

[Note]: If the moving frame is not at the origin, the system will be unable to save pattern. Therefore, please perform the operation for returning to origin first.



## 2、 Set Name and Number

The default setting in this interface is the Memory Save Mode (you can see  at the upper left of the screen). You can press  to shift to U Disk Save Mode.

Press  or  to input the name or number.

Pressing  is to delete the first character at the left of the cursor, while pressing  is to clear all the characters.

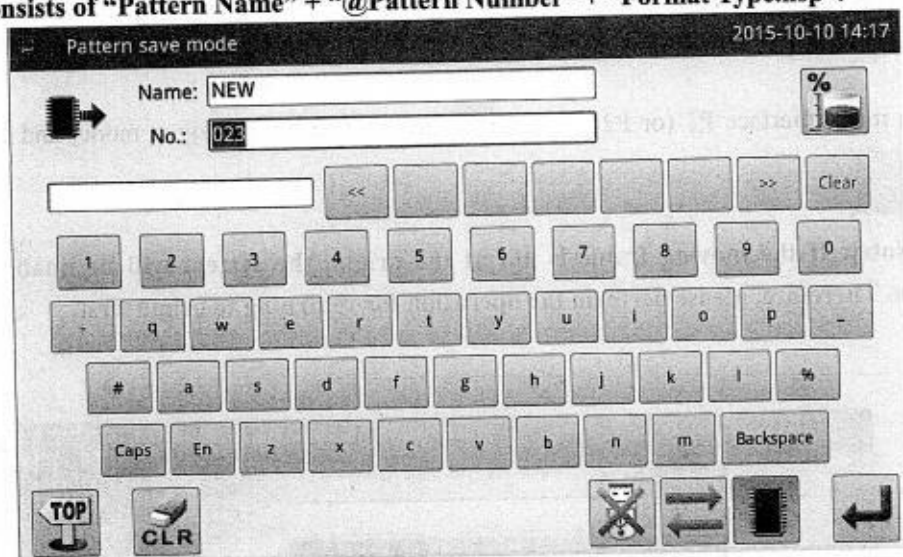

If user need shift between capital and small letters, please press .

[Note]: User can decide the number for a pattern before saving; the filename of a pattern consists of "Pattern Name" + "@Pattern Number" + "Format Type.nsp".



## 3、 Save Pattern

After the input, press  to return to the main interface directly

[Note]: If the memory contains the pattern with the number same to that of the inputted one, the system will display "Replace Pattern in Memory?" Press  to cancel the replacement; press  to perform the replacement.

## 2.7 Operation Setting

It is to set each parameter. For the description of each parameter, please refer to [2.7.6 Parameter List].

### 2.7.1 Setting Method

#### 1、 Enter Operation Setting:

In main interface P1 (or P2), press



to activate the catalogue mode,

and then press **Program**

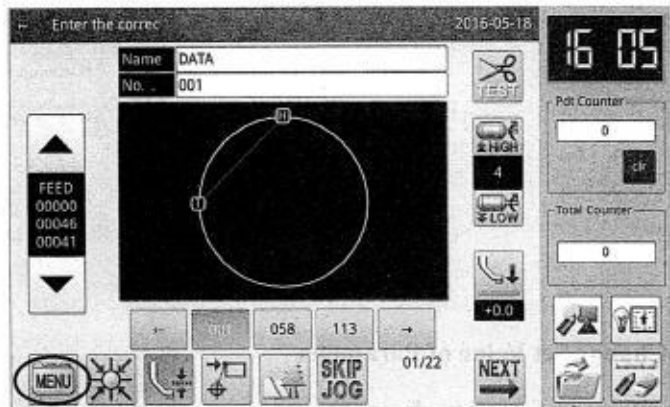

#### 2、 Interfaces at Setting Mode

After entering the operation setting interface, user can use



to turn the pages for selecting parameters.



#### 3、 Example :

##### ① Mode Selection

Select the parameter for setting to activate the “Internal Parameter Setting Interface”. Here, we press “Frame”



② Internal Parameter Setting Interface

Select the parameter for setting to activate the “interface for changing the set value”. (We press “POP” here.)

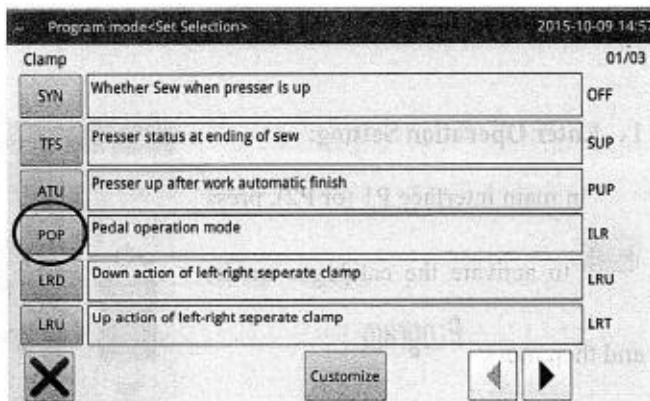

③ Change Set Value of Parameter

Press parameter to change the set value (here, we press “ILR”). Then, press to confirm it.

[Note]: Pressing is to display the descriptions of that parameter and its value.

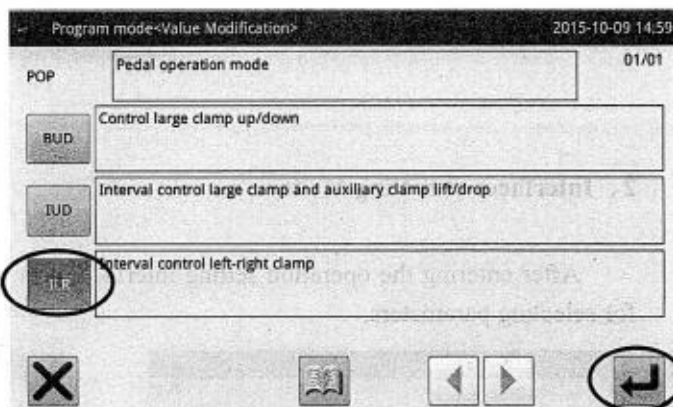

④ Check the Changed Parameter Set Value

Return to the “Internal Parameter Setting Interface”, where user can check the set value after change. Press to quit.

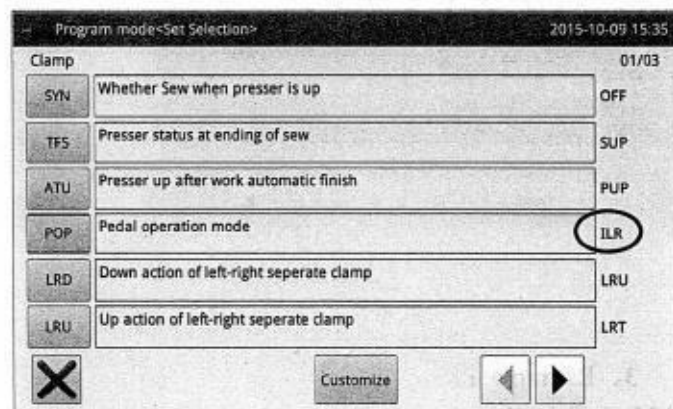

⑤ Return to Mode Selection Interface

Return to “Mode Selection” interface. Because the set value is changed, the button “Modified” is displayed.

For returning to main interface P1 (or

P2), please press .

For checking the modified content, please press the “Modified” key.

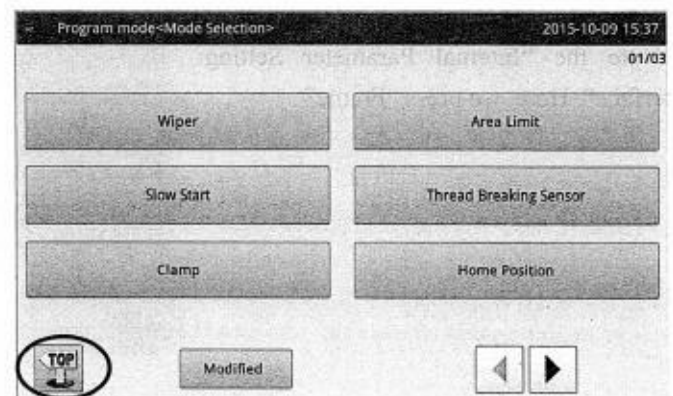

⑦ Check the Content of the Modified Parameter

a) Enter Password Input Mode

Pressing “Modified” in the “Mode Selection” interface will activate the Password Input Mode, where user can enter the Modified Parameter Setting Mode with the correct password. (For setting the password, please refer to [2.7.3 Parameter Encryption].)



b) Enter Modified Parameter Setting Mode

In this interface, the modified content of the parameter will be displayed. User can modify it again in this interface (Here, press “POP”).

If user wants to restore the modified parameters, he should press the button with the name of that parameter (Here, he can press “Pedal Operation Method”, “Intermediate Presser Down Synchronization”) and then click “Restore”. After that user only needs to follow the instruction of the system.

If user wants to restore the entire setting to their default values, he can press “Restore All”. After that user only needs to follow the instruction of the system.

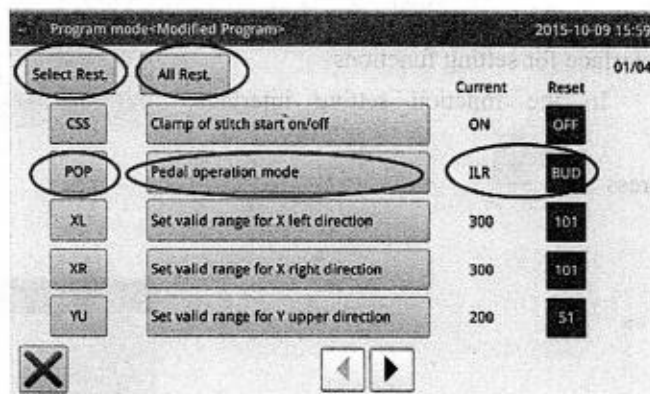

2.7.2 Types of Parameter Setting

There are two ways for setting parameter: selection type and input type, as shown below:

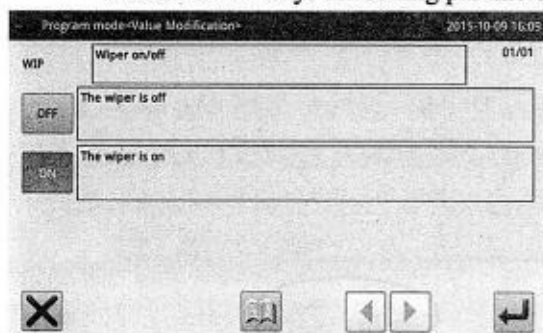

Selection Type

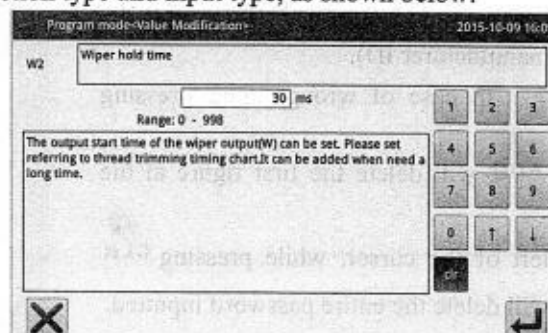



Input Type

### 2.7.3 Parameter Encryption

In the parameter mode, each operation entrance can be attached a password, so as to avoid the mistake operation.

#### 1、Enter Parameter Encryption Interface:

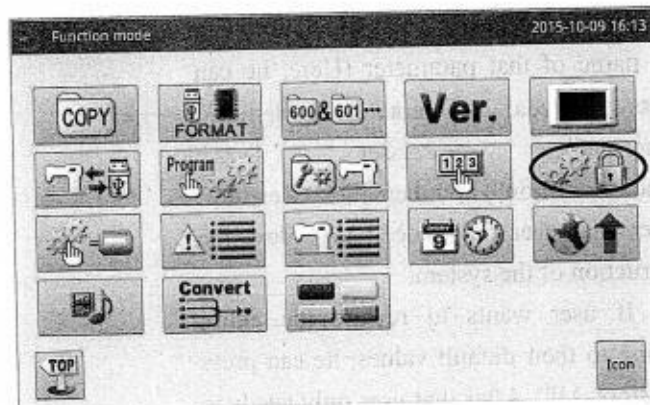
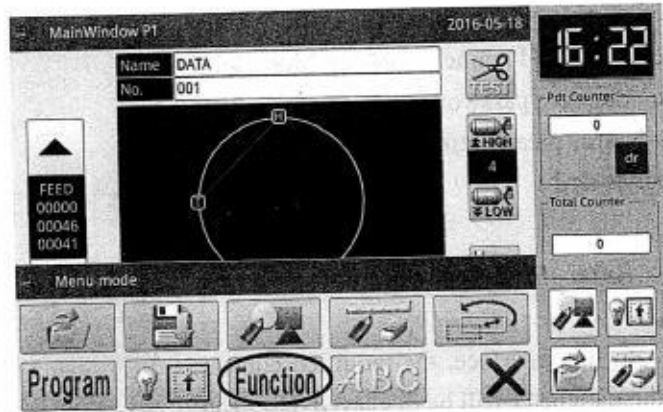

In main interface P1 (or P2), press  to activate the catalogue mode, and then press **Function** to Enter the interface for setting functions.

In the function setting interface, press .



#### 2、Input Password:

Before entering the Parameter Encryption Mode, user need input password. (The original password is the manufacturer ID).

In case of wrong input, pressing  will delete the first figure at the left of the cursor, while pressing  will delete the entire password inputted.

Input the password and press .

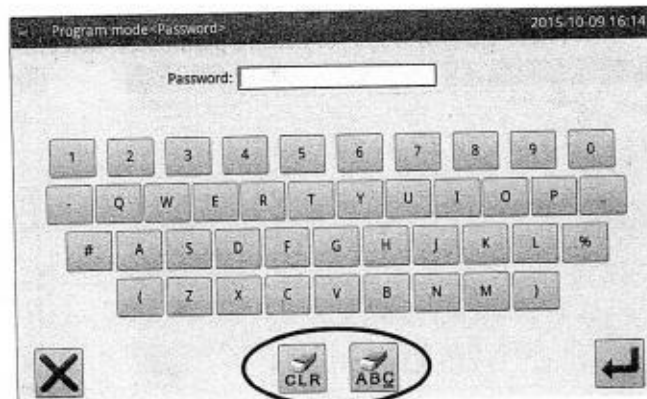

## 2、 Select Parameter for Encryption:

As shown in the picture, user can select one or many parameters for encryption. (Here, we select "Pause".)

暂停: Selected

暂停: Unselected

After selecting the parameter for

encryption, user can press .

From then on, user has to input password when setting the parameter that was encrypted.

For changing password, please press .

## 3、 Change Password

In the interface of setting new password,

press  当前密码:

新密码:  &

确认密码:  in

order and input the current password, new password, new password confirmation respectively. At last press



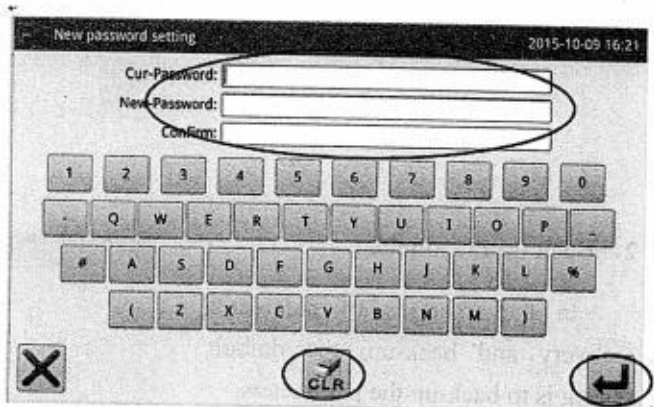
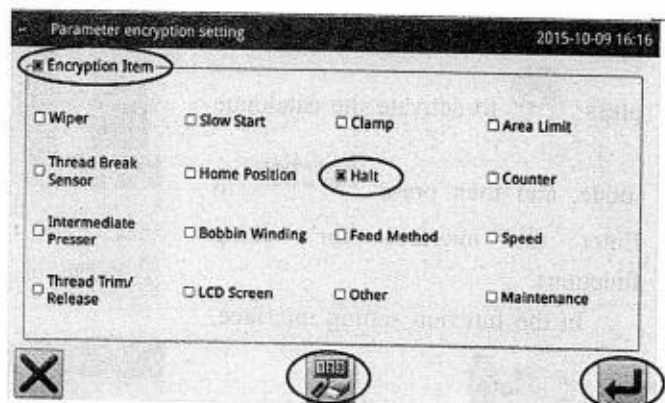

**[Note]: The original password is the manufacturer ID. After setting the password, the current password is the password set last time.**



### 2.7.4 Recovery and Back-up of Parameters

User can save the changed parameter into U disk for the recovery operation in future.

### 1、Enter Interface of Parameter Recovery and Back-up:

In main interface P1 (or P2), press  to activate the catalogue mode, and then press  to Enter the interface for setting functions.

In the function setting interface, press .

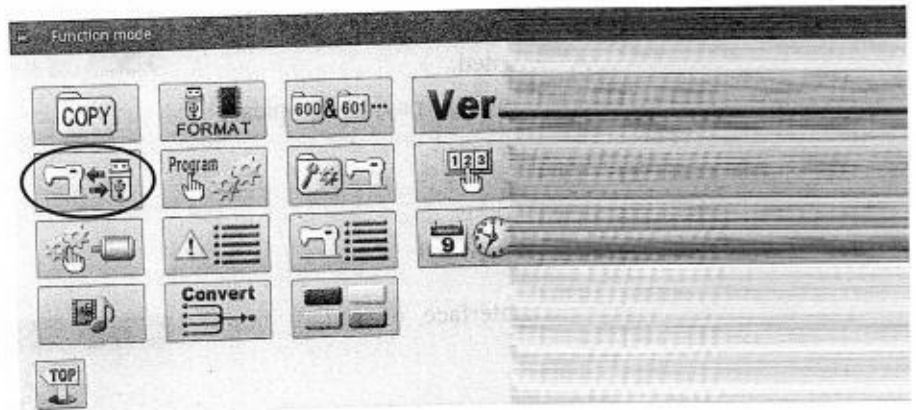
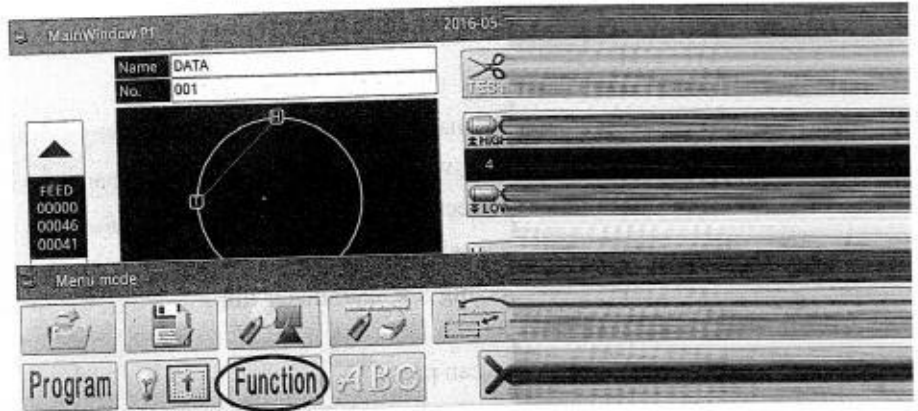

### 2、Back up Parameters

In the interface of parameter recovery and back-up, the default setting is to back-up the parameters.

After inserting the U disk, press . After the operation, the system will create a catalogue named "bakParam" in U disk automatically. The file "backup.param" within that catalogue is the parameter back-up file.

**[Note]: the file with the same name will be replaced with new data. The original data will be lost.**

In parameter recovery operation, user can press  to shift to recovery mode.

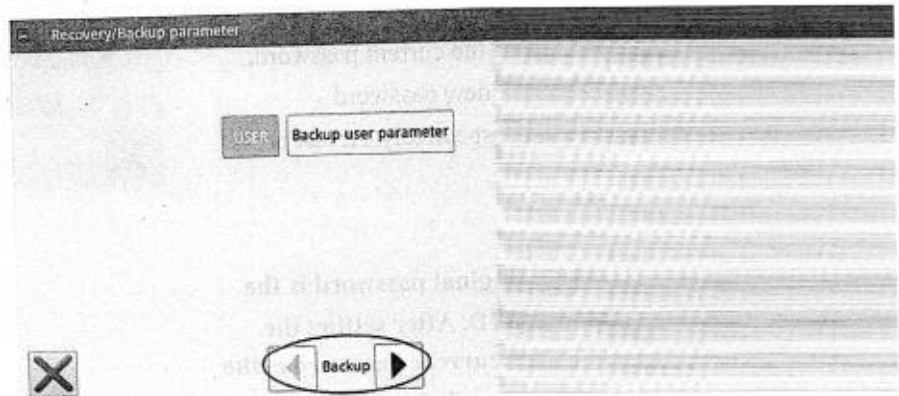

### 3、 Parameter Recovery

At recovery mode, press  to recover the parameters. After the operation, the system will return to the previous level.

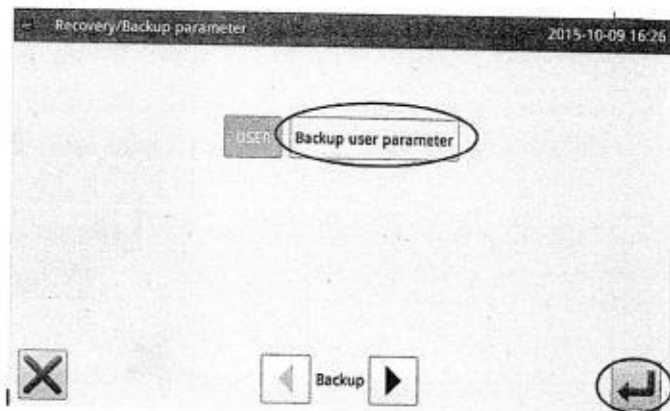



### 2.7.5 Default Parameter Recovery

User can restore the parameters to their default values. Additionally, user can also save the set parameters for the usage in future.

#### 1、 Enter Default Parameter Recovery:

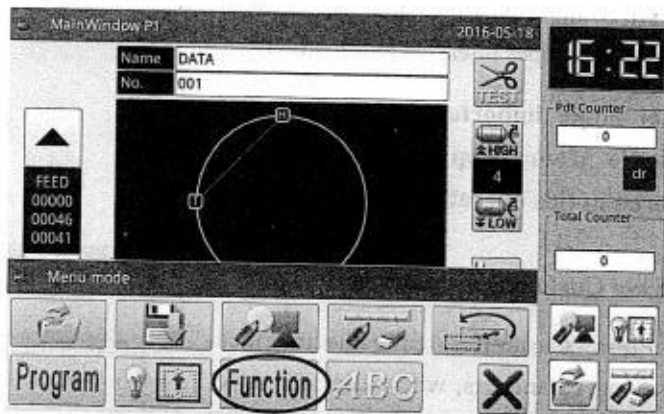
In main interface P1 (or P2), press  to activate the catalogue mode, and then press **Function** to enter the interface for setting functions.



In Function Setting Interface, press  and then input the password (the original password is the manufacturer ID). With the correct password, user can enter Default Parameter Mode

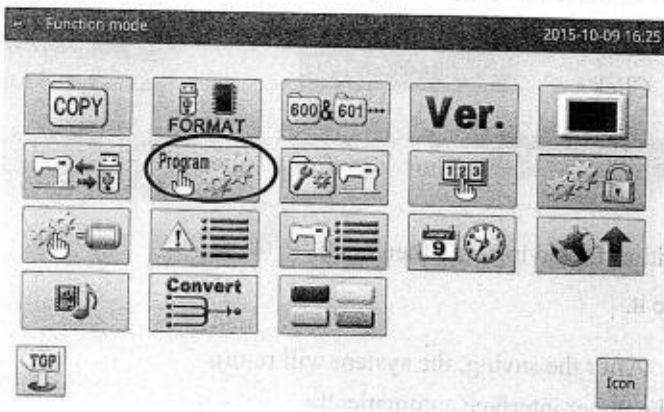

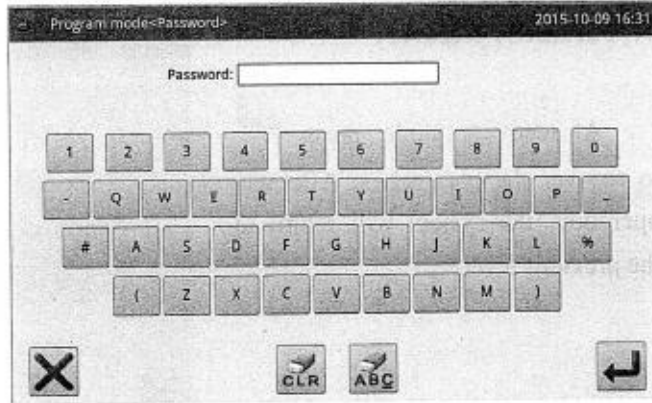

**2、 Use the Default Parameter**

Click the corresponding default parameter and then press “System Default” to reload that value

After the reloading, the system will return to the upper interface automatically.

**[Note]** Some important parameter, like “Spindle Motor Stop Angle” cannot be restored in this operation.

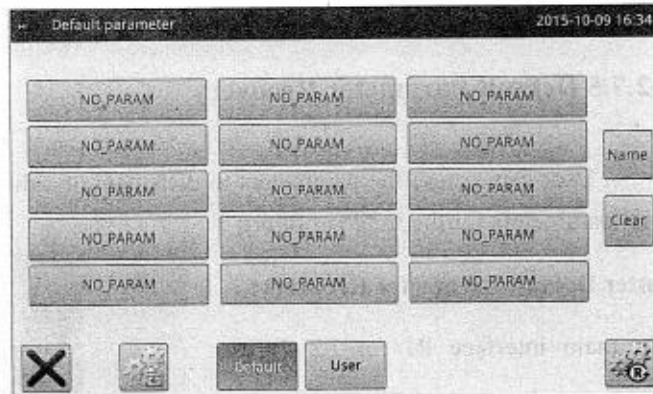

**3、 Save Customized Parameter**

Press “Custom” to enter the interface for saving parameters, where user can save the parameter set value.

Click



to confirm the

position for saving, and then click  to save it.

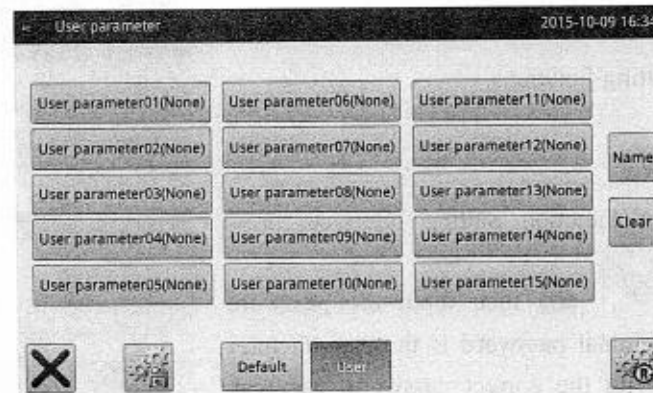

After the saving, the system will return to the upper interface automatically

**[Note]** The parameter for repair and maintenance cannot be saved.

**[Note]** The motor installation angle and motor parameters can be saved.

**4、 Load Parameter Saved by User**

Enter the Customized Parameter interface. Check the content on button “Customized Parameter xx (Y/N)”. If it is Y in the bracket, it means there is saved customized parameter.

Click that key and press  to reload the corresponding parameter. After the operation, the system will return to the upper interface automatically.

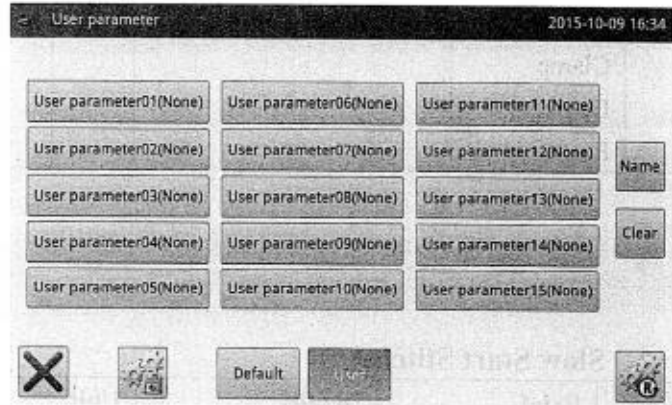

**2.7.6 Parameter List**

**1、 Thread Adjuster:**

Code	Brief	Details	Unit	Step Length	Range	Default Value	Type
WIP	Thread Adjuster Switch	Thread adjuster (W) switch			0:OF:Thread Adjuster off 1:ON:Thread Adjuster on	1	Selection
W1	Thread Adjuster Start Time	Set the start time of thread adjuster (W) according to the thread-trimming order. Usually, there is no need for change.	ms	2	0~998	30	Input
W2	Thread Adjuster Work Time	Set the working time of thread adjuster (W) according to the thread-trimming order. User can prolong the time if necessary.	ms	2	0~998	30	Input
W3	Thread Adjuster Stop Delay	The delay time for the device return after the action of thread adjuster (W)	ms	1	0~255	0	Input
CSS	Needle Thread Clamp Device	Needle thread clamp device switch			OFF ON	OFF	Selection
CRS	Needle	Needle thread clamp			0~16	8	Input

Thread Clamp Device Power-on	device power-on					
------------------------------	-----------------	--	--	--	--	--

## 2、 Slow Start Stitch:

Code	Brief	Details	Unit	Step Length	Range	Default Value	Type
ST1	Start Speed of 1 <sup>st</sup> Stitch	Start Speed of 1 <sup>st</sup> Stitch	100RPM	1	2~27	3	Input
ST2	Start Speed of 2 <sup>nd</sup> Stitch	Start Speed of 2 <sup>nd</sup> Stitch	100RPM	1	2~27	5	Input
ST3	Start Speed of 3 <sup>rd</sup> Stitch	Start Speed of 3 <sup>rd</sup> Stitch	100RPM	1	2~27	10	Input
ST4	Start Speed of 4 <sup>th</sup> Stitch	Start Speed of 4 <sup>th</sup> Stitch	100RPM	1	2~27	15	Input
ST5	Start Speed of 5 <sup>th</sup> Stitch	Start Speed of 5 <sup>th</sup> Stitch	100RPM	1	2~27	20	Input

## 3、 Frame:

Code	Brief	Details	Unit	Step Length	Range	Default Value	Type
SYN	Sewing When Frame Is Up	Can the machine perform sewing when the board is up			0:OF: No 1:ON:Yes	0	Selection
TFS	Frame Status at Sewing End	Frame Status at Sewing End			0:SUP: Back to start point and go up 1:SLU: Go up at sewing end. 2:SBU: Back to start point. It goes up when user steps pedal.	0	Selection
ATU	Frame Auto Up after Work	After working, the Frame goes up automatically.			0:PUP:Auto UP 1:NUP:Not Auto Up	0	Selection

POP	Pedal Operation Method	Pedal Operation Method			0:BUD:Frame Up/Down 1:IUD: Indirect Control of Frame & Help Frame Up/Down 2:ILR: Indirect Control of L/R Frame	0	Selection
LRD	Lower Action of L/R Separate Frames	Lowering action of left presser and right presser			0:LRU:Down at Same Time 1:LRN:Left Then Right 2:RLD:Right Then Left	0	Selection
LRU	Lift Action of L/R Separate Frames	Lifting action of left frame and right frame			0:LRT: Up after work 1:LTD:Left Frame Down after Work 2:RTD: Right Frame Down after Work	0	Selection
DYN	Special Presser	Support Reverse & Stretch Pressers 3- None 4- Reverse Presser 5- Stretch Presser		1	0-255	0	Input
PSS	Presser Status at Stop	Presser Status at Stop			0:UP:Presser Down 1:DN:Presser Up	0	Selection
OPT							
2PE							
THG							
OPR							
OPC							
POD							
ASD							
DSD							

**4、 Range Limitation:**

Code	Brief	Details	Unit	Step	Range	Default	Type
------	-------	---------	------	------	-------	---------	------

				Length		Value		
ALC	Cancel Range Protection	Cancel Range Protection				0:OF:Protection Off 1:ON:Protection On	1	Selection
XL	Set Effective Range in Left X Direction	Set effective range in left X direction	mm	1		2~255	101	Input
XR	Set Effective Range in Right X Direction	Set effective range in right X direction	mm	1		2~255	101	Input
YU	Set Effective Range in Up Y Direction	Set effective range in up Y direction	mm	1		2~255	51	Input
YD	Set Effective Range in Down Y Direction	Set effective range in down Y direction	mm	1		2~255	51	Input

### 5、 Thread-breakage Detector:

Code	Brief	Details	Unit	Step Length	Range	Default Value	Type	
PRT	Thread-breakage Detection	Thread-breakage Detection				0:OF: OFF 1:ON:ON	0	Selection
ISD	Invalid Stitches at Sewing Start for Thread-breakage Detection	Invalid Stitches at Sewing Start for Thread-breakage Detection		1		0~15	8	Input
IND	Invalid Stitches during Sewing for Thread-breakage Detection	Invalid Stitches during Sewing for Thread-breakage Detection		1		0~15	3	Input
TRM	Trim at Thread-breakage Detection	Trim at Thread-breakage Detection				0:ON: Trim at Thread-breakage 1:OF: Not Trim at Thread-breakage	0	Selection

### 6、 Origin Position:

Code	Brief	Details	Unit	Step Length	Range	Default Value	Type	
PTR	Return to Origin at Power-on	Return to origin at power-on				0:OF:Not Return 1:ON:Return	0	Selection

PRF	Forbid Returning to Origin at Presser Up	Forbid returning to origin at presser up			0:OF:Permitted 1:ON:Forbidden	0	Selection
DOG	Search Origin at Sewing End	Search origin at sewing end			0:OFF:Not Search Origin, Stop at End Point 1:ON:Search Origin (Sub-origin) 2:RET:Return to Sewing Start	1	Selection
RST	Set Sewing Start Resetting Path	Set sewing start resetting path			0:LIN:Linear Return to Sewing Start 1:PAT:Return to Origin along Pattern 2:ORG:Search Origin Then Return to Sewing Start	0	Selection
DED	Select Highest Position at Searching Origin	Whether to select highest position at searching origin			0:OF:Not Select 1:ON:Select	0	Selection
OPA	Origin Presser Action	Origin presser action			0:DNW:Presser Down 1:UP:Presser UP	1	Selection
NRM	Search/Return to Origin Path	Path selection of searching/returning to origin			0:NRM: Standard 1:REV: Reverse 2:YTX:Y to X 3:XTY:X to Y	0	Selection
REV	Search/Return to Origin Path at Reverses	Path selection of searching/returning to origin at reverse			0:NRM: Standard 1:REV: Reverse 2:YTX:Y to X 3:XTY:X to Y	0	Selection
XSP	X Axis Sensor Position	X axis sensor is at the left or right side of the head			0:L:Left 1:R:Right	0	Selection

**7. Pause :**

Code	Brief	Details	Unit	Step Length	Range	Default Value	Type
------	-------	---------	------	-------------	-------	---------------	------

POS	Needle Position at Pause	Needle position at pause			0:DWN:Needle Down 1:UP:Needle Up	1	Selection
ACT	Presser Action at Pause	Presser action at pause			0:DWN:Presser Down 1:UP: Presser Up	0	Selection
TYP	Pause Switch Type	Pause switch type			0:AUT:Auto Lock 1:NRM:Normal	0	Selection
TRM	Auto Trimming at Pause	Auto trimming at pause			0:AUT:Auto 1:OFF:No trim	0	Selection
SYP	Security Switch Type	Security switch type			NCT: always off NOT: always on	NCT	Selection

**8、Counter:**

Code	Brief	Details	Unit	Step Length	Range	Default Value	Type
UCM	Up Counter Mode	Up counter mode			0:OFF:Up Counter Off 1:PAT:Count by Pattern 2:CYC:Count by Cycle	1	Selection
DCM	Down Counter Mode	Down counter mode			0:OFF:Down Counter Off 1:PAT:Count by Pattern 2:CYC:Count by Cycle	1	Selection
URV	Reserve Up Counter Value at Inputting Pattern	Reserve up counter value at inputting pattern			0:CLR:Clear 1:RSV:Reserve	1	Selection
DRV	Reserve Down Counter Value at Inputting Pattern	Reserve down counter value at inputting pattern			0:CLR:Clear 1:RSV:Reserve	1	Selection
POC	Clear Counter at Repowering	Clear counter value at repowering			0:CLR:Clear 1:RSV:Reserve	1	Selection
NUP	Cannot Change Up Counter (UP)	Cannot change up counter (UP)			0:OF: Permitted 1:ON:Forbidden	0	Selection
NDP	Cannot Change Down Counter (DN)	Cannot change down counter (DN)			0:OF: Permitted 1:ON: Forbidden	0	Selection
UTO	Sewing	Sewing			0:OF:Stop Sewing	0	Selection

	Machine Action at Reaching Up Counter (UP) Set Value	machine action at reaching up counter (up) set value			1:ON:Continue Sewing		
DTO	Sewing Machine Action at Reaching Down Counter (DN) Set Value	Sewing machine action at reaching down counter (DN) set value			0:OF:Stop Sewing 1:ON:Continue Sewing	0	Selection
NPC	No Change of Production Amount	No change of production amount			OFF: Change Permitted ON: Change Forbidden	ON	Selection

### 9、Intermediate Presser:

Code	Brief	Details	Unit	Step Length	Range	Default Value	Type
SYN	Down Synchronization	Synchronization of lowering intermediate presser			0:BEF: Before Head Start 1:OUT:Same with Last Outer Presser	0	Selection
CUR	Intermediate Presser Current	Intermediate presser current		1	2~8	4	Input
DLY	Intermediate Presser Up Delay	Delay the action to prevent running into mould	ms	1	0~255	0	Input
TYE	Intermediate Presser Type	Select type of intermediate presser			0:AIR:Air Valve 1:STP: Stepping 2:MAG:Magnet	0	Selection
PLP	Intermediate Presser Stroke Setting	Set intermediate presser vertical stroke.	0.1mm	2	0~180	150	Input
ZU8	Intermediate Presser Up Angle	Set up position for moving intermediate presser	Degree	1	0~360	100	Input
ZD8	Intermediate Presser Down Angle	Set down position for moving intermediate presser	Degree	1	0~360	0	Input
ZTM	Synchronization of Intermediate Presser	Input pattern at setting intermediate presser			0:OFF: Not Relating to Pattern Input 1:ON: Relating to	1	Selection

	at Inputting				Pattern Input		
PDD	Intermediate Presser Down Delay	Delay at lowering the intermediate presser		1	0~255	0	Input
MSP	Intermediate Presser Moving Speed	Set the moving speed of intermediate presser when CUR=8			8-17	13	Input

**10、Winding:**

Code	Brief	Details	Unit	Step Length	Range	Default Value	Type
SPD	Winding Speed	Set wind speed	100RPM	1	2~27	13	Input
STP	Winding Device Stop Method	Set method to stop winding			0:UTS: Release Pedal to Stop winding 1:RTS:Step Pedal again to stop winding 2:TTS: Set Time to Stop Winding	1	Selection
TPD	Set Stop winding time (Unit Second)	Set the time to stop winding (Unit Second)	s	2	2~498	30	Input

**11、Feed Method:**

Code	Brief	Details	Unit	Step Length	Range	Default Value	Type
TYP	Pressing Board Type	Select Pressing Board			0:AIR:Air-driven 1:MAG: Magnet 2ADP: Self-adopt	0	Selection
WEI	Weight of Pressing Board	Select the weight of pressing board			0:HIG: Light 1:MID:Middle 2:WEG:Heavy	1	Selection
HIG	Light Board (Air Amount L)	Light board (Air Amount L)		1	0~255	145	Input
MID	Middle Board (Air Amount M)	Middle board (Air Amount M)		1	0~255	0	Input
WEG	Heavy Board	Heavy board		1	0~255	0	Input

	(Air Amount H)	(Air Amount H)					
STP	Sewing Type Selection	Select sewing type			0:TIN:Thin 1:MID:Middle 2:TIC:Thick	0	Selection
THI N	Thin Fabric	Thin fabric thickness		1	0~255	0	Input
MID	Middle Fabric	Middle fabric thickness		1	0~255	0	Input
THC K	Thick Fabric	Thick fabric thickness		1	0~255	0	Input
SUI	Pattern-making Follows Action Setting	Pattern-making follows the action setting			0:OF: Forbid 1:ON: Permit	1	Selection
SMD	Start Frame-moving Angle Adjustment	Adjust the start frame-moving angle	Degree	1	-50~+50	0	Input
STD	End Frame-moving Angle Adjustment	Adjust the end frame-moving angle	Degree	1	-50~+50	0	Input
SAE	Frame-moving Initial Angle Setting	Set the initial frame-moving angle with speed over 1800rpm	Degree	1	135-280	135	Input
MM D	Move Mode	XY axis action mode			0:ETM: Equal Time 1:NTM: Unequal Time	0	Selection

## 12、Speed:

Code	Brief	Details	Unit	Step Length	Range	Default Value	Type
HSP	High Speed	Set high speed	100RPM	1	2~27	23	Input
LSP	Low Speed	Set low speed	100RPM	1	2~27	2	Input
MHS	Middle High Speed	Set middle high speed	100RPM	1	2~27	15	Input
MLS	Middle Low Speed	Set middle low speed	100RPM	1	2~27	10	Input
EDL	Feed Delay	Delay after feeding action		1	0~9999	0	Input
JDL	Step Moving Delay	Delay after step moving action		1	0~9999	0	Input
IDL	Pattern-making	Delay after		1	0~2700	0	Input

	Delay	pattern-making action					
SEW	Sewing Speed	Set sewing speed		1	0~9	4	Input
FED	Feed Speed	Set speed at empty feed section		1	0~9	4	Input
FRM	Frame-moving Speed	Set frame-moving speed		1	1~3	3	Input
SPS	Returning to Start Point Speed	Set speed for returning to the start point		1	0-9	4	Input
HPS	Search Origin Speed	Set speed for searching origin		1	5~10	5	Input
SMS	Single Step Move Speed	Set speed of moving of single step		1	0~40	30	Input

### 13、 Thread-trimming Order:

Code	Brief	Details	Unit	Step Length	Range	Default Value	Type
TRM	Trimming Switch	Trimming Switch			0:OFF:Off 1:ON:On	1	Selection
SPD	Trimming Speed	Trimming Speed	10RPM	1	20~40	40	Input
ANG	Needle Position Angle After Trimming	Needle position angle after trimming			0:UP: Upper Needle Position 1:DED: Upper Dead Point	0	Selection
DLY	Thread-trimming delay	Thread-trimming delay	0.01s	1	0~255	12	Input
TST	Trimming Output Start Time/ Angle	Trimming output start time/ angle	mm/ Degree	2	0~998	210	Input
TET	Trimming Output End Time/ Angle	Trimming output end time/ angle	mm/ Degree	2	0~998	0	Input
TMD	Trimming Mode	Select thread-trimming order			0:FST:fast 1:GEN:Gentle	1	Selection
OPT	Thread-loosing Delay	Thread-loosing delay		1	0~255	0	Input
OSA	Thread-loosing Start Time/Angle	Thread-loosing start time/angle	mm/ Degree	2	0~998	300	Input

OEA	Thread-loosing End Time/Angle	Thread-loosin g end time/angle	mm/ Degree	2	0~998	0	Input
-----	----------------------------------	--------------------------------------	---------------	---	-------	---	-------

**14、LCD Screen:**

Code	Brief	Details	Unit	Step Length	Range	Default Value	Type
WRN	Warning of Buzzer	Set the warning voice of buzzer			0:OFF: No Voice 1:PAR:Panel Voice 2:ALL:Panel + Warning Voice	2	Selection
DEL	Touching Panel Sensitivity Adjustment	Adjust sensitivity of touching panel		1	1~5	3	Input
LIG	Back Light Adjustment	Adjust the back light		1	20~100	100	Input
ATO	Back Light Auto Turn-off	Auto turn-off of back light			0:OF:Not Auto Turn-off 1:ON:Auto Turn-off	0	Selection
TIM	Back Light Auto Turn-Off Waiting Time	Time for waiting auto turn-off of back light	Minute	1	1~9	3	Input
BTN	Button Display Style	Set the display style of the button in Test Mode and Function Mode			0:ICN: Icon 1:TXT: Text	0	Selection
BKC	Background Color Setting	Set the background color of the pattern display area in main interface 0: Block 1: Dark Blue 2: Red 3: Green 4: Blue 5: Purple 6: Yellow		1	0~6	0	Input
SES	Display Style of Pattern Selection	Set the display style of pattern-selection interface Note: only the used patterns can be			0:CLS:Classic (Display Number List) 1:SHP: Display Pattern Shape	0	Selection

		displayed.					
ZST	Scaling Method	Scaling Method			SQA: square L-W: length-width	SQA	Selection
RBS	Return to Sewing Start Hotkey	Return to sewing start hotkey			OFF ON	OFF	Selection
DPN	Display Needle Drop Point	Whether to display needle drop point			NO YES	NO	Selection
CCS	Continuous Sewing of Combination Pattern	Whether to sew combination pattern continuously			NO YES	NO	Selection
LPT	Support Pattern of Large Number of Stitches	Support pattern of large number of stitches			OFF ON	OFF	Selection
SCS	Main Interface Function Hotkeys	Whether to display the function hotkeys on the main interface			OFF ON	ON	Selection
CSM	Pattern Transforming Method	Set the pattern transforming method			STI: stitch ELE: element	STI	Selection
PSU	Scaling Unit	Set the scaling unit			%: percentage SIZ: size	%	Selection
MSM	Scaling Method for Multiple Sewing	Set the scaling method for multiple sewing			VAR: variable interval FIX: fixed interval	VAR	Selection
PMR	Return after Modification	Set the return method after finishing modification			FUN: function selection CNT: continue modification	FUN	Selection
OFM	Multiple Sewing, Deviating Sewing Modification Method	Set the modification method for multiple sewing and deviating sewing			REL: relative modification ABS: absolute modification	REL	Selection

**15. Others:**

Code	Brief	Details	Unit	Step Length	Range	Default Value	Type
------	-------	---------	------	-------------	-------	---------------	------

NLD	Needle-cooling	Needle cooling device			0:OFF:No 1:ON:Yes	0	Selection
PEM	Permission of Single Pedal Operation	Permission of single pedal operation			0:OFF:Forbidden 1:ON:Permitted	0	Selection
LAG	Language Selection	Language selection			0:CH:中文 1:EN:English	0	Selection
SSW	Sound Setting	Set sound function			0:OFF:Off 1:ON:On	1	Selection
VOL	Volume of Operation Voice	Volume at pressing button			30~63	50	Input
NSW	Network Connection	Activate the network connection			0:OFF:Off 1:ON:On	0	Selection
LED	LED Brightness	For machine with LED output, set the brightness of LED			0-100	50	Input
DLY	Thread Loosing Device Open Delay When Threading	When threading, the opening time of the thread loosing device when the intermediate presser goes down	S		0-255	0	Input
CUR	Thread Loosing Device Open Current When Threading	The value of the thread loosing device open current when threading			0-255	0	Input
SEC	Automatically Add Sub-origin after First Empty Feed	Whether to add sub-origin automatically after the first empty feed			OFF ON	OFF	Selection
SEC	Whether Intermediate Presser Moves Along with Pattern-designing	Edit whether intermediate presser moves along with pattern-designing			OFF ON	ON	Selection
MAH	Applicable to	Set the			0-10	0	Input

	Machine Type with Automatic Feed Function	parameters of machine type with automatic feed function					
DSP	Start Delay after Stepping Pedal	Set the activation of start delay after stepping pedal			OFF: prohibited ON: allowed	OFF	Selection
DEP	Start Delay Time after Stepping Pedal	Set the start delay time after stepping pedal			0~200	0	Input
FEP	Empty Feed Stitch Length	Set the stitch length when empty feed	mm		10~120	12	Input
PTP	PLT Switch Stitch Length Setting	Set the PLT switch stitch length			10~127	30	Input

### 16、Repair & Maintenance:

Code	Brief	Details	Unit	Step Length	Range	Default Value	Type
NRT	Needle Replacement Left Value	Left stitches for needle replacement	1000 Stitch	1	0~9999	0	Input
NST	Needle Replacement Set Value	Set stitches for needle replacement	1000 Stitch	1	0~9999	0	Input
HRT	Clearing Time Left Value	Left hours for clearing	Hour	1	0~9999	0	Input
HST	Clearing Time Set Value	Set hours for clearing	Hour	1	0~9999	0	Input
ORT	Oil Replacement Left Value	Left hours for oil replacement	Hour	1	0~9999	0	Input
OST	Oil Replacement Set Value	Set hours for oil replacement	Hour	1	0~9999	0	Input
BLR	Bobbin Thread Replacement Residual Value (Stitch Number)	Click in, but unable to input					
BLS	Bobbin Thread Replacement Set Value (Stitch Number)	Bobbin thread replacement set value			0~6000	0	Input

OLI	Oiling Interval Time	Oiling interval time	S		0~999	0	Input
OLW	Oiling Work Time		MS		0~9999	0	Input

[Note]: Parameters, like NRT, HRT and ORT can not be set. User can only check them in the Internal Parameter Setting Interface

[Note]: After the modification of parameters for repair and maintenance, the corresponding parameters of "Left Value" will be changed to the set value

[Note]: After the parameter value of repair and maintenance are set (value over 0), the corresponding counting function for repair and maintenance will be activated as well.



### 17、Special:

Code	Brief	Details	Unit	Step Length	Range	Default Value	Type
HSP	Max Speed	Max Speed	100RPM	1	2~27	23	Input
MAE	Main Stop Angle	Stop angle of main shaft motor	Degree	1	30~80	53	Input
DEB	Letter Embroidery	Activate letter embroidery			0:OF:Turn off Letter Embroidery Function 1:ON: Turn on Letter Embroidery Function	1	Input
DAE	Upper Dead Point Angle	Set angle from stop point to upper dead point	Degree	1	0~50	3	Input
RSC	Stitch Length Deceleration Curve	Select built-in stitch length deceleration curve		1	0-6	5	Input
HSL	Max Stitch Length at Keeping Speed	Max stitch length at keeping highest speed	0.1mm	1	1-127	0	Input
MTS	Main Shaft Motor Type Selection	Support 550W & 750W			0-550W 1-750W	1	Selection
xDIR	X Motor Rotation Direction	Switch X-axis stepping motor rotation direction			POS: positive direction NEG: negative direction	POS	Selection
yDIR	Y Motor Rotation	Switch Y-axis stepping			POS:正向 NEG:反向	POS	Selection

	Direction	motor rotation direction					
zDIR	Z Motor Roatation Direction	Switch Z-axis stepping motor rotation direction			POS: positive direction NEG: negative direction	POS	Select ion
ADR	Main Control Burned-in Address	The write-in address of the main control update program stored in the U disk			655360 ~917504	917504	Input
CVE	Parallel Cureve Algorithm	Set the parallel curve generated during pattern edition			A1: algorithm 1 A2: algorithm 2	A1	Select ion
MUS	Reverse Sewing Algorithm under Multiple Sewing	Set the reverse sewing of multiple sewing during pattern eddition			ALL: by section SE: end to end	ALL	Select ion
TID	Pattern Recognizati on Setting	Pattern recognition setting			OFF ON	OFF	Select ion
PFT	Pattern Corresponding No. Section				0~9 0:001~031 1:101~131 2:201~231 3:301~331 4:401~431 5:501~531 6:601~631 7:701~731 8:801~831 9:901~931	0	Input
PXO	X Diviation of Marker	X diviation of marker			-500~500	0	Input

PYO	Y Diviation of Marker	Y diviation of marker			-200~200	0	Input
PSP	Marker Running Speed	Marker running speed			1~9	1	Input
TTY	Pattern Recognizati on Device	Pattern recognition device			SEN: sensor BAR: bar-code scanning device	SEN	Select ion
ICS	Communica tion Speed Improve ment	Communica tion speed improvement			OFF ON	OFF	Select ion

### 2.8 Test Mode

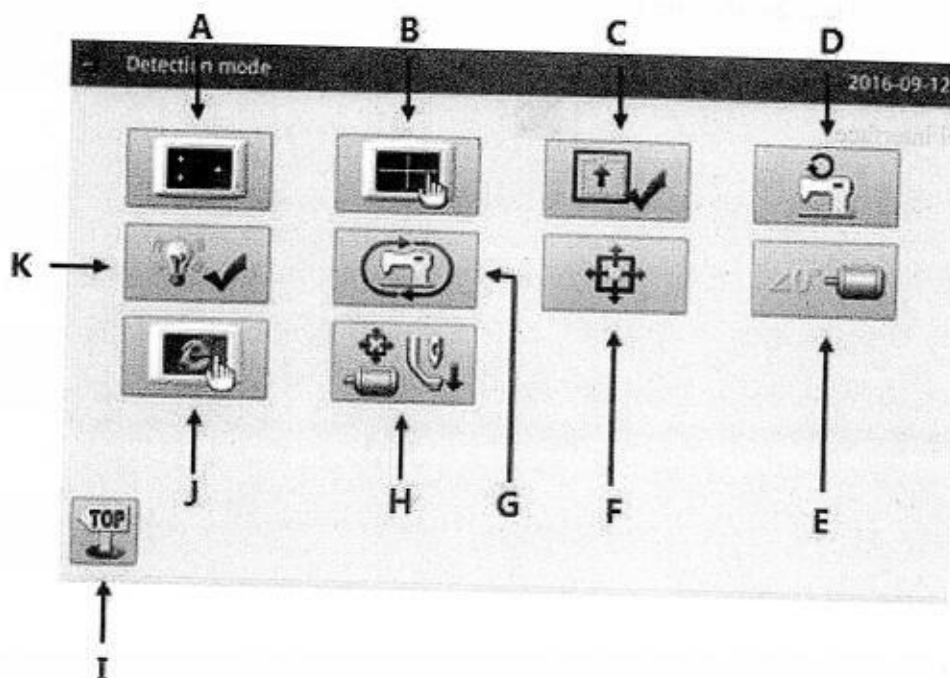
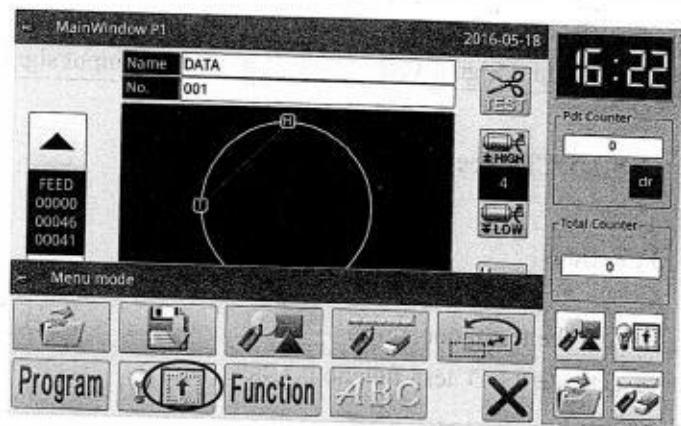

In main interface P1 (or P2),  
 press  to activate the catalogue mode, and then press   to enter the test mode.



**Functions:**

No.	Functions	Content
A	LCD Test	Test LCD displayer
B	Touching Screen Correction	Correct the touching screen
C	Input Signal Test	Test the input signal of switches and sensors
D	Speed Test	Test the speed of main shaft motor
E	Main Motor Installation Angle Adjustment	Display and set the installation angle of main shaft motor
F	XY Motor Origin Test	Test the motor origins of X /Y motors
G	Continuous Running	Set continuous running parameter and enter aging status
H	Intermediate Presser Function Test	Used to test intermediate presser
I	Quit	Quit test mode and return to main interface
J	Network Setting	Set the relating parameters of network
K	Output Signal Test	Test the output signal of pressers and thread-trimming devices

**2.8.1 LCD Test****Function:**

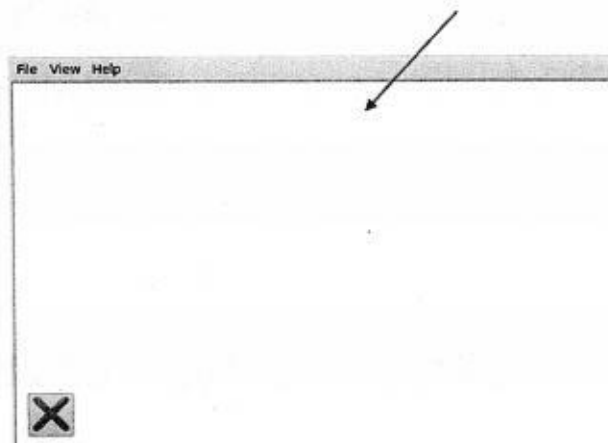

In the test mode, press  to activate LCD test function. Click the area other than  to have LCD screen display white, black, red, green and blue so that user can judge whether the LCD screen has problem.

Press  to return to the upper level interface.



## 2.8.2 Touching Screen Correction

### Functions:

Under test mode, press  to display the interface for ID input, as shown on the right. Then input the ID and press  to enter touch screen correction function.

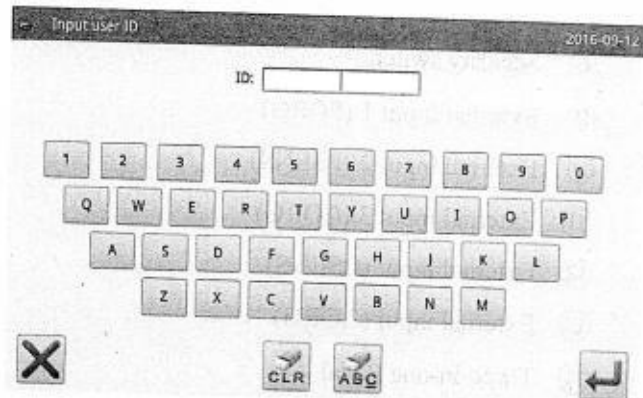

User has to correct 5 spots. The touching pen is recommended to be used at touching the cross icon on the interface. After the correction, the system will display the result of this operation

**[Note]:** During the correction, please perform the operation strictly according to the position of the cross icon, otherwise the touching screen may be unable to be used normally after the correction.



## 2.8.3 Input Signal Test

### Function:

In the test mode, press  to activate the Input Signal Test Function.

ON: Activation

OFF: Deactivation

Types of Input Signal:

- ① Start switch (Pedal)
- ② Presser switch (Pedal)
- ③ Pause Switch
- ④ Thread-breakage Detection

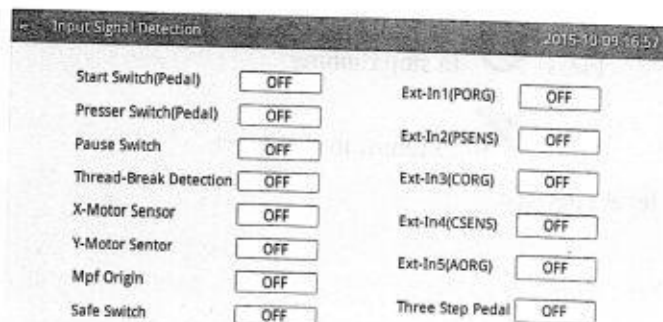



- ⑤ X Motor Sensor
- ⑥ Y Motor Sensor
- ⑦ Intermediate presser origin
- ⑧ Security switch
- ⑨ External input 1 (PORG)
- ⑩ External input 2 (PSENS)
- ⑪ External input 3 (CORG)
- ⑫ External input (CSENS)
- ⑬ External input (AORG)
- ⑭ Three-in-one Pedal

Press  to return to the upper level interface.

### 2.8.4 Main Shaft Speed Test

#### Functions:

In the test mode, press  to enter the main shaft speed test function.

Use  and  to set the aim speed of main shaft motor. After

user presses , the main shaft motor will rotate at the set speed. At this moment, the actual speed will be displayed in the input column of actual speed.

Press  to stop running

Press  to return to the upper level interface.

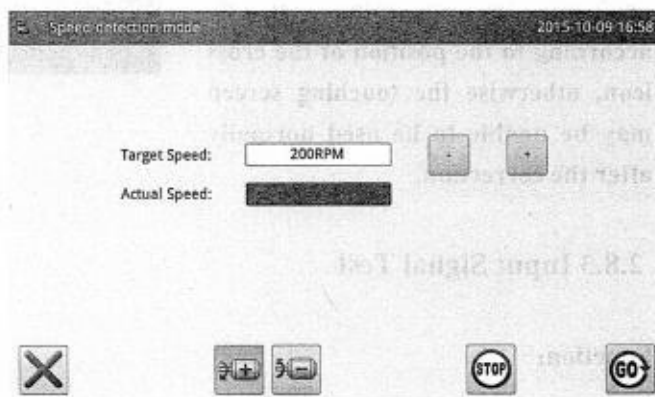

## 2.8.5 Output Signal Test

### Functions:

In the test mode, press  to activate the output signal test function.

In this interface, user can press output signal button to test the status of output signals of solenoids

Types of Output signals:

- ① Thread-wiping
- ② Thread-trimming
- ③ Presser
- ④ Intermediate presser
- ⑤ Thread-loosing
- ⑥ Reverse Presser
- ⑦ Auxiliary air valve 1
- ⑧ Auxiliary air valve 2
- ⑨ Auxiliary air valve 3
- ⑩ Auxiliary air valve 4
- ⑪ Auxiliary air valve 5

Press  to return to the upper level interface.

**[Note]: The sewing machine will have the actual movement.**

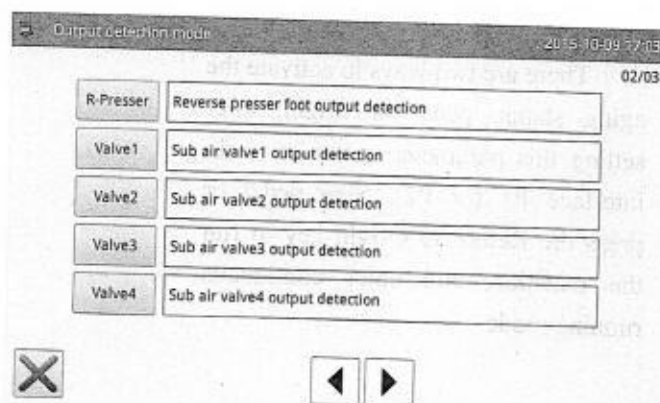
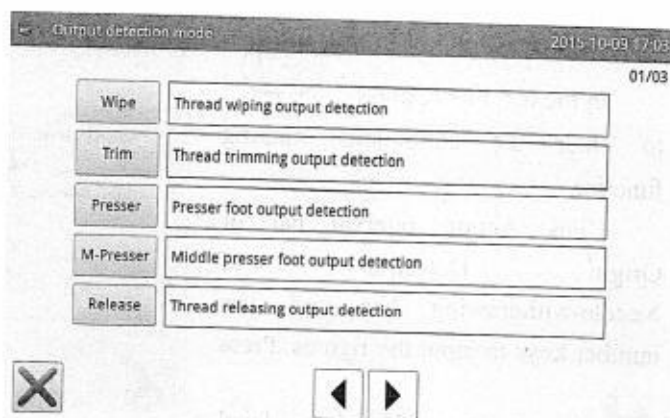

### 2.8.6 Continuous Running

**Function:**

In the test mode, press  to enter the continuous running function

Click Action Interval bar or Origin Detection of Needle-withdrawing bar and use number keys to input the figures. Press

 to return to the upper level interface.

There are two ways to activate the aging status: pedal or origin; after setting this parameter, return to main interface P1 (or P2). Step pedal or press the Return to Origin key to run the machine, and enter continuous running mode.

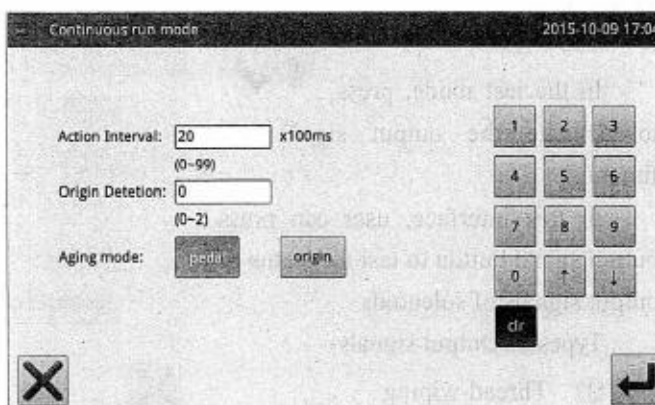

### 2.8.7 XY Motor Origin Test

**Functions:**

In the test mode, press  to activate the XY Motor Origin Detection Function.

In this interface, use direction keys to move XY motor. During this process, the system will display the ON/OFF status of the sensors.

- ON: Sensor Detected
- OFF: Sensor Undetected

Press  to return to the upper level interface.

**[Note]: The sewing machine will have the actual movement.**

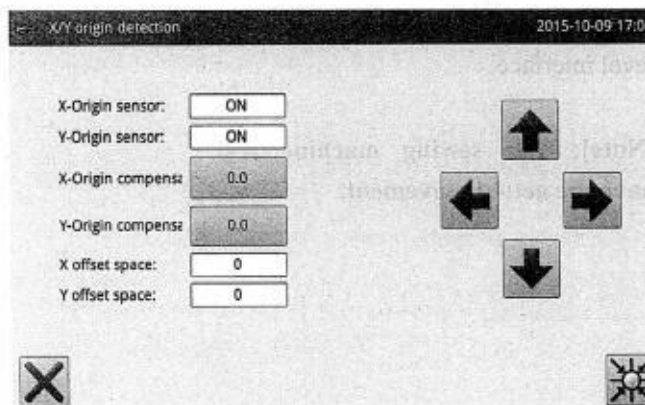

## 2.8.8 Main Motor Installation Angle Adjustment

### Functions:

In the test mode, press  to enter the main motor installation angle adjustment.

In the current interface, remove the main motor, turn the hand wheel to lift the needle bar to the highest point and turn the main shaft joint to adjust the electrical angle within less than 30 degree. After that, reinstall the main

motor and press  to confirm.

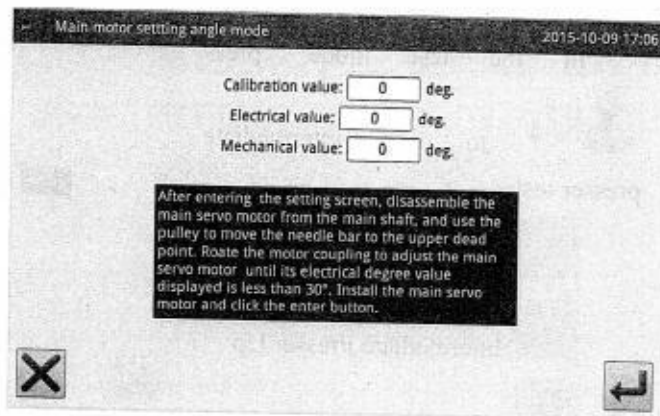



## 2.8.9 Network Setting

### Functions:

In the test mode, press  to enter the network setting function. If user needs the network function of operation panel, he should set the relating parameters of network.

Use number keys to input parameters, make sure the "IP Address" and "Server IP" are within

the same section. Use  and  to move the cursor. After finishing the setting, press the Connection key to get connected with the computer via internet.

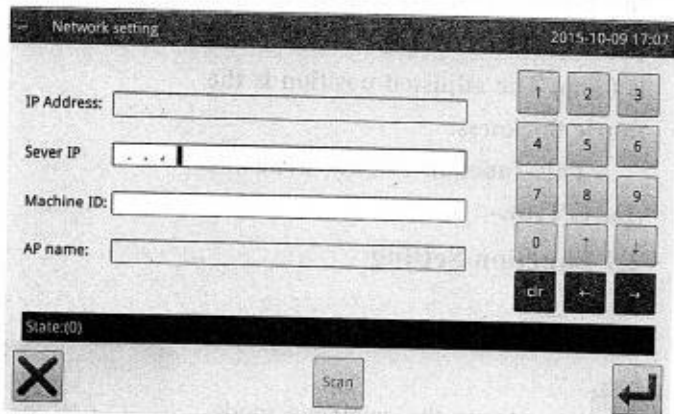

### 2.8.10 Intermediate Presser Test

**Functions:**

In the test mode, press



to enter intermediate

presser test.



:Intermediate Presser Down



:Intermediate Presser Up



:Shift Intermediate Presser

**Position**

[Note]: In this interface, step pedal to return the intermediate presser to origin (the highest position of intermediate presser); the highest point is 71mm, middle point is 35mm, and the lowest point is 0mm. The adjusted position is the fabric thickness.

This function is only available for G Type.

### 2.9 Function Setting

In main interface P1 (or P2), press



to activate the catalogue mode,

and then press **Function** to enter the Function Setting Mode.

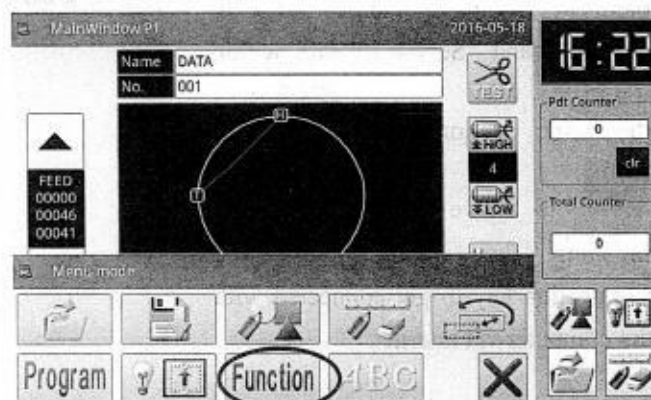
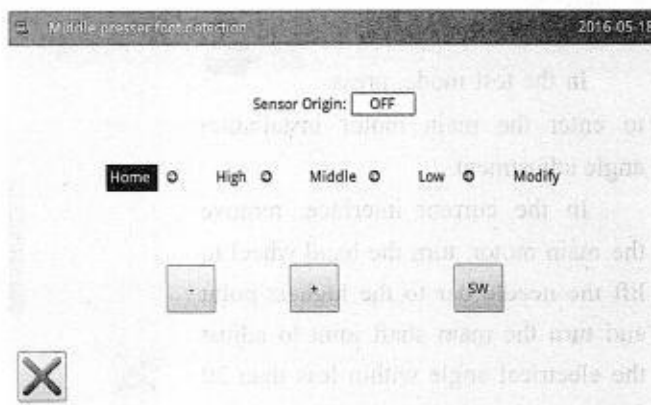

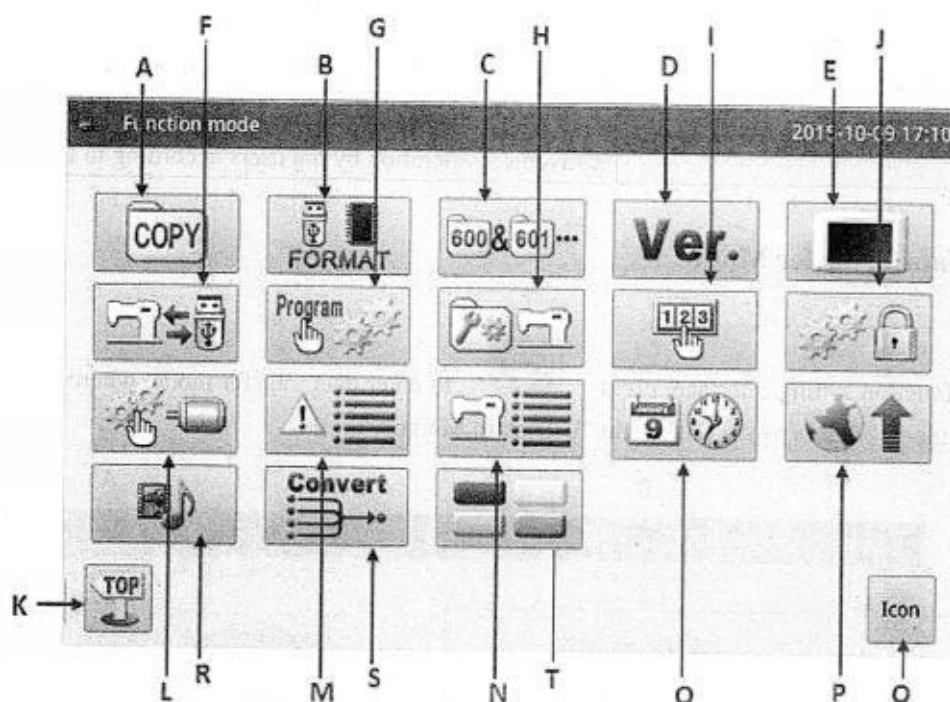
**Functions:**

No.	Functions	Content
A	Data Transfer	Transfer pattern file between memory and U disk
B	Formatting	Initialize the U disk, memory and pattern number hotkeys.
C	Pattern Connection	Edit combined pattern
D	Version Inquiry	Inquire the version of system software
E	Display Setting	Set background light, keyboard lock, lightness and so on
F	Back-up Parameter Recovery	Save parameter values into U disk for the parameter recovery in future
G	Default Parameters	Recovery and self-defined read-write function of the default parameter values
H	Pattern Number Hotkey Edition	Edit the content of pattern number hotkey
I	Password Mode	Provide periodical password function
J	Parameter Encryption	Set passwords for each operation entrance in parameter mode.
K	Quit	Return to main interface
L	Motor Configuration	Enter main motor, stepping current configuration mode
M	Alarm Record	Check the alarm statistic information
N	Running Record	Check running information of machine
N	Date & Time Setting	Set data and time
O	Time Setting	Set the date and time
P	Software Update	Enter software update mode
Q	Shift between Icon and Description	Shift between the icon and description of the hotkeys
R	Player	Play audio in the formats of mp3, AVI, etc.

S	Pattern Transformation in Batch	Change the patterns of non-standard formats into standard formats. <b>Note: standard format means nsp format.</b>
T	Hotkeys Setting	Edit and display hotkeys in the main interface for convenient operation by the users according to their habits



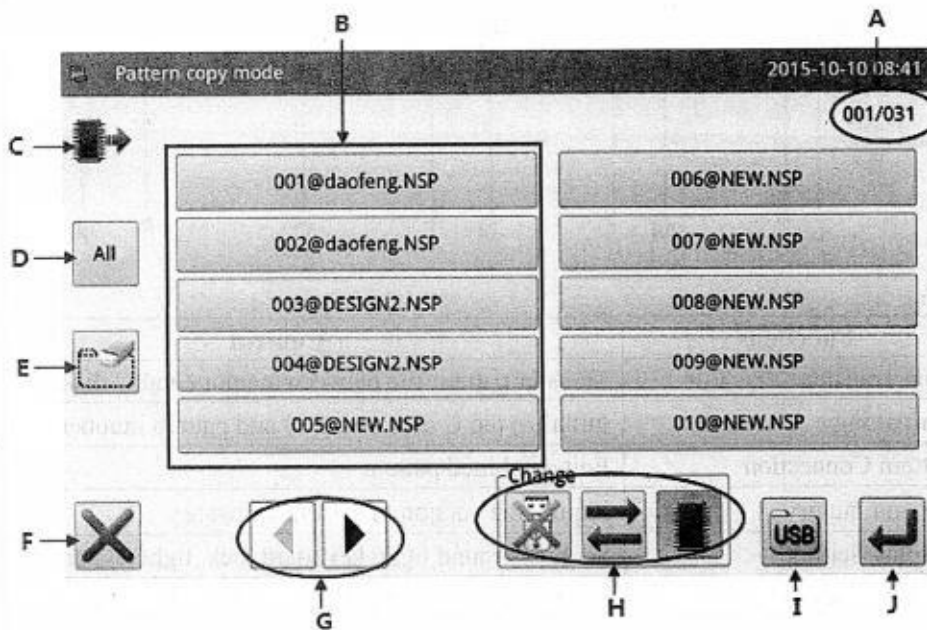

### 2.9.1 Data Transfer Mode

In function setting interface, press **COPY** to enter data transfer mode, where two ways are provided: “Memory to U Disk” and “U Disk to Memory”



**Functions:**

No.	Description
A	Page information, displaying the present page/total pages
B	Pattern List
C	: Memory Pattern List : U Disk Pattern List
D	Select All Patterns
E	Delete Pattern
F	Quit and Return to Upper Interface
G	Page Key
H	Load pattern from memory or U disk : Activate the Memory Load Mode: At this moment, user cannot load



	<p>pattern from U disk.</p> <p> : Deactivate the Memory Load Mode: At this moment, user can load pattern from U disk.</p> <p> : Activate the U Disk Load Mode: At this moment, user can not load pattern from memory.</p> <p> : Deactivate the U Disk Load Mode: At this moment, user can load pattern from memory.</p> <p> : Shift between U Disk and Memory</p>
I	Display the file folders of the U disk
J	Enter



## Operation:

### 1、 Copy Mode Selection

The default setting is to copy pattern from memory to U disk, user can press  to change the copy mode.

### 2、 File Selection

Select the pattern for copy from the pattern list (here, we select No.400, 401 and 600). If the patterns are so many, please use   to turn the page.

For copying all the patterns, please press  and please press  to delete patterns.

### 3、 Confirm the Copy

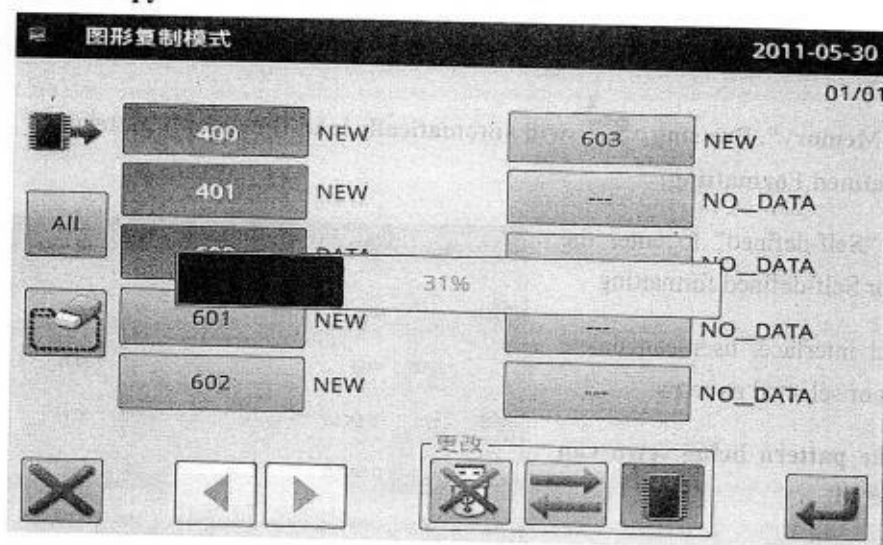

After selection, please press  and then the system will display "Copy the Selected

Pattern”, where user can press  to perform the operation. If the pattern is copied from memory to U disk, the system will automatically create a catalogue naming “dh\_pat” at the base catalogue of U disk and save the pattern under that catalogue.

**[Note]: During the copy process, if the memory contains the pattern with the number same to that of the pattern in the U disk, the new pattern will replace the old one.**

### 2.9.2 Formatting Mode

In function setting interface, press  to activate formatting mode

There are four formatting methods in this interface: USB formatting, Memory formatting, Self-defined formatting and Pattern number hotkey formatting

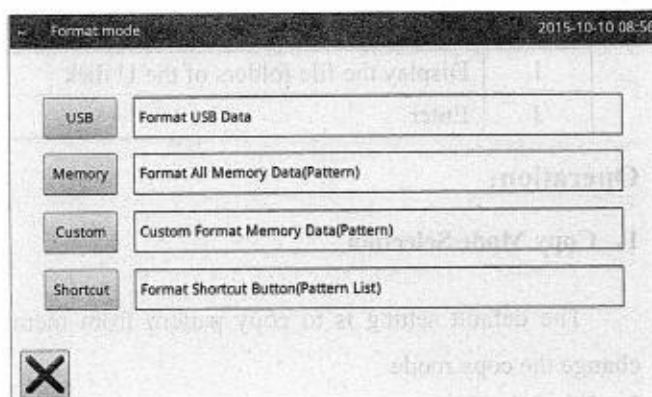



#### 11、 USB Formatting:

Press “USB” to delete all the patterns in the U disk. So user need back up the data if necessary.

#### 2、 Memory Formatting:

Press “Memory” to delete all the patterns in the memory.

**[Note]: After the memory formatting, pressing  will have system display “Pattern Not**

**Found in Memory”. Pressing  will automatically load the default patterns.**

#### 3、 Self-defined Formatting:

Press “Self-defined” to enter the interface for Self-defined formatting

In that interface, user can delete all patterns or selected patterns.

**[Note]: The pattern being sewn can not be deleted.**

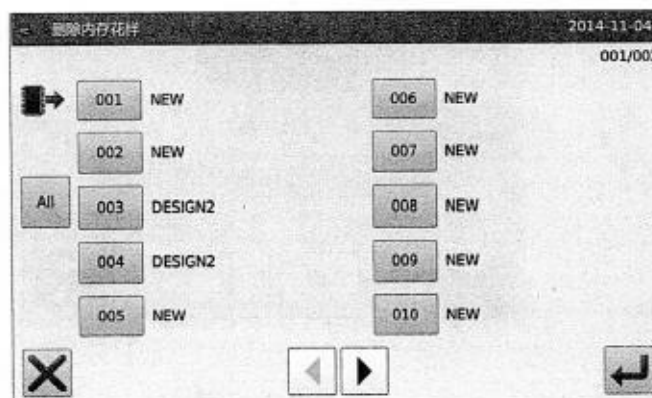

#### 4、 Hotkey Formatting:

Pressing "Hotkey" to delete the content of the hotkeys of pattern number.

[Note]: After the hotkey formatting, pressing **X** will have system display "Pattern List (Hotkey) Is Empty". Pressing **↩** will automatically load the current pattern number to the hotkey.

### 2.9.3 Pattern Connection Mode

In function setting interface, press **600&601** to enter Pattern Connection Mode. The pattern connection mode is mainly used to create and edit the combined pattern, which is to perform the combination edition on the basis of the existing patterns. The pattern used in combined pattern is called as sub-pattern.

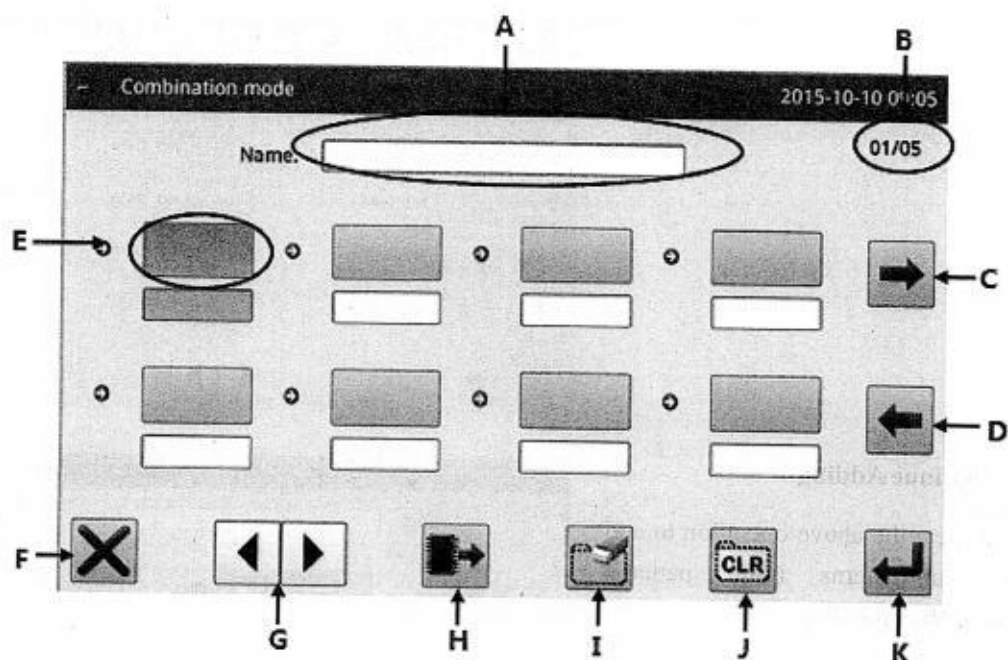



#### Function:

No.	Description
A	Name of Combined Pattern
B	Page
C	Load Combined Pattern
D	Save Combined Pattern
E	Display Sub-pattern
F	Quit & Return to Previous Interface
G	Page Key
H	Add Pattern from Memory to Combined Pattern
I	Delete Sub-pattern

J	Cancel Combined Pattern
K	Enter

**Operation:**

**1、 Select a Sub-pattern**

Press  to enter Load Mode and select the pattern to add (select pattern No.612 as an example). Press  to confirm it.

**[Note]:** Patterns should be added to the combined pattern in order.

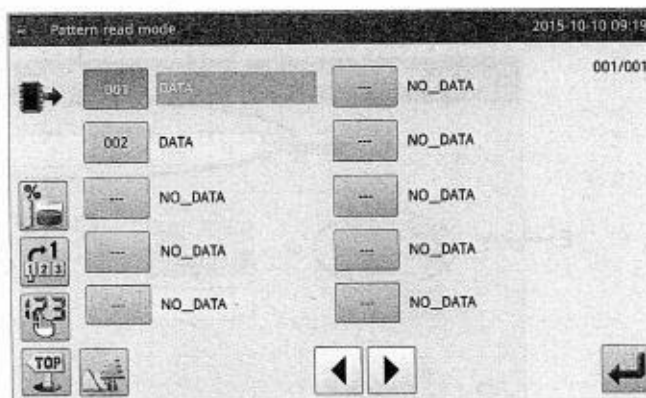
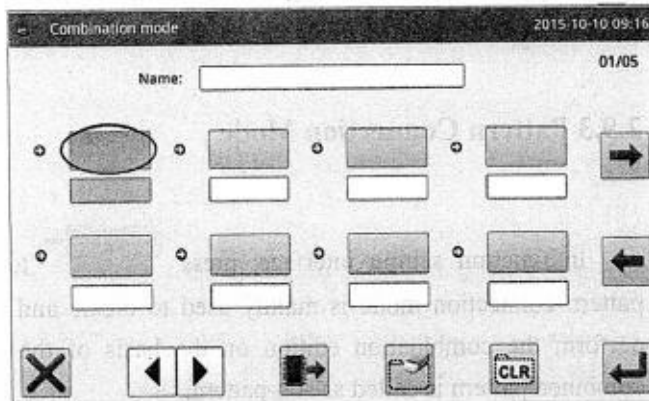

**2、 Continue Adding**

Repeat the above operation to add more sub-patterns (Add patterns No.600, 602 and 401)

If user wants to delete one of them, please select the number of the sub-pattern and then press .

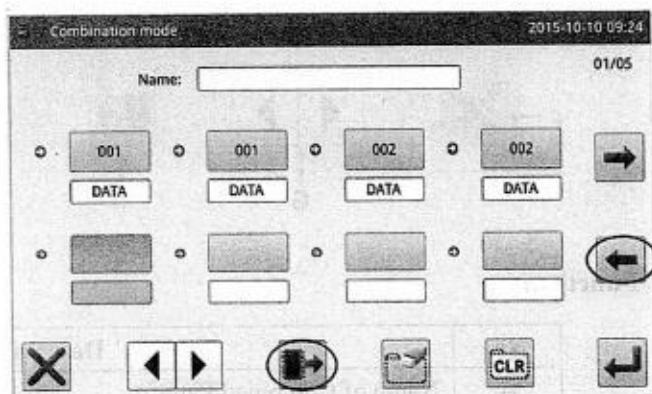

### 3、 Save the Combined Pattern

Press  to enter the mode for saving combined pattern.

Name the combined pattern and press  to confirm it. For other operations within this interface, please refer to [2.6 Save Pattern].

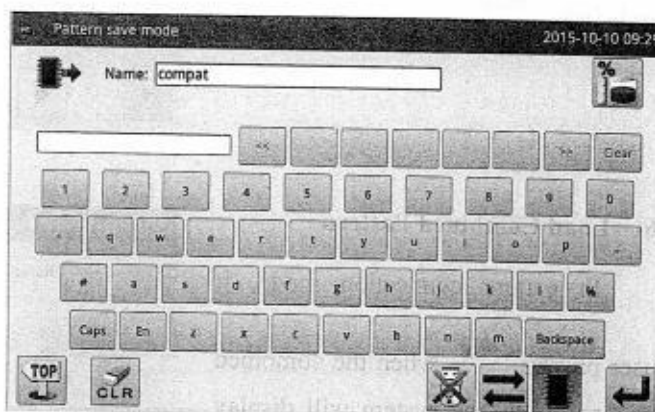
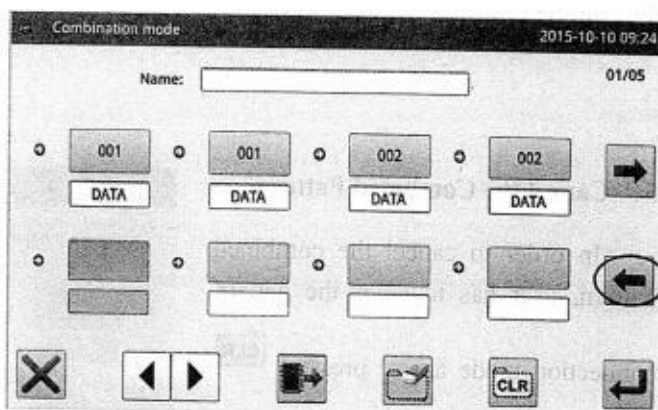

### 4、 Return to Main Interface

After finishing edition of the combined pattern, press  to return to main interface.

As shown in right figure, there are some differences between the combined pattern sewing interface and the normal pattern sewing interface.

① The name of combined pattern is displayed behind the number and the name of the current sub-pattern will be displayed at the name area.

[Note]: If the combined pattern has no name, nothing will be displayed.

② The original pattern number hotkeys will display the sub-patterns in this combined pattern. Click the sub-pattern to start the sewing from

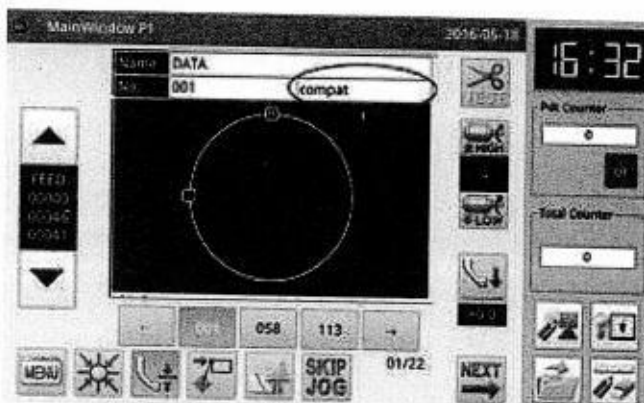
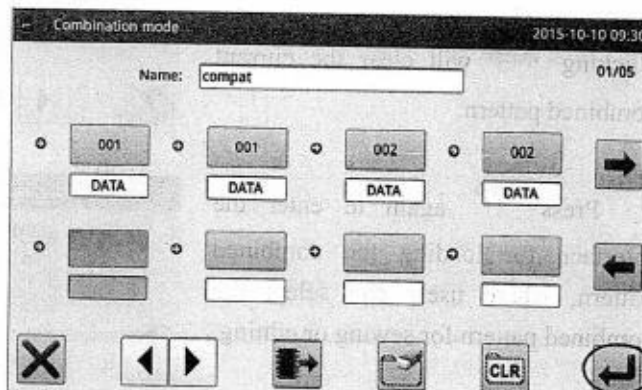

that sub-pattern.

### 5、 Cancel the Combined Pattern

In order to cancel the combined pattern, user has to enter the pattern connection mode again, presses **CLR** and clicks ↩.

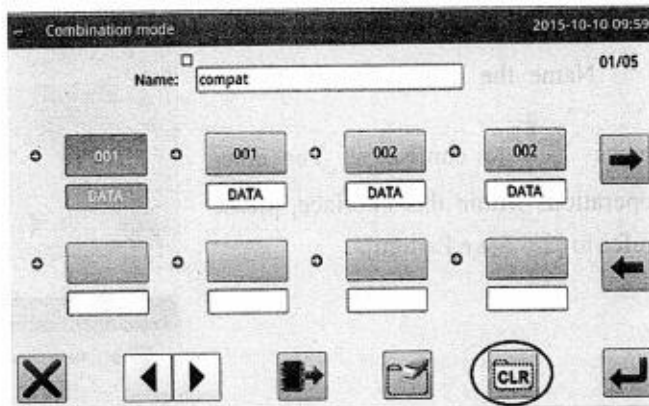

### 6、 Load Combined Pattern

In pattern connection mode, if user presses → when the combined pattern exists, the system will display "Clear Current Combined Pattern". Clicking **CLR** will clear the current combined pattern.

Press → again to enter the interface for loading the combined pattern, where users can select the combined pattern for sewing or editing.

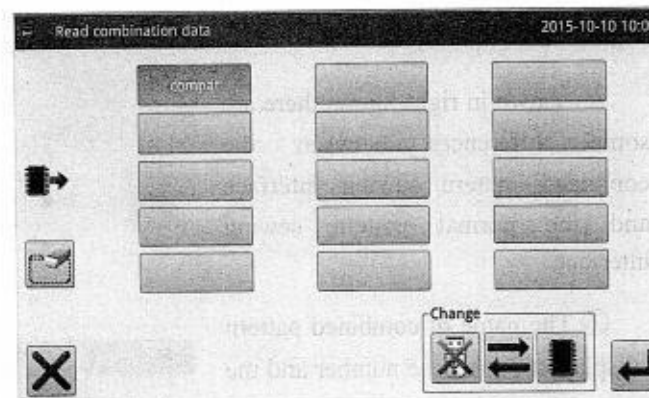
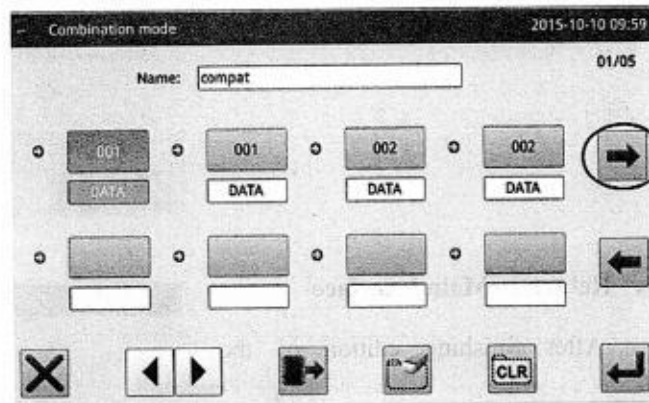

## 2.9.4 Version Inquiry Mode

In function setting interface, press **Ver.** to enter version inquiry mode.

Press  to output the software version to the base catalogue of the U disk with name "version.png".

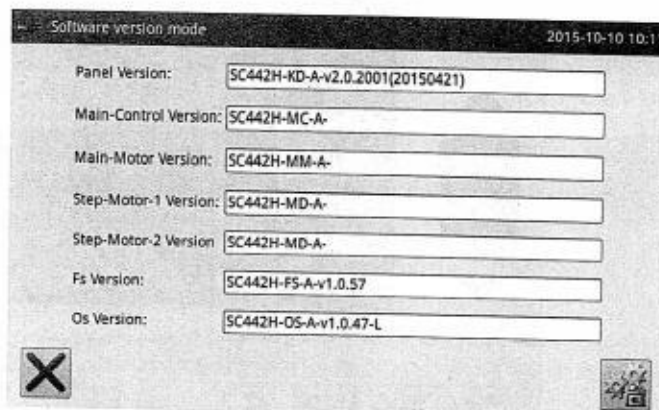

## 2.9.5 Display Setting Mode

In function setting interface, press  to enter display setting mode, where user can perform the settings about the display, operation and so on.

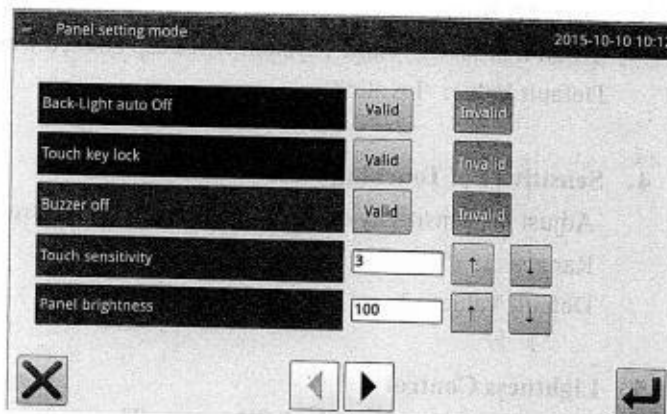

### 1、 Backlight Auto Turn-off

By the set time, the screen backlight will be turned off automatically.

Range: 1~9 min

Default Value: Invalid

Releasing Method: if the backlight is off, user can touch any position of the screen to turn it on.

### 2、 Keyboard Lock

When it is set as "Valid", all the buttons will turn to grey in display and become useless.

Pressing  will directly return to main interface P1.

Default Value: Invalid

Releasing Method: Hold the title bar at main interface P1 for over 5 seconds, until user hear "Bee--m". After that the lock is released. (After the releasing, this function will be set as Invalid.)

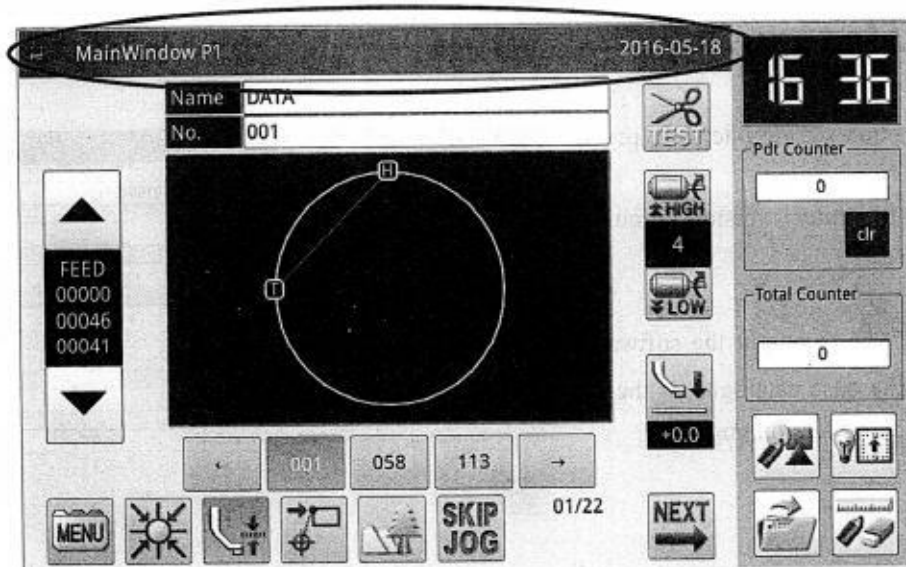

### 3、 Turn off Buzzer

When it is set as "Valid", system will keep silence when user presses button.

Default Value: "Invalid"

### 4、 Sensitivity of Touching Panel

Adjust the sensitivity of the touching panel. The larger value means the higher sensitivity

Range: 1~5

Default Value: 3

### 5、 Lightness Control

Adjust the lightness of the LCD screen. The larger value is, the lighter will be

Range: 1~100

Default Value: 100

### 6、 Button Display Style

Set the display style of some buttons. After the successful setting, the button display under interfaces of "Catalogue Mode", "Test Mode" and "Function Setting" will be changed

Range: 0~1 (0: Icon, 1: Text)

Default Value: 0

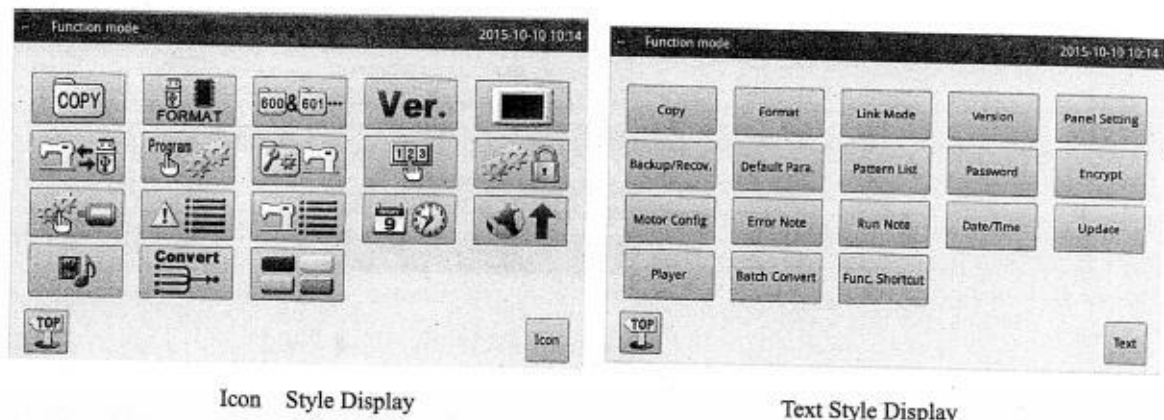

Icon Style Display

Text Style Display

### 7、 Background Color Setting

Set the background color of the pattern display area in main interface

Range: 0~6 (0:Black, 1: Dark Blue, 2: Red, 3: Green, 4: Blue, 5: Purple, 6: Yellow)

Default Value: 0

### 8、 Display Style of Pattern Selection

Set the display style of the interface for loading patterns. Only the used patterns can be displayed.

Range: 0~1 (0: Number, 1: Shape)

Default Value: 0

Please refer to [2.5.5 Display Style of Pattern List]

### 9、 Panel Display Style

Adjust the panel display style

Range: 0~2 (0: plastique, 1: cleanlooks, 2: windows)

Default Value: 0

### 10、 Position of Assistant Information Bar

Set the position of the assistant information bar

Range: 0~1 (0: Right, 1: Left)

Default Value: 0

[Note]: After the setting, user has to restart the system

### 11、 Main Interface Background Color

Set the background color of the main interface

Press "Setting" to open the color board.

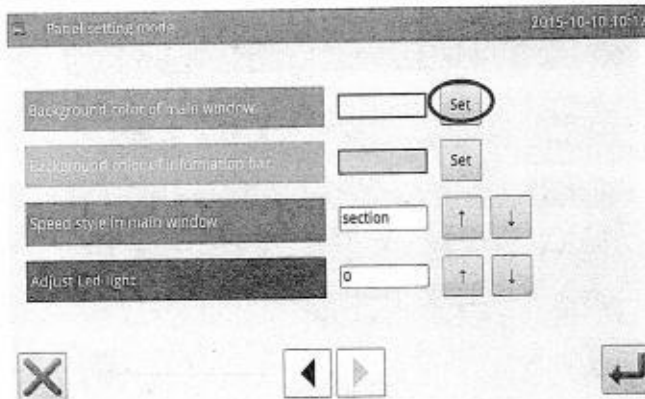

Select the color and press "OK" to confirm and turn off the color board

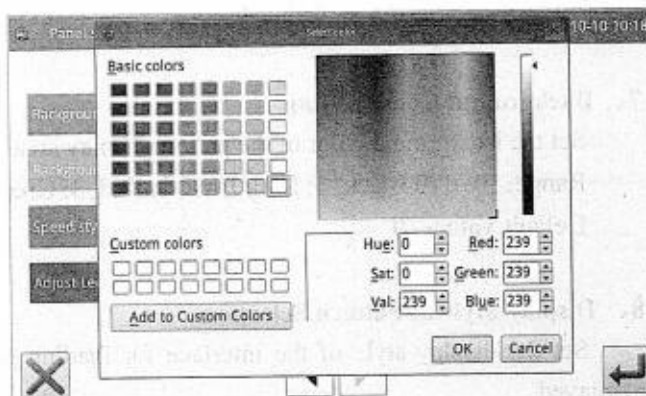

At this time, the color display area will show the selected color. Press  to return to the main interface P1 directly and change the background color of the main interface.

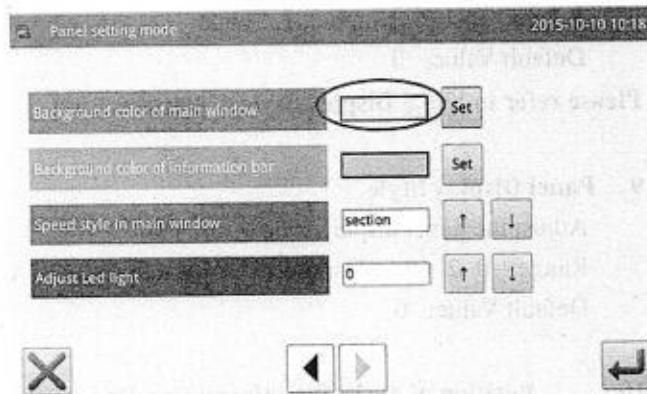

**12. Background Color of Assistant Information Bar**

Set the background color of assistant information bar. The operation is same as above.

**13. Speed Setting in the Main Interface**

The speed can be set by level or by value.

**14. LED Lightness Adjustment**

The adjustment range is 0~100.

### 2.9.6 Back-up Recovery Mode

In function setting interface, press  to enter back-up recovery mode.

User can save the value of changed parameter into the U disk for the parameter recovery in future.

For details, please refer to [2.7.4 Recovery and Back-up of Parameter]

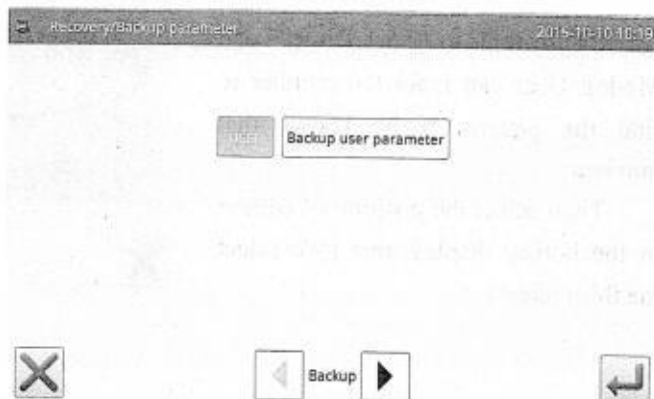

### 2.9.7 Default Parameter Mode

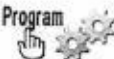
In function setting interface, press  to input the password (the original password is the manufacturer ID). After the input of password, the system will enter Default Parameter Mode.

It is used to recover the default parameters and to save the parameter values for future.

Please refer to [2.7.5 Default Parameter Recovery] for details

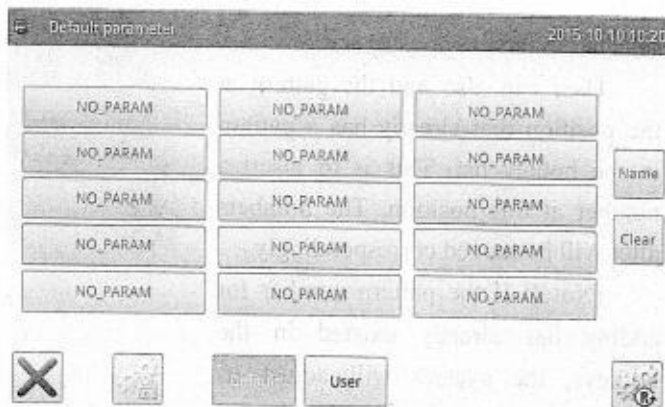

### 2.9.8 Pattern Hotkey Management Mode

In function setting interface, press  to enter Parameter Hotkey Management Mode, where user can edit the pattern number hotkeys.

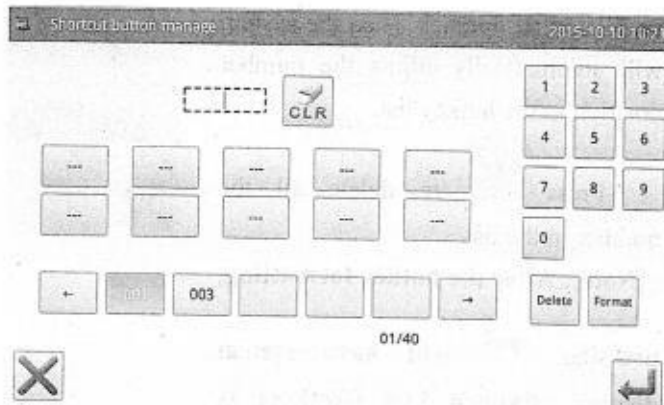

### 1、 Input Pattern Number and Select the Position of Hotkey for Editing

Please refer to [2.5.1 Direct Load Mode]. User can input the number to find the pattern, if he knows that number.

Then select the position of edition in the hotkey display area (We select the third blank)

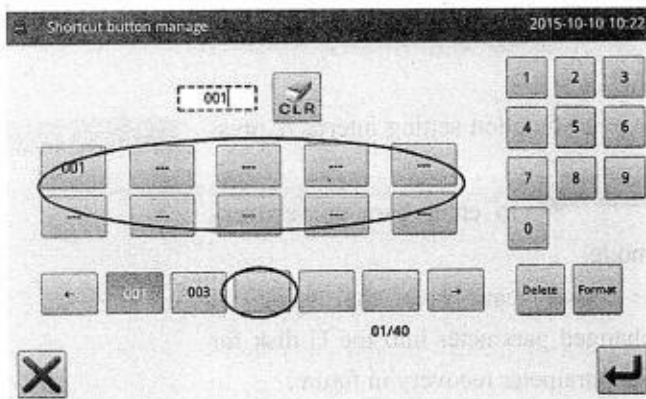

### 2、 Edit the Hotkey

Select a pattern number in the pattern list, then that number will be displayed at the position that we selected in the previous operation.

User can also add the pattern at the position that already has a pattern in the hotkey list. This is to insert a number at this position. The numbers after will be moved correspondingly.

[Note]: If the pattern number for adding has already existed in the hotkeys, the system will adjust its position to the location that is closest to the selected position

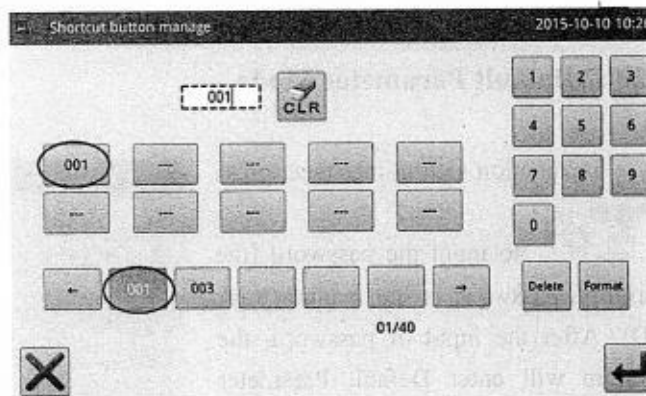

### 3、 Deletion and Formatting

Select a pattern number in the hotkey display area and press  to delete that number. Then the system will automatically adjust the number position in the hotkey list.

Press  to delete all the number in the list.

[Note]: After the hotkey formatting, pressing  will have system display "Pattern List (Hotkey) Is Empty". After confirming the

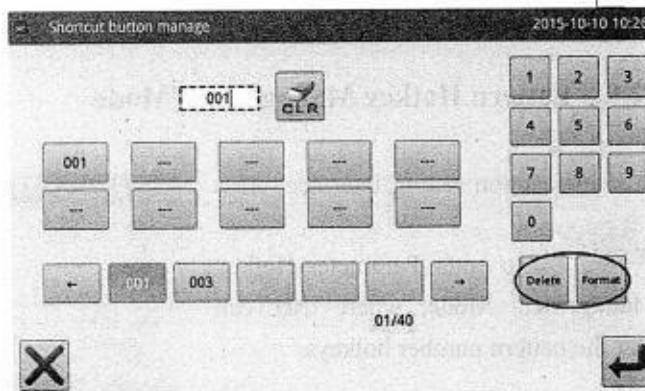

operation the system will automatically load the current pattern number to the hotkey.

## 2.9.9 Password Mode

In function setting interface, press



to activate the interface for inputting the user ID. Input the correct manufacturer ID to enter the password management mode, where user can set and manage the periodical password.

② At most 10 different password action times can be set.

② System can display the password information of the manufacturer.



### 1、Input Board Number

Press “Board Number” to enter the interface for inputting the board number. The board is formed by four figures, the range is from 0000 to 9999. This can be used for the management of the password by the manufacturer. After inputting the board number, user

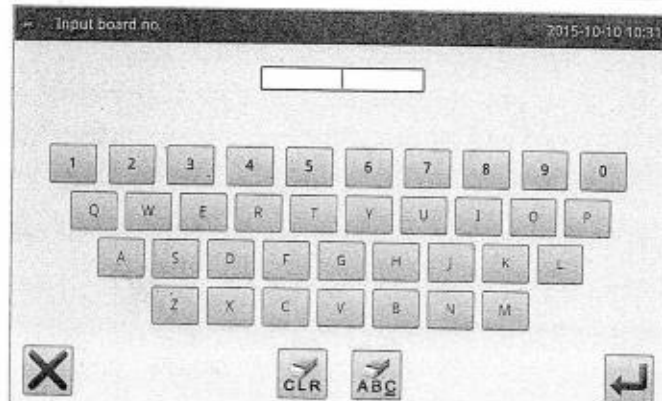
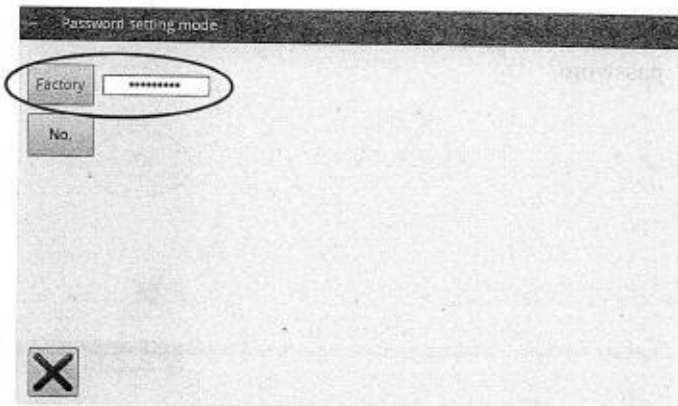
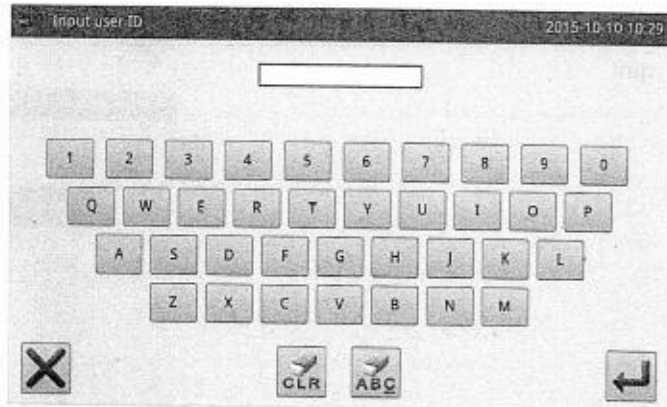
can press  to finish the operation and return to the previous interface. (Here, we input 0001 as the board number).



### 2、 Confirm the System Clock

Press “Clock” to enter the interface for setting system time and date. For changing the system clock, user need press  after the modification (Refer to [2.9.14 Date and Time Setting Mode]), or press  to quit.

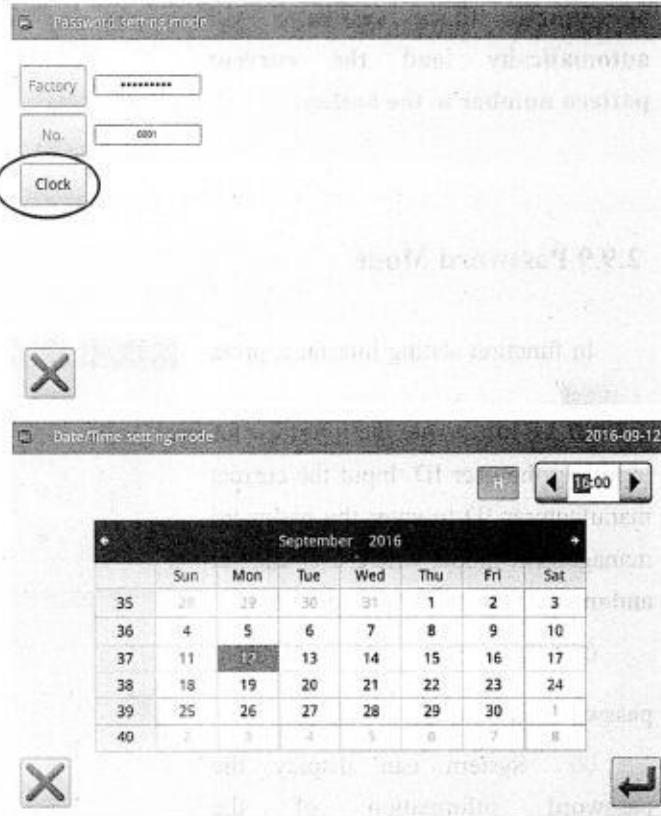

### 3、 Input the Super Password

Press “Super Password” to enter the interface for inputting the super password.

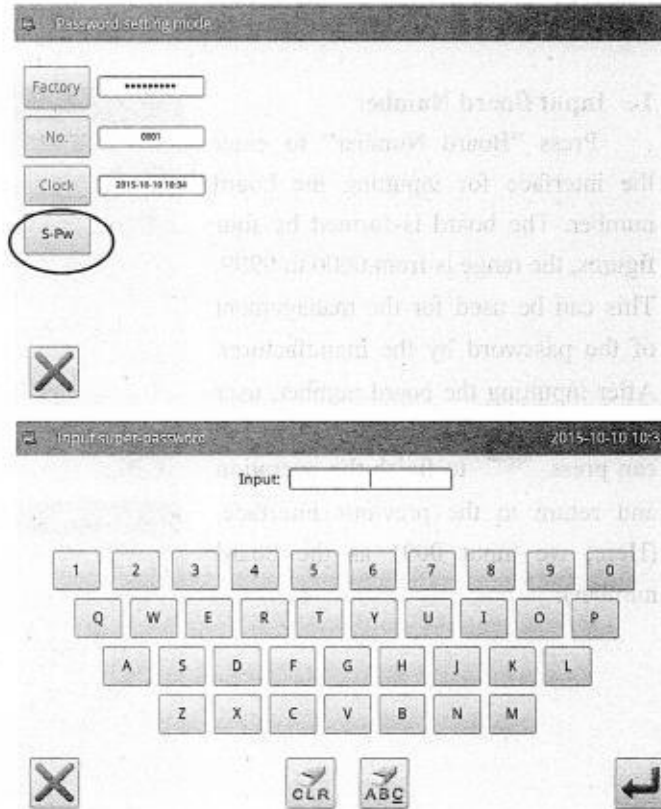

At most 9 figures can be inputted, which are displayed as “•”. After user presses , the system will ask user to input that password again for confirmation.

If the inputted passwords in these two times are different, the system will ask user to input the super password again. After these two inputted passwords

agree, user can press  to save it and quit.

#### 4、Input Activation Time and Periodical Password

Press “pw-1” to input the first activation date.

The activation date is the first time when the password is activated. This date shall be later than the system date.

Select the proper date and press

 to finish the operation. At this moment, the system will turn to password input interface

The input method of the periodical password is the same as that of the super password. After the confirmation, press  to quit.

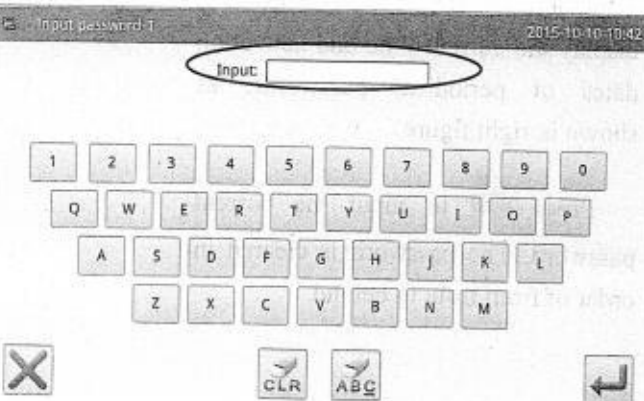
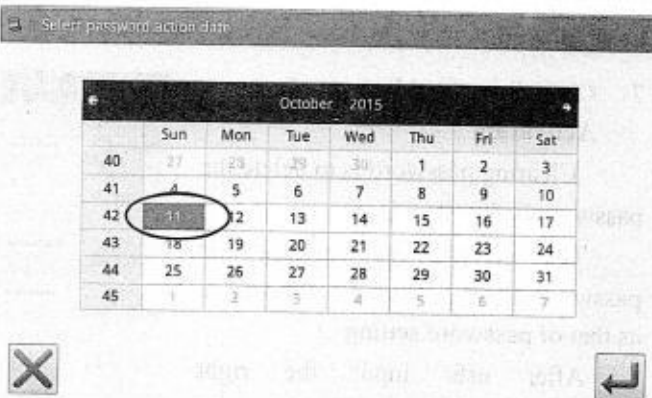
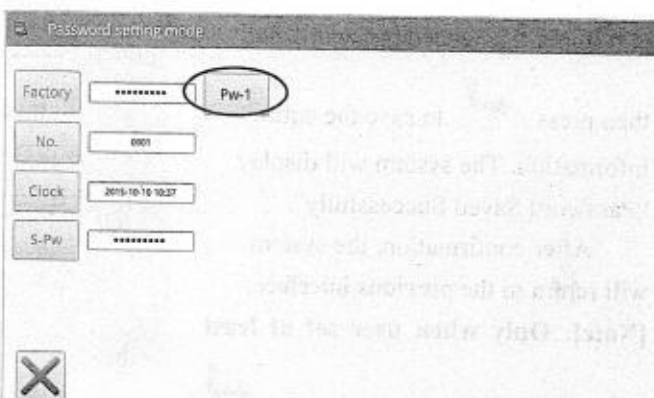
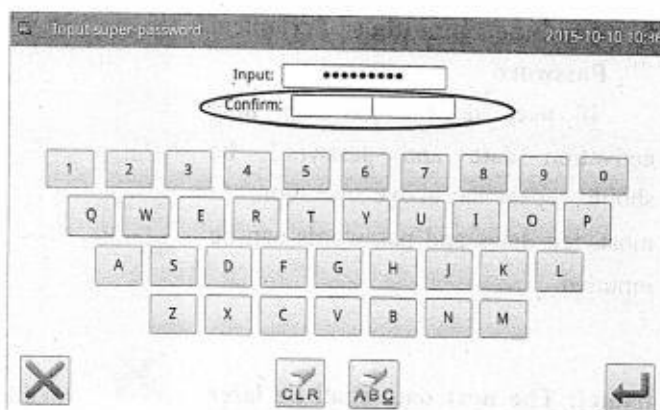

### 5. Continue Inputting Periodical Password

If user need input the next activation date and password, he should repeat the above operation. At most, ten dates and passwords can be inputted.

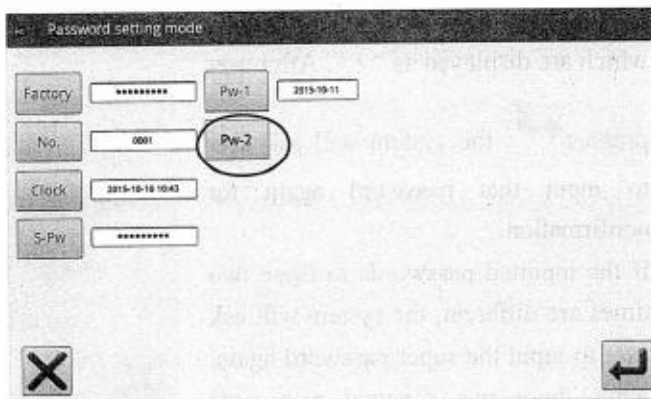

**[Note]:** The next date shall be later than the previous one.

### 6. Save Password

Input the needed password, and then press  to save the entire information. The system will display "Password Saved Successfully".

After confirmation, the system will return to the previous interface.

**[Note]:** Only when user set at least one periodical password, can  be displayed.

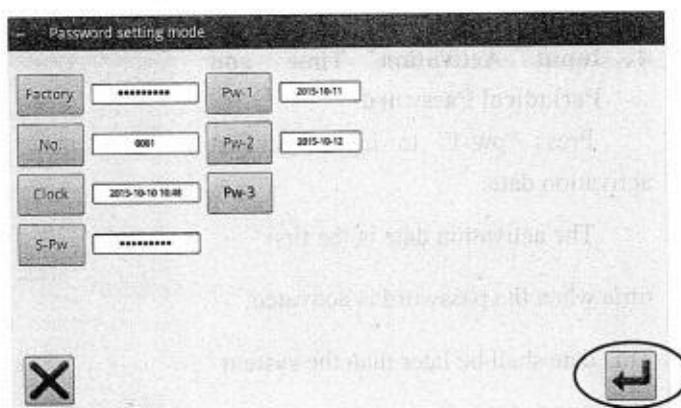

### 7. Clear Password before Activation

Clearing password is to delete the password before it activates.

The method for entering the password display interface is the same as that of password setting

After user input the right manufacturer ID, the system will display the current time and activation dates of periodical passwords, as shown in right figure

Press  to input the current password. The password is cleared in order of from front to behind.

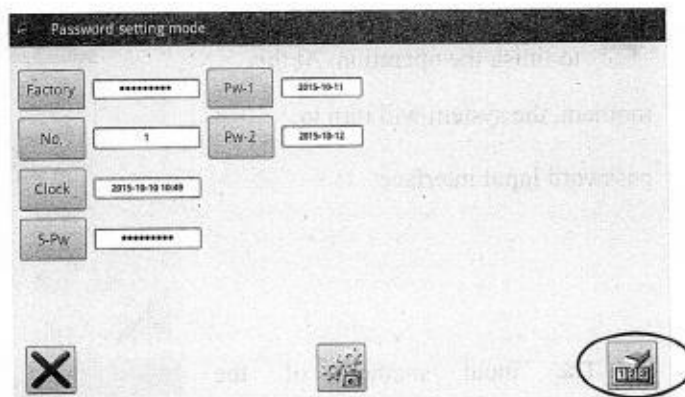

At this moment, user can input two passwords. If the inputted password is the current password, the current password will be deleted. If the super password is inputted, the entire password will be deleted. If the current password is deleted and the current password is the last password, the system will have no password any

more. Press  to finish the operation.

The deleted password will display in red color as shown in the right picture. If the entire password is deleted, the system will return to the upper level interface.

### 8. Clear Password at Activation

If the system has the password and that password is not canceled, the password will activate at the set date. At this moment, user has to input the effective password to have the machine continue to work normally.

The effective passwords include the current password and the super password. If the inputted password is the current password, the current password will be deleted. If the super password is inputted, the entire password will be deleted. If the password is current password and the current password is the last password, the system will have no password any more. If the machine still have other password other than the current password, the next password will activate according to the set date

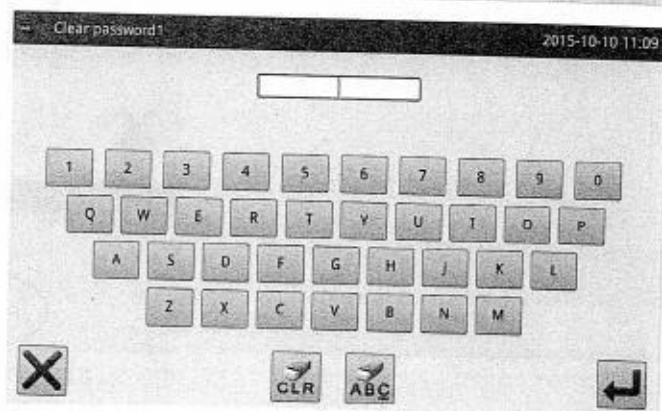
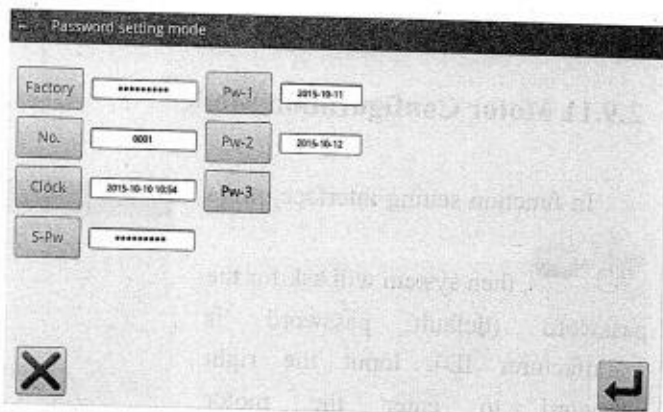
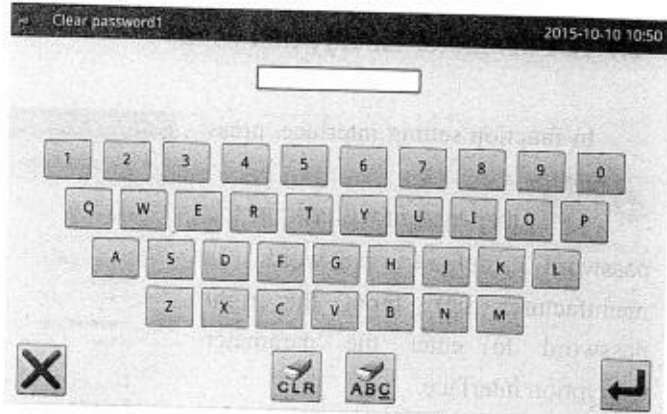

### 2.9.10 Parameter Encryption Mode

In function setting interface, press  , then system will ask for the password (default password is manufacturer ID). Input the right password to enter the parameter encryption interface.

For details, please refer to [2.7.3 Parameter Encryption]

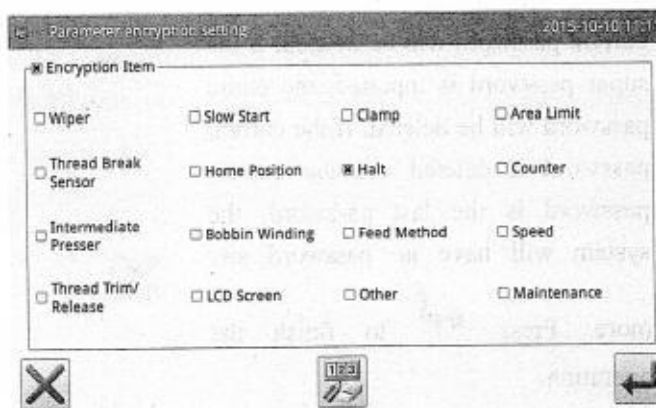

### 2.9.11 Motor Configuration Mode

In function setting interface, press  , then system will ask for the password (default password is manufacturer ID). Input the right password to enter the motor configuration interface.

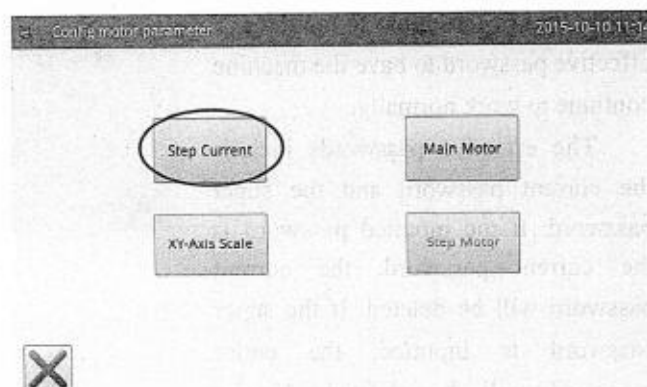
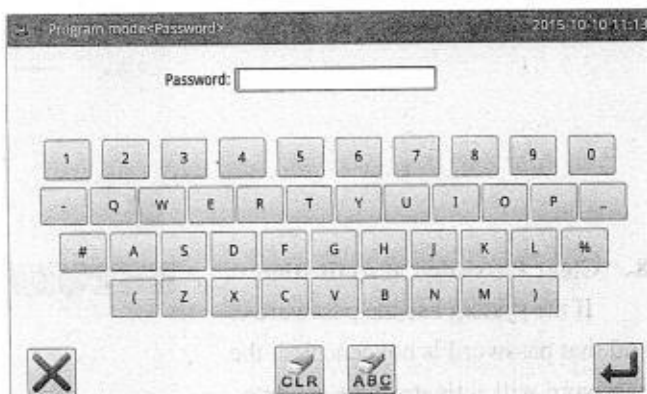



**Example:**

Press the “Main Motor” to enter the main motor configuration parameter interface.

We can see all the parameters are displayed in forms. Clicking any grid will display the arrow for adjusting the parameter value. No arrow means the parameter can not be set.

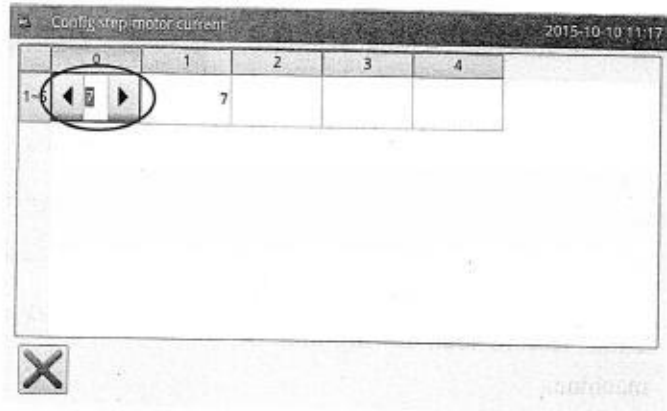
Set the parameter and then click the area beyond the grid to save that parameter value. (Here, we changed No.1 parameter. After the modification, we need click at the area pointed by arrow to save the value)

**2.9.12 Alarm Record Mode**

In function setting interface, press , then system will ask for the manufacturer ID. After user gives the right ID, the system will enter the alarm record mode

In this mode, the current alarm will be recorded. The smaller number means the later alarm.

It also records the accumulated production value at each alarm.

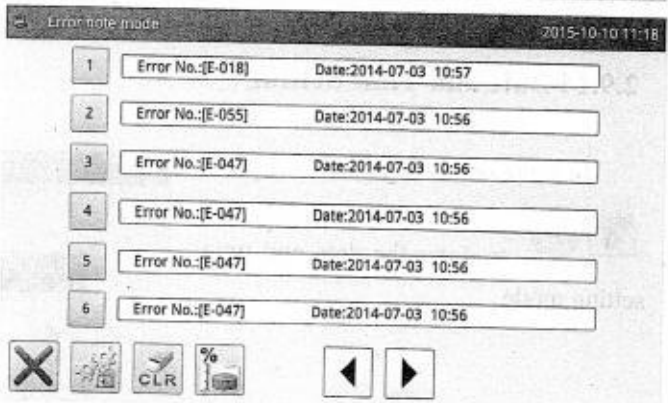
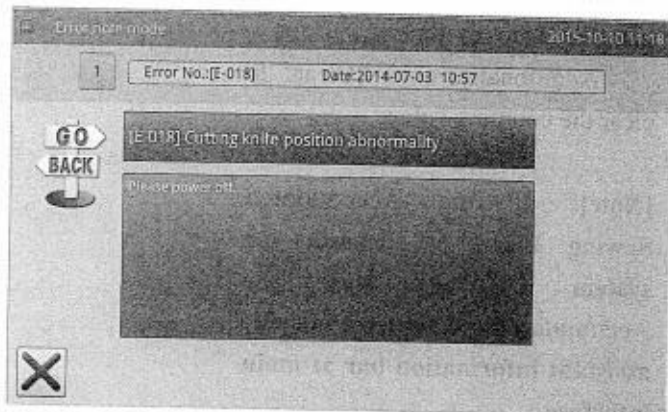

Click each number, and the information of and solution for the error will be displayed.

### 2.9.13 Running Records Mode

In function setting interface, press , then system will ask for the manufacturer ID. After user gives the right ID, the system will Enter the running record mode.

① Accumulated Running Time: Record total sewing time of machine.

② Accumulated Sewing Pieces: Record the total number of the sewn patterns.

③ Accumulated Power-on Time: Record the total time of power-on

④ Accumulated Stitch Number: Record the total stitch number of the machine.

Additionally, click "Clear" to clear the counting value.

**[Note]: If the Accumulated Sewing Pieces is cleared, the system will also clear the Accumulated Counter in the assistant information bar at main interface.**

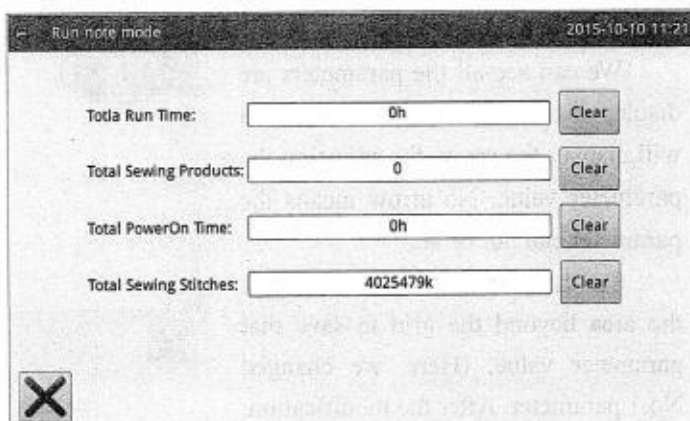

### 2.9.14 Date and Time Setting

In function setting interface, press  to enter the date and time setting mode.

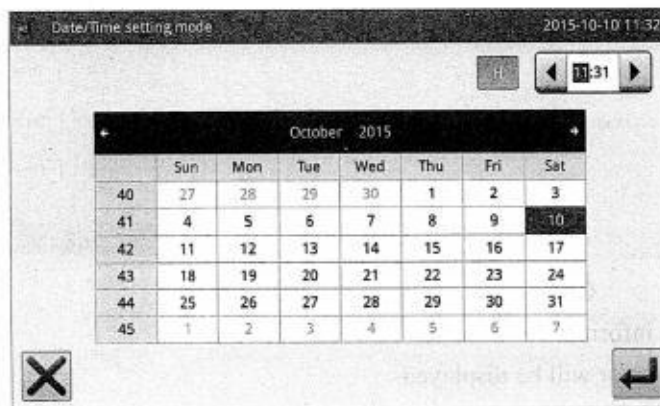

## 12. Method for Setting Date

Click "Year" (Here, it is 2011) to display two arrows to adjust it

Click "Month" (Here, it is June) to display the list of months. User can select the proper month.

After the setting, the display of year and month will be refreshed to the right ones.

User can also use  & 

to check the content in calendar.

Click the day to complete the setting.

**[Note]: User has to set year, month and date to finish the setting. Only setting the year and month will not complete this operation.**

## 13. Method for Setting Time

In default, user has to set hour first. Press "hour" to shift the setting to minute (Pressing "hour" is to change it to "minute") and then press the arrows to change the time.

User can also click the display area to shift between hour and minute.



After the setting of date and time, please press  to save it.

## 14. Forbid to Change System Time

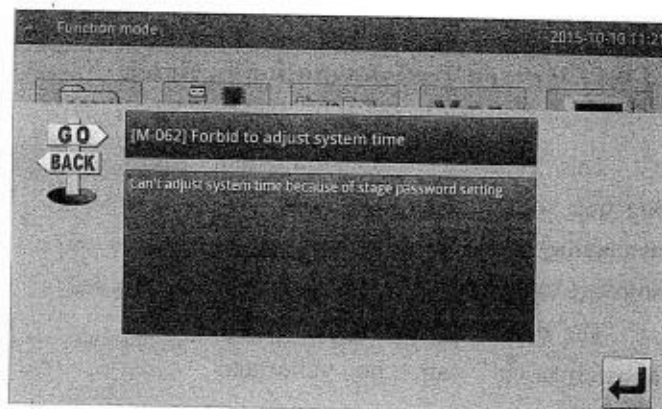
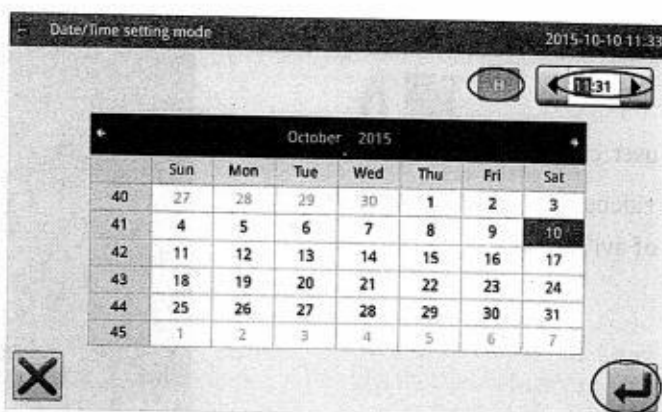
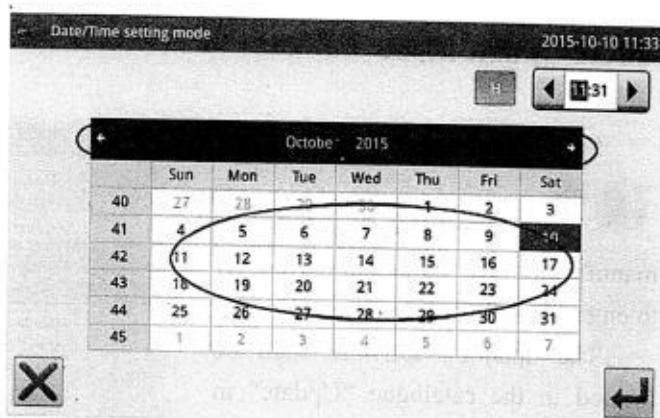
Once the machine is set with the periodical passwords, the system will deny the change on the system time. After all the passwords are cleared, the system will unlock the setting of the system time.



### 2.9.15 Update Mode

In function setting interface, press  . The system will ask for the manufacturer ID. Input the correct ID to enter the software update mode.

The updating software shall be located in the catalogue "Update" in the U disk.

Click the content for update (the content in shadow is the selected), then press .

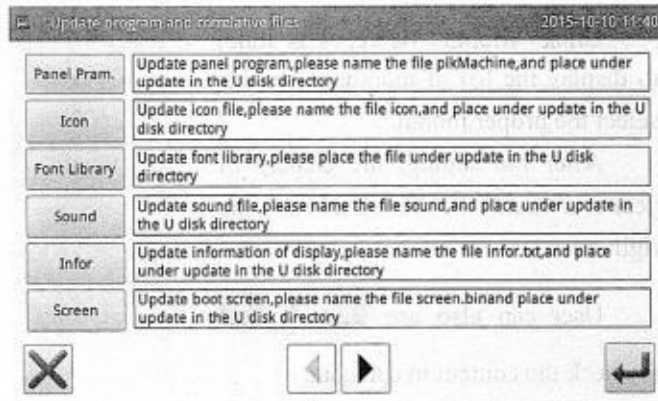

### 2.9.16 Player

In function setting interface, user can press  to play videos and audios. Videos shall be of avi format.

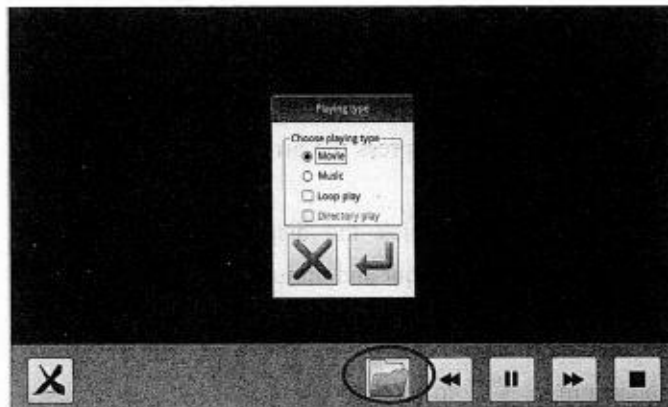

### 2.9.17 Pattern Transformation in Batch

This batch transformation function can enable the continual availability of the patterns after software update.

The default pattern number after transformation can be allocated manually.

The default setting is to select all patterns, and pattern names marked with x are selected.

The original patterns will be deleted. If you want to keep them,



please select Keep Original Patterns at the bottom.

### 2.9.18 Hotkey Setting

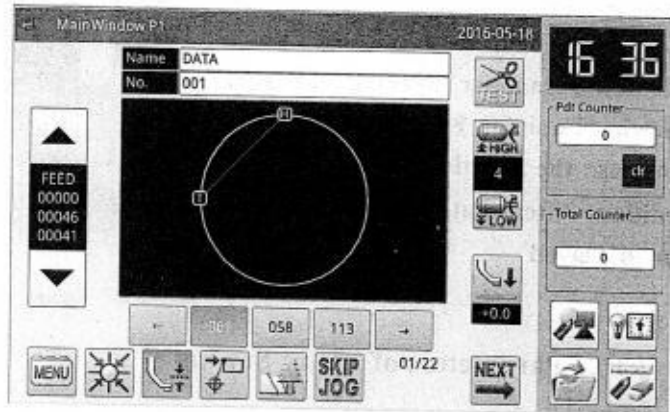

Hotkey function is used to set the four function keys at the lower right corner according to the user's habits.

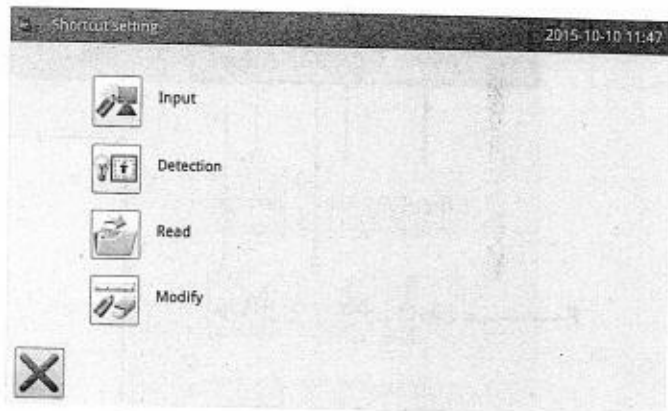

Press  to enter hotkey function setting interface. User can set these four commonly used functions respectively: pattern-making, test mode, pattern loading, and pattern modification.



#### Pattern-making setting:

Press  to enter pattern-making hotkey setting. After selecting \*图形排版, press  to save and quit.

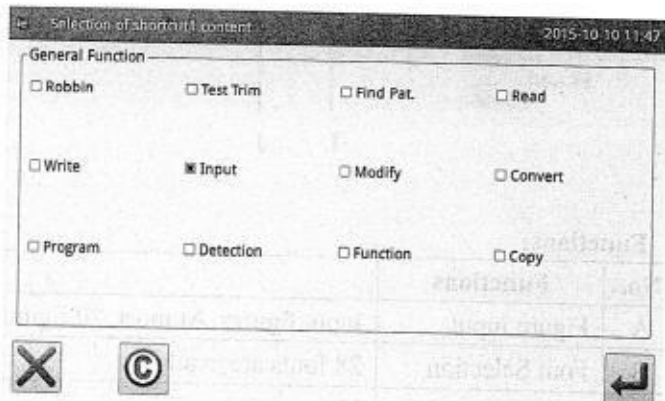

### 2.10 Letter Sewing Edition

In main interface P1 (or P2), press



to activate the catalogue mode,

and then press **ABC** to enter letter sewing edition mode.

[Note]: Parameter [Special] -> [Letter Sewing Function Enable] can be used to close the function of letter sewing edition. After that, this icon will not be displayed

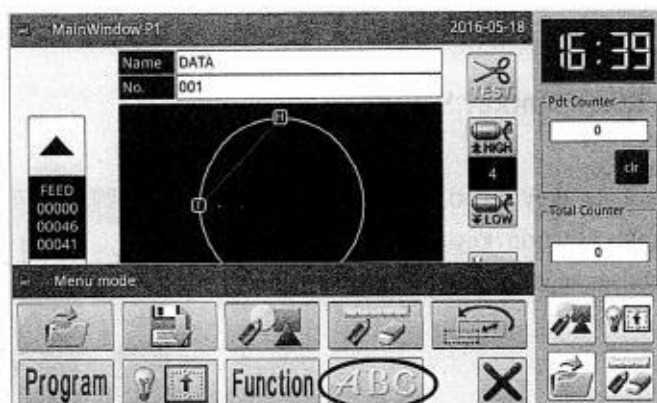

#### 2.10.1 Parameters of Letter Sewing

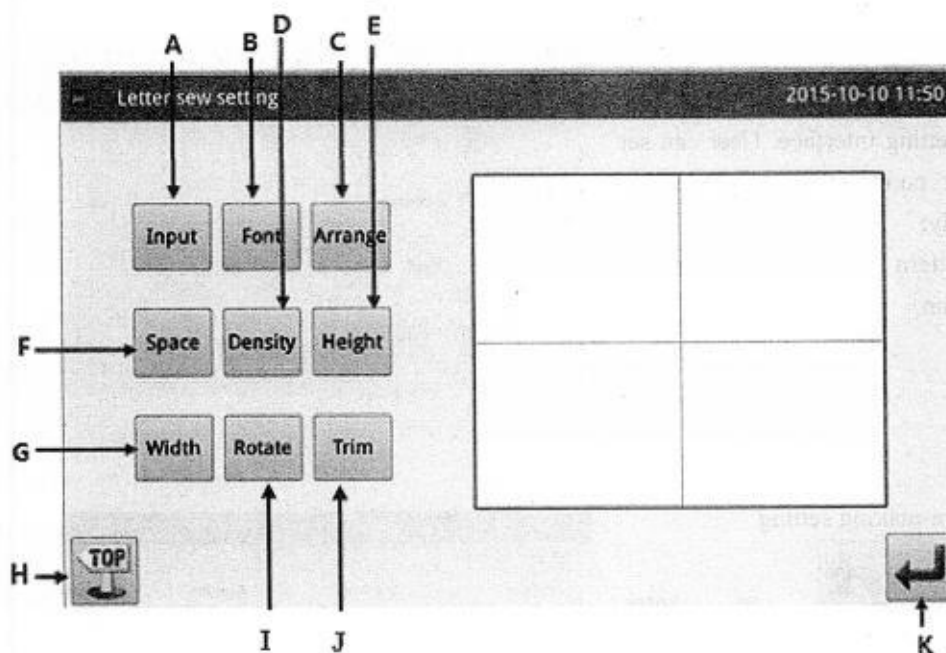

**Functions:**

No.	Functions	Content
A	Figure Input	Input figures. At most, 20 figures can be inputted
B	Font Selection	28 fonts are available.
C	Array Method	User can select "Horizontal", "Vertical", "Upper Arc" "Down Arc"
D	Density of Satin	Set the satin density. The larger value means the denser satin stitches
E	Scaling in Height	Scale the height of letter, range: 50~200.
F	Letter Pitch	Set the interval between letters
G	Scaling in Width	Scale the width of letter, range: 50~200.
H	Return	Quit and return to main interface

I	Rotation/Follow (Not Follow)	When the array method is linear (vertical or horizontal), the content on the button will be displayed as "Rotation", which is to set the rotation angle of letter; When the array method is arc (Upper Arc or Down Arc), this button will display "Follow" or "Not Follow", which is to set whether the letter rotates with the arc.
J	Trim/Not Trim	Set whether to automatically insert thread-trimming code
K	Enter	Confirm operations. And then enter pattern adjustment interface.

### 1、 Figure input

Press "Input" to enter figure input interface, where user have to input at least one figure. 20 figures can be inputted at most.

Press  to save the input and quit.

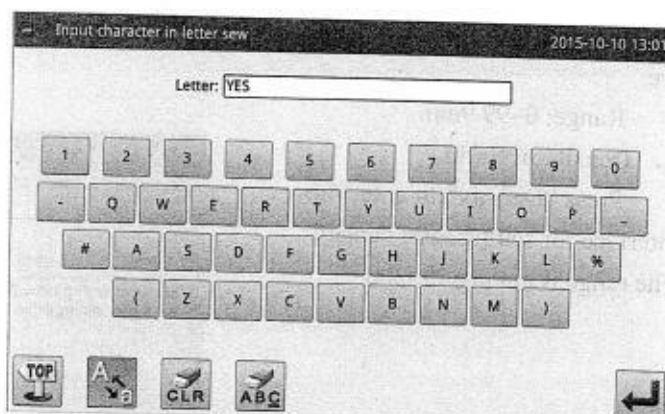

### 2、 Font Selection

Press "Font" to enter font selection interface, where 28 types of fonts are provided. Input the numbers from 1 to 28

to select the font. Press  to save it and quit.

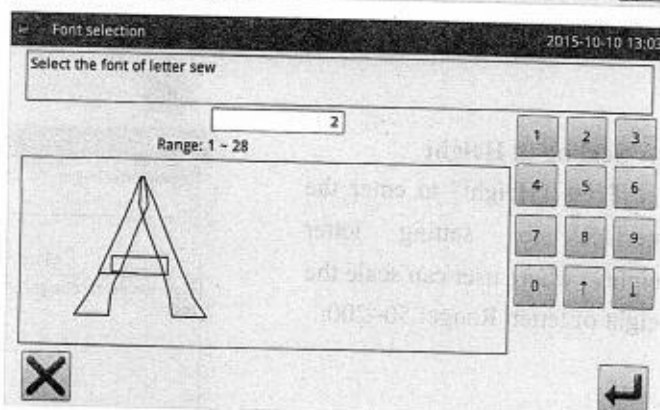

In this interface, the font will be displayed to users.

### 3、 Array Method

Press "Array" to enter the interface for setting array method, where user can select horizontal linear, vertical linear, upper arc and down arc. Press

 to save it and quit.

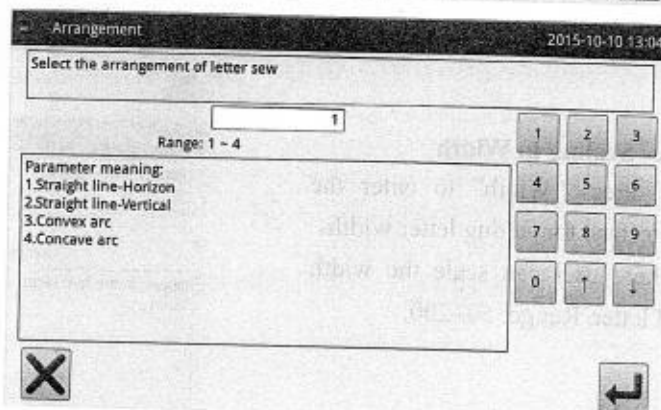

#### 4、 Figure Pitch

Press “Pitch” to enter the letter pitch setting interface.

In horizontal array, it is to set the horizontal pitch between letters.

In vertical array, it is to set the vertical pitch between letters.

In arc array, it is to set the distance between the letters on arc.

Range: 0~99.9mm.

#### 5、 Density of Satin

Press “Density” to enter the interface for setting satin density. The range is among 50~200.

#### 6、 Scaling in Height

Press “Height” to enter the interface for setting letter height, where user can scale the height of letter. Range: 50~200.

#### 7、 Scaling in Width

Press “Width” to enter the interface for setting letter width, where user can scale the width of letter. Range: 50~200.

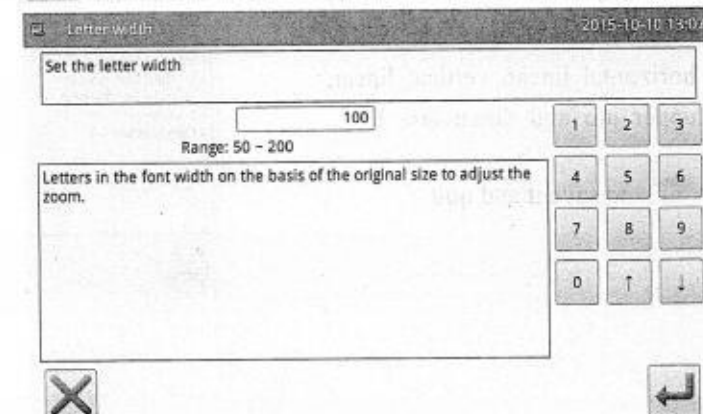
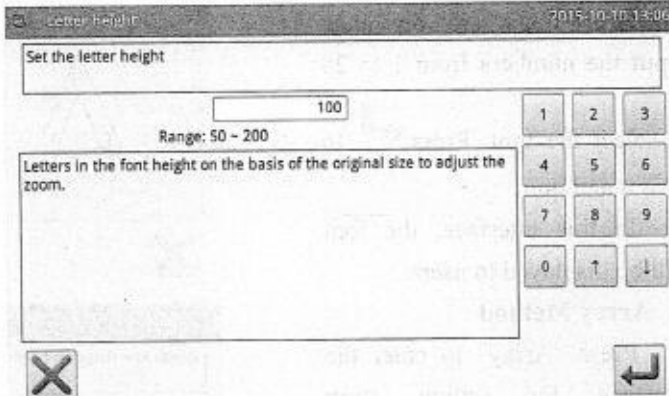
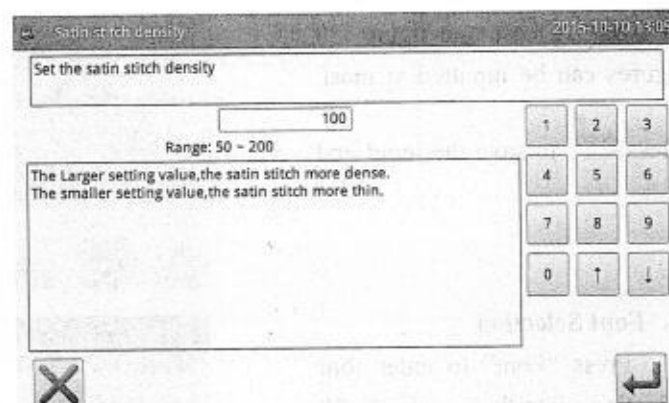
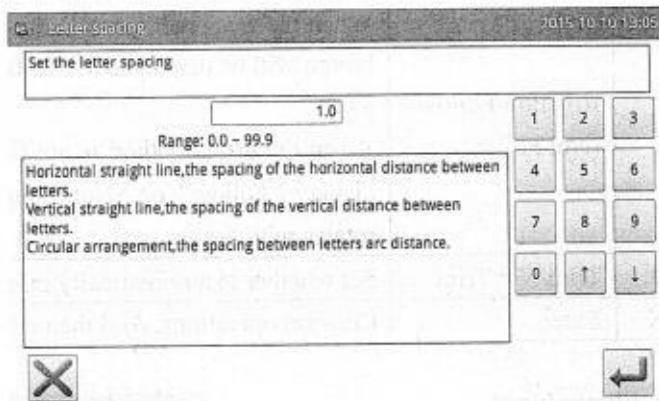

### 8、 Rotation Angle Setting

When the array method is set at "Horizontal" or "Vertical", user can set the rotation angle of the letter. Press the "Rotation" to enter the interface for setting rotation angle.

The rotating direction is counter-clockwise. Range: 0°~359°.

**[Note]:** When the array method is arc (Upper Arc or Down Arc), this button is to set whether the letter rotates with the arc.

### 9、 Follow/Not Follow

When the array method is arc (Upper Arc or Down Arc), user can set whether the letter rotates with the arc. Press "Follow" to shift it to "Not Follow", vice versa.

**[Note]:** when the array method is "Horizontal" or "Vertical", this button is to set the rotating angle.

### 10、 Add Auto-Trimming

In default setting, the system will add auto-trimming, which is to add trimming code at the end of sewing, joint of empty feeding (or sewing).

Press "Trim" to change the content on button and cancel the function for automatically adding trimming functions.

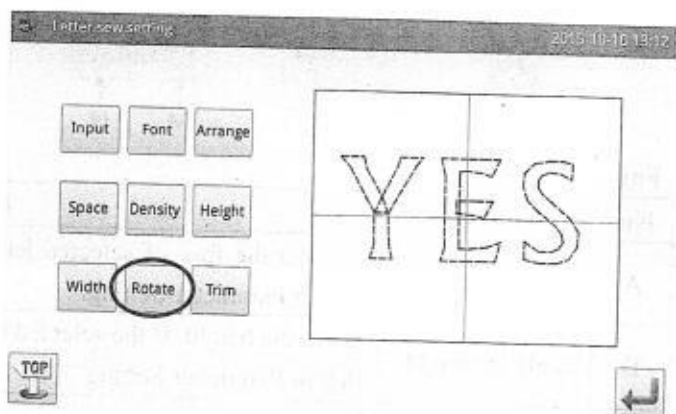
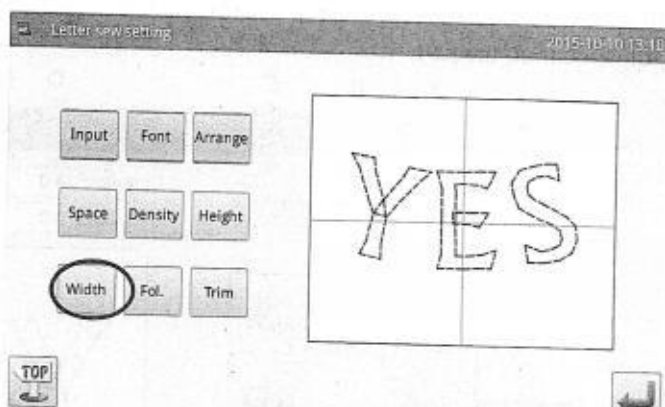
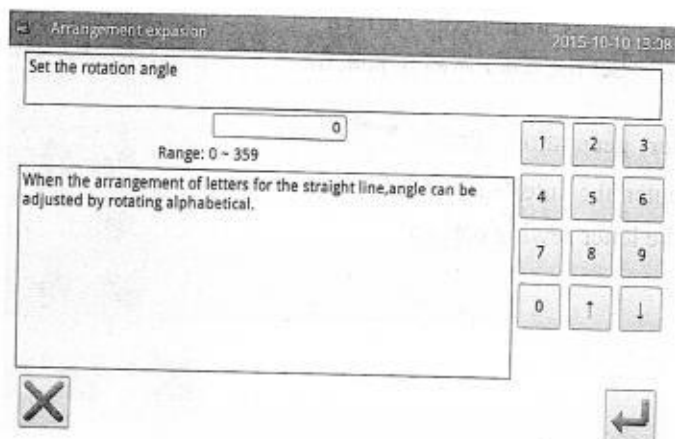

### 11. Confirm the Pattern

Set the letter sewing pattern

for generation. Press  to enter the interface for adjusting the letter sewing pattern.

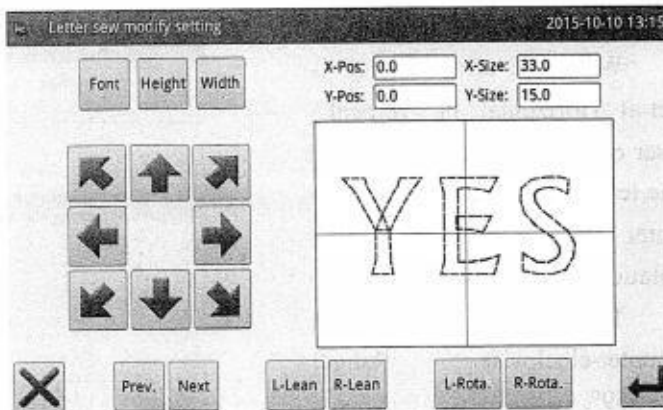

### 2.10.2 Adjustment of Letter Sewing Pattern

In the interface for setting parameters of the letter sewing, user can press  to enter the interface for adjusting the letter sewing pattern. In this interface, user can have the further adjustment on the pattern.

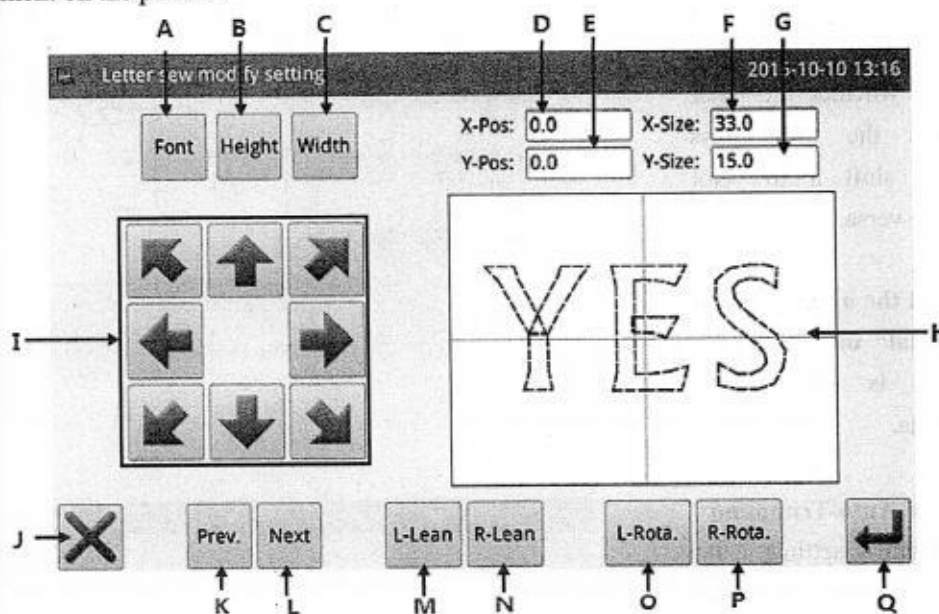

**Functions:**

No.	Functions	Content
A	Font Selection	Change the font of selected letter. The setting method is the same as that in Parameter Setting.
B	Scale in Height	Scale the height of the selected letter. The setting method is the same as that in Parameter Setting.
C	Scale in Width	Scale the width of the selected letter. The setting method is the same as that in Parameter Setting.
D	X Position	Display the X coordinate of center point of the selected letter
E	Y Position	Display the Y coordinate of center point of the selected letter
F	X Size	Display the width of the selected letter
G	Y Size	Display the height of the selected letter

H	Pattern Display	Display the current pattern for letter sewing. The selected letters are displayed in red; the unselected letter is displayed in green.
I	Direction Key	Adjust the position of the selected letter.
J	Esc	Return to the previous interface
K	Previous Letter (from right to left)	Select the letter for adjustment from right to left. The selected figure is displayed in red. When the icon still goes to left at selecting the last letter, the entire letters will be selected.
L	Next Letter (from left to right)	Select the letter for adjustment from left to right. The selected figure is displayed in red. When the icon still goes to right at selecting the last letter, the entire letters will be selected.
M	Left Tilt/Radian Down	When the array method is horizontal array or the vertical array, this button will display "Left Tilt". Pressing this button will rotate the entire pattern counterclockwise in the center of origin When the array method is arc, this button will display "Radian Down". Pressing this button will reduce the radian of entire pattern. [Note] This operation is for the entire pattern.
N	Right Tilt/Radian Up	When the array method is horizontal array or the vertical array, this button will display "Right Tilt". Pressing this button will rotate the entire pattern clockwise in the center of origin When the array method is arc, this button will display "Radian Up". Pressing this button will increase the radian of entire pattern. [Note] This operation is for the entire pattern.
O	Left Rotation	Adjust the rotating angle of the selected letter counterclockwise. The rotation center is the center of the letter
P	Right Rotation	Adjust the rotating angle of the selected letter clockwise. The rotation center is the center of the letter
Q	Enter	Press it to Enter the pattern save interface

**Example:****1. Select Single Letter for Adjustment**

Press "Previous Letter" or "Next Letter" to select the single letter for adjustment. The selected letter is displayed in red, while the unselected are displayed in green

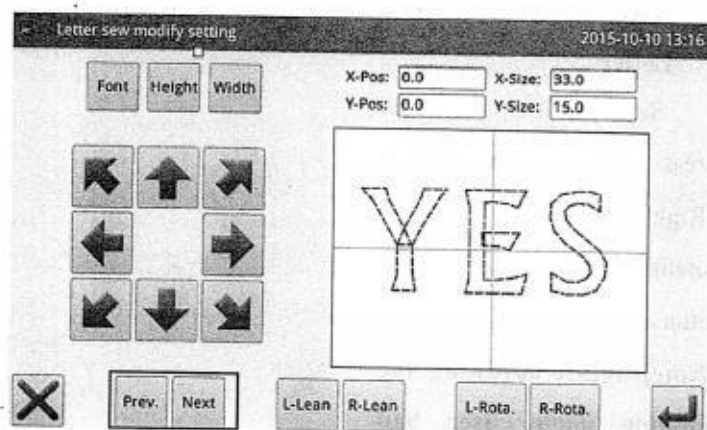

**2、 Letter Position Adjustment**

Press direction keys to adjust the position of the selected letter. User can see the coordinates from “X Position” and “Y Position”

With the same operations, user can adjust the position of other letters.

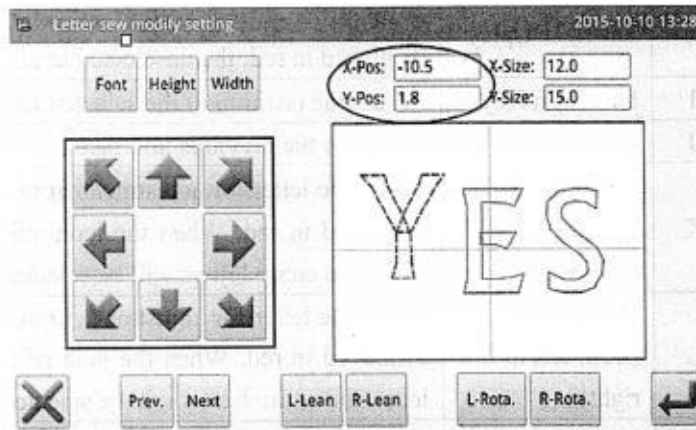

**3、 Adjust the Rotating Angle of Entire Pattern**

Press “Left Tilt” or “Right Tilt” to adjust the rotating angle of the entire pattern

“Left Tilt”:

Counter-clockwise Rotation

“Right Tilt”: Clockwise Rotation

[Note]: When the array method is arc, these buttons will turn to “Radian Up”/ “Radian Down”, which are to adjust the radian of the entire pattern

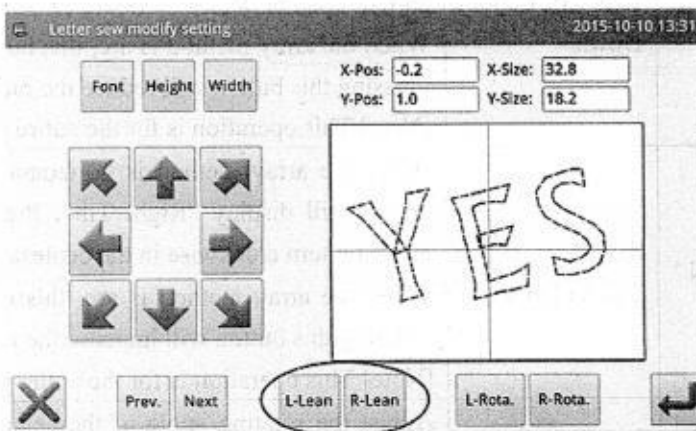

**4、 Rotation of Single Letter**

Select a letter and then press “Left Rotation” or “Right Rotation” to adjust the rotating angle of the selected letter

[Note] When adjusting the rotating angle, user had better adjust the rotating angle of the entire pattern at first. If user adjust the

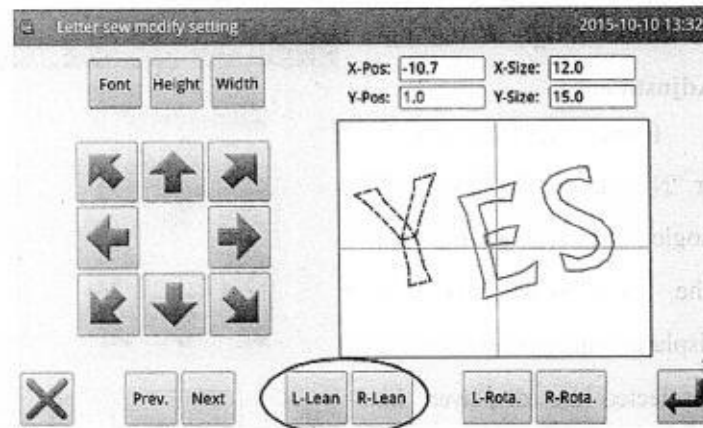

rotating angle of the single letter at first, the adjustment will be canceled when user rotates the entire pattern.

### 5、 Save Pattern

After the adjustment, press  to enter interface for saving patterns.

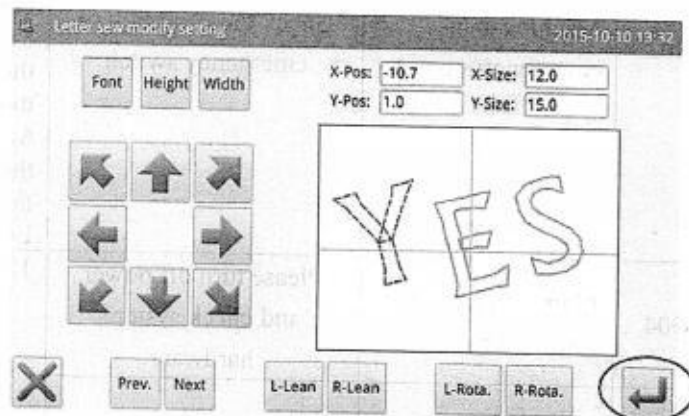

Input name and number, and then press . The system will display "Letter Sewing Pattern Saved Successfully". (For other operations, please refer to [2.6 Save Pattern].)

[Note] After the successful saving, the letter sewing pattern will not turn to current pattern automatically. User has to enter the pattern loading interface to select it.

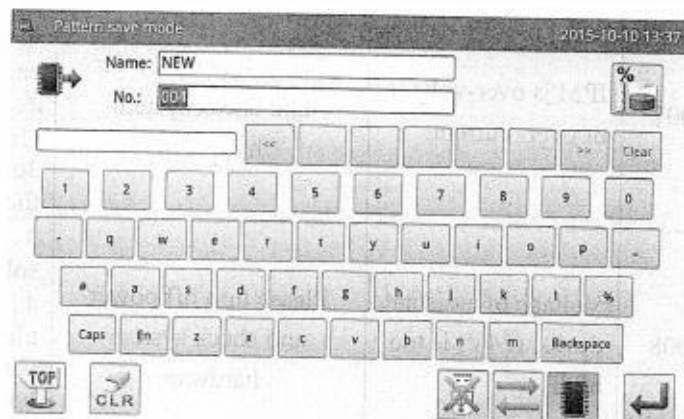

## 3 Appendix 1

### 3.1 Warning Information List

Number	Name of Malfunction	Sub-information Content	Solution
E-001	Pedal not at normal position	Please adjust pedal position	
E-002	Machine is in emergency stop	Check the condition of emergency switch	Turn and release the emergency button. If the screen keep displaying this hint, please check in the following way: 4、 Check the condition of emergency button. 5、 Check the connection between the emergency button and head transfer board. 6、 Check the connection between the X9 terminal on cable L433 and the head transfer board. Open cable L433 to seek breakage.
E-004	Main voltage is too low (300V)	Please turn off power and check system hardware	1. Check if the AC power supply has abnormal fluctuation; Make sure there is no high-power device that is turned on/off frequently; equip the voltage regulator. 2. If the AC power supply is normal, the problem may be at the hardware. Please return the main control board for repair.
E-005	Main voltage is too high (300V)	No	
E-007	IPM is over-voltage or over-current	Please turn off power and check system hardware	3、 Make sure no short circuit at main motor; check if the value of each winding is equal and not 0; 4、 Check whether the output at U\V\W is shorted out to earth or the 300V power supply, so as to judge the condition of IPM.
E-008	Voltage of assistant device (24V) is too high	Please turn off power and check system hardware	3、 Check if the peripheral solenoids and valves are shorted. 4、 Make sure the cores in both plugs on L478 cable are not shorted. Check whether the head transfer board is shorted out to head at installation
E-009	Voltage of assistant device (24V) is too low	Please turn off power and check system hardware	5、 Check if the peripheral solenoids and valves are damaged 6、 Check whether cores in both plugs on L478 (For Hai Ling, it is L432) cable are shorted. 7、 Check whether the head transfer board is shorted to head at

Number	Name of Malfunction	Sub-information Content	Solution
			installation. 8. Check the power part at the main control board; check the pin on CPU for collecting 24V power signal
E-010	Valve (Fan) has problem	Please turn off power and check system hardware	1. Check whether the power of fan has problem 2. Check the condition of 24V for head board 3. Search short connecting at peripheral valve
E-013	Encoder is error or unconnected.	Please turn off power and check system hardware	1. Turn off the machine and check the connection between the encoder cable and the plug at control box.
E-014	Motor running abnormal	Please turn off power and check system hardware	6. Check whether the main shaft is blocked by the load. 7. Turn the hand wheel and repower the machine when the main shaft is at another angle. 8. Motor reply signal error, replace motor
E-015	Exceeds sewing area	Please press Enter.	1. Pattern data process is abnormal. Re-pick the pattern and search the origin for sewing again. Make sure the problem is at pattern or caused by BUG in software. 2. Check whether the sewing range set in operation head matches to the selected pattern.
E-016	Needle bar Upper position abnormal	Please press Enter.	Turn the hand wheel to lift the needle bar to the upper position of the upper dead point, and then step the pedal.
E-017	Thread breakage detection error	Please press Enter.	Check CZ424 port on head transfer board and cable L433.
E-018	Trimmer position abnormal	Please turn off power.	
E-019	Emergency switch is not at the right position	Check the condition of emergency switch.	1. It is common hint, not the problem. Please release the emergency switch. 2. Refer to the solution in EB002
E-020	Stepping software version error	Please turn off power.	
E-023	Thread-catching position abnormal	Please turn off power.	
E-024	Wrong connection between operation head and sewing machine	Please turn off power.	

Number	Name of Malfunction	Sub-information Content	Solution
E-025	X origin detection abnormal	Please turn off power.	7、 Use debugging function to move the frame manually and test whether the coupler signal is displayed; 8、 When the machine is on, user can use a piece of metal sheet to approach the proximity switch. This is to test whether the system can give the vocal warning. 9、 Adjust the installation position of the proximity switch to ensure its reliable actions. 10、 Test the working condition of the stepping motor and make sure they have no step missed; 11、 Test the conditions of the stepping cables and sensor cables 12、 Check the connection of L433 cable, make sure this cable has no short or breakage at the connectors at both ends
E-026	Y origin detection abnormal	Please turn off power.	
E-027	Presser origin detection abnormal	Please turn off power.	
E-028	Thread-catching origin detection abnormal	Please turn off power.	
E-029	Intermediate presser origin detection abnormal	Please turn off power.	
E-030	Stepping driver communication abnormal	Please turn off power.	3、 Check the connection of cable between the main control board and the stepping board 4、 Make sure the stepping board power is normal or not. Ensure the power indicator and the working indicator are sparking normally
E-031	Stepping motor over-current	Please turn off power.	3、 The stepping motor is broken; user needs to replace the stepping motor 4、 The stepping drive board is broken; user needs to replace the stepping drive board
E-032	Stepping driver power abnormal	Please turn off power.	
E-034	Abnormal current	Please turn off power.	6、 Turn off the power. Turn the hand wheel to test the running of the main shaft. Check whether any mechanism is blocked. 7、 Turn off the power. Check the connection at the coupling of the main shaft motor. The large interval at the coupling will cause the over-current at the motor 8、 Turn off the power. Measure whether the resistance values at the three-phase resistance are equal. If not, the motor is down. 9、 Turn off the power. Use the multimeter to test the IPM module, if IPM is down, please do not repower the machine. User needs to
E-035	IPM over current frequently 1	Please turn off power.	
E-036	IPM over current frequently 2	Please turn off power.	

Number	Name of Malfunction	Sub-information Content	Solution
			<p>replace or repair it.</p> <p>10、 When the system gives warning, please make sure whether the machine is at the process of trimming or stop. If so, please adjust the main shaft parameters to solve this problem.</p>
E-037	Motor is blocked 1	Please turn off power.	<p>6、 Due to the wrong location of the main shaft angle, the trimmer is jammed on the needle when cutting the thread, thus causes the main shaft to be blocked. Solution: Relocate the main shaft angle</p> <p>7、 The needle rod is jammed on the intermediate presser at moving, which causes the blockage of the main shaft. Solution: check the action of the intermediate presser and the connection between the air valve and the solenoid valve.</p> <p>8、 The trimmer can't cut the thread due to lacking of strength, which causes the blockage of the main shaft. Solution: adjust the main shaft parameter and increase the strength of trimming.</p> <p>9、 The mechanism has dead point, so the main shaft is blocked. Solution: adjust the mechanism;</p> <p>10、 The encoder at the main shaft motor has problem, which responses the wrong signal, thus causes the blockage of the motor. Solution: replace the main shaft motor</p>
E-038	Motor is blocked 2	Please turn off power.	<p>5、 The used fabric is too thick to be penetrated by the needle. Solution: adjust the main shaft parameters or change to a motor with larger power capacity;</p> <p>6、 The needle rod is jammed on the intermediate presser at moving, which causes the blockage of the main shaft. Solution: check the action of the intermediate presser and the connection between the air valve and the solenoid valve</p> <p>7、 The mechanism has dead point, so the main shaft is blocked. Solution: adjust the mechanism</p> <p>8、 The encoder at the main shaft motor has problem, which responses the wrong signal, thus causes the blockage of the motor. Solution:</p>

Number	Name of Malfunction	Sub-information Content	Solution
			replace the main shaft motor
E-039	Motor over speed	Please turn off power.	
E-040	Over current in stop status	Please turn off power.	
E-041	Motor overload	Please turn off power.	
E-042	Bus voltage abnormal	Please turn off power.	
E-043	X stepping motor position error	Please turn off power.	
E-044	Y stepping motor position error	Please turn off power.	
E-045	Presser not down	Step the pedal	
E-046	Not at origin cannot operate	Press key to return to origin	
E-047	Motor overload 1	Please turn off power.	
E-048	Motor overload 2	Please press Enter.	
E-049	Motor overload 3	Please turn off power.	

### 3.2 Hint Information List

No.	Name	Content of Sub-information
M-001	Up counter reaches set value	Press Enter
M-002	Down counter reaches set value	Press Enter
M-003	Not at origin, cannot operate	Return to origin firstly
M-004	Pattern data not exist	Please reload or input again
M-005	Set value is too large	Please input value within valid range
M-006	Set value is too small	Please input value within valid range
M-007	Please press "Return to Origin"	
M-008	Save parameter abnormal	Press Enter to restore the default values
M-009	Cannot find pattern in memory	Press Enter to load the default patterns
M-010	Memory full	Please delete the idle sewing data
M-011	Delete pattern data from memory?	No
M-012	Replace pattern data in memory?	No
M-013	Can not delete pattern data.	The selected sewing data is being used
M-014	Format memory?	All the patterns within the memory will be deleted
M-015	Communication error	Abnormal event occurs in the communication between the operation head and the control box. Please turn off power and check it
M-016	Beyond sewing range	Make sure pattern data is in sewing range

No.	Name	Content of Sub-information
M-017	Fail to load letter sewing file	No
M-018	Operation head not match to machine type	Please check the model and the software version
M-019	Low memory	Please delete the unused pattern data
M-020	Wrong pattern number	Please input the right pattern number
M-021	Beyond max stitch interval	No
M-022	Wrong password	Please input password again
M-023	Hardware clock error	The hardware clock has problem, please contact manufacturer for repair.
M-024	Stitch number beyond range	Please reduce stitch number
M-025	Inputted stitch interval is too low	Please input value within valid range
M-026	Inputted stitch interval is too low	Please input value within valid range
M-027	Offset origin existed	User can only input one offset origin.
M-028	Fast move is set too much or little	Please input value within valid range
M-029	Please press Return to Origin	No
M-030	Copy the pointed pattern?	No
M-031	Copy all pattern data?	No
M-032	Restore to default setting?	No
M-033	USB is pulled out	U Disk Is Pulled Out!
M-034	Cannot find pattern data in U disk	No
M-035	At least input one letter	At making pattern of letter sewing, user has to input at least one letter
M-036	No alarm record	
M-037	Replace needle	Reach set value for needle replacement, please replace needle!
M-038	Replace oil	Reach set value for oil replacement, please replace oil!
M-039	Clean machine	Reach set value for cleaning machine, please clean machine!
M-040	Different data format	Please confirm the data format
M-041	Cannot create curve	Please input again according to the standards of curve input.
M-042	Cannot insert trimming at current position	Please add trimming behind sewing data
M-043	Cannot add same function code in one position	
M-044	Cannot insert offset origin at current position	Please add offset origin after feeding
M-045	Cannot create arc or circle at the inputted point	Please input again
M-046	Cannot create overlapped sewing data	Please add overlapped sewing after close shape
M-047	Cannot insert trimming after down pause	No

No.	Name	Content of Sub-information
M-048	Cannot insert down pause before trimming	No
M-049	Not find offset sewing data	Function of offset sewing data transfer is unavailable
M-050	Not find multi-sewing data	Function of multi-sewing data transfer is unavailable
M-051	Select wrong position	No
M-052	Cannot scale	No
M-053	Distance over 12.7mm	No
M-054	Wrong pattern data	No
M-055	Create arc?	No
M-056	Create circle?	No
M-057	Create curve?	No
M-058	Create polygon?	No
M-059	Presser is not down	Please step pedal
M-060	Wrong User ID	Please input again
M-061	Fail to conform password	Please input password again
M-062	Cannot change system time	The periodical password is set. Can not change system time.
M-063	Fail to save password file	No
M-064	Fail to load password file	No
M-065	Password saved successfully	No
M-066	Fail to clear all passwords	Cannot delete password file
M-067	Fail to clear password	After the password is cleared, the file input becomes abnormal
M-068	Password file is deleted without authorization	Periodical password is deleted without authorization, please turn off machine
M-069	User ID file damage	
M-70	Input pattern name	Please input pattern name no more than 8 figures
M-71	Please clear current combination data	Press "CLR" to delete current combination data
M-72	Empty input invalid	Can not input empty password
M-73	Password not match	Current password is wrong
M-74	New password is different.	New password is different from the retry password
M-75	Touching panel correction successful	Correction is successful. Please turn off power to restart.
M-76	Clear alarm records?	Yes: Enter No: X
M-77	Delete the selected file?	Yes: Enter No: X
M-78	Copy all patterns	Cover the original patterns? Yes: Enter No: X

No.	Name	Content of Sub-information
M-79	Fail to copy file	Please check the space in memory
M-80	Fail to copy file	Please check if the USB disk is pulled out!
M-81	Fail to open file	Fail to open file
M-82	Format not match	Formats don't match, current load denied
M-83	Parameter over range	Parameter is over range. After confirmation, the parameter over range will be restored according to the default parameters!
M-84	Please create catalogue and file	Please create catalogue bakParam in U disk. Name the back-up file as backup.param and copy it to bakParam catalogue!
M-85	File I/O error	File I/O error
M-86	Please select file	Select the file for input/ output
M-87	File not exist	Cannot find the corresponding file
M-88	Not input move amount	Please input move amount
M-89	Enter touching panel correction mode?	Yes: Enter No: X
M-90	Clear accumulated running time?	Yes: Enter No: X
M-91	Clear accumulated sewing pieces?	Yes: Enter No: X
M-92	Clear accumulated power-on time?	Yes: Enter No: X
M-93	Clear accumulated stitch numbers?	Yes: Enter No: X
M-94	Periodical passwords can't be same to super password	Please input password again
M-95	Cannot change up counter (NUP)	At change, please turn off setting (NUP)
M-96	Cannot change down counter (NDP)	At change, please turn off setting (NUP)
M-97	Pattern list (hotkey) is empty	If the pattern list is empty, the system will automatically input the current pattern to list
M-98	Not select update item	Please select item for updating. At least select one item
M-99	Some selected update items don't exist.	The item not existing will be cancelled after return. For updating the rest items, please confirm again
M-100	Update successful	Update is successful, please restart machine.
M-101	Format U Disk?	Press Enter to perform formatting operation. Press Esc to quit current operation. After formatting, all pattern files will be deleted.
M-102	Can not find U disk	Please insert the U disk for formatting.
M-103	Successful	Current operation is successful!
M-104	Failed	Current operation is failed!
M-105	Format pattern list (hotkey)?	Press Enter to perform formatting operation. Press Esc to quit current operation
M-106	Cover the pattern with same name in U disk?	Press Enter to cover files. Press Esc to quit current operation
M-107	Fail to correct touching panel	Please perform correction again

No.	Name	Content of Sub-information
M-108	Letter sewing pattern saved successfully	Please enter pattern loading interface to select newly created letter sewing pattern
M-109	The selected pattern is not normal format, please transform.	Press Enter to perform transforming operation. Press Esc to quit current operation
M-110	Cannot transform this pattern	Please confirm pattern
M-111	Restore all the settings?	Yes: Enter No: X
M-112	Restore the selected item?	Yes: Enter No: X
M-113	Not select item	Please select one or more parameters
M-114	SRAM initialization	Clear all data in SRAM. Please turn off power and restore the setting of DIP switch.
M-115	Cannot copy and cover current pattern	Current pattern number in copy group, system cannot cover it.
M-116	Need transform pattern format	After transforming, user can preview the pattern
M-117	Cannot perform operation to combined pattern	Please enter pattern connection mode, press "CLR" to cancel the combined pattern
M-118	Delete original pattern?	Delete original pattern after format transforming? Yes: Enter No: X
M-119	Intermediate presser in down position	Please lift intermediate presser
M-120	Turn off machine, Bye	No
M-121	Format of pattern with 20mm stitch interval	Not support this pattern format in this system
M-122	Wrong transformed pattern format	Please confirm pattern
M-123	Transformed pattern data is too long	Please confirm pattern
M-124	Cannot open transformed pattern	Please confirm pattern
M-125	Wrong accuracy of transformed pattern	Please confirm pattern
M-126	Parameter recovery successful	Parameter recovery is successful, please restart machine
M-127	Software version saving successfully	Software version is saved to the base catalogue of U disk successfully

## 4. Appendix 2

### 4.1 Installation Size of Control Box

#### 1、 Installation Size of Control Box

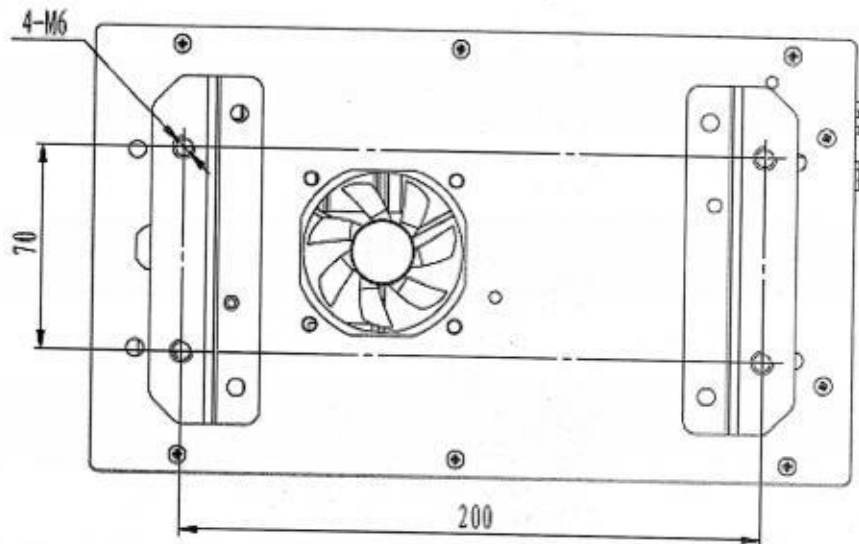
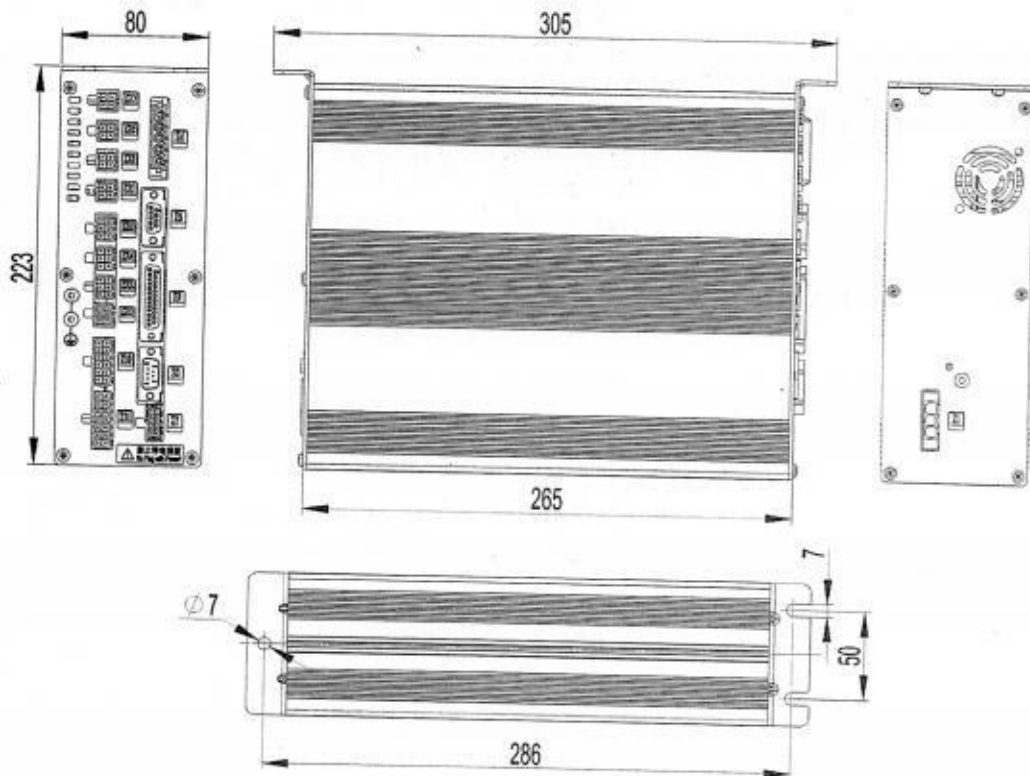
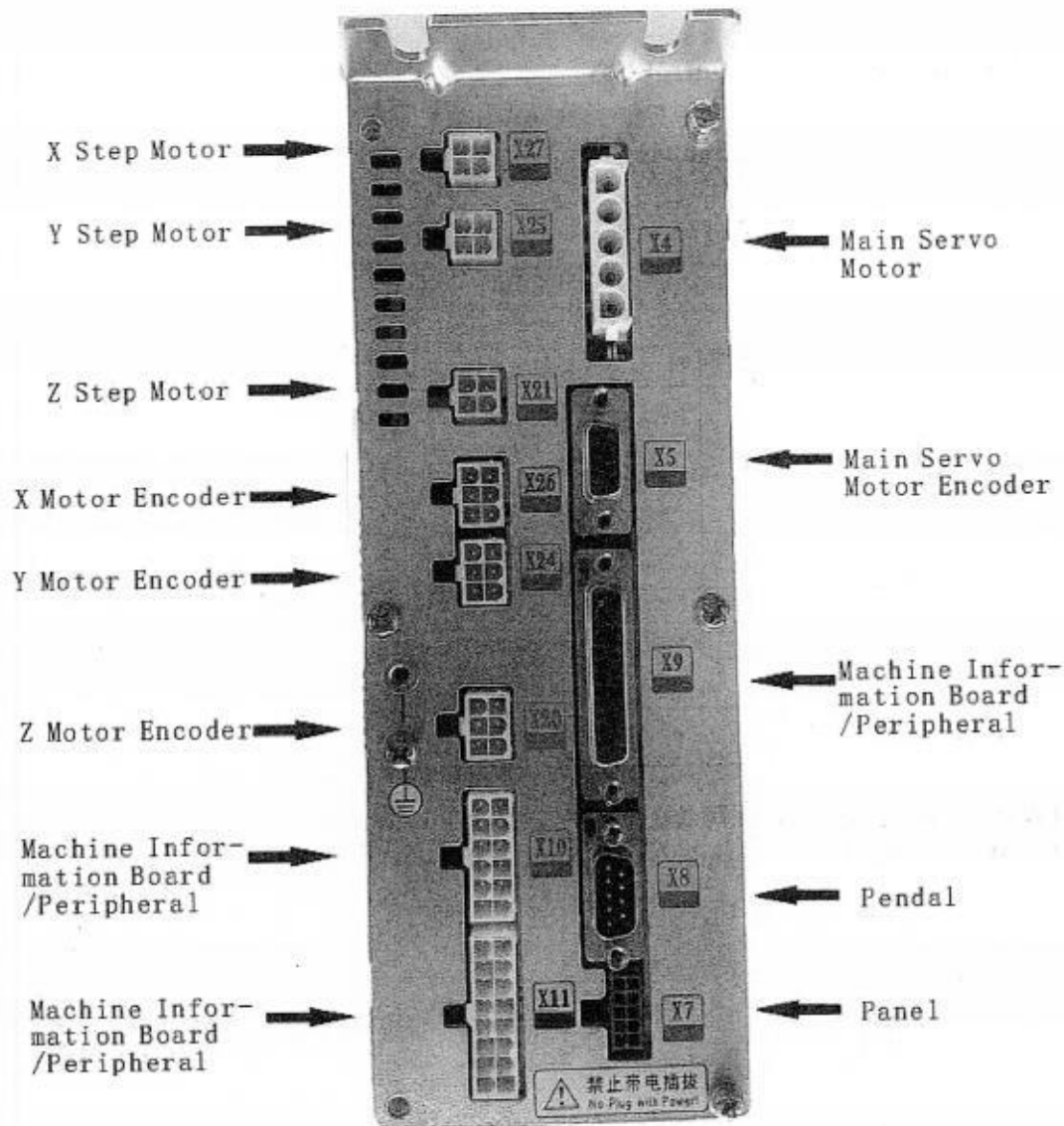

Figure 1 Installation Size (4 Holes)

#### 1、 MAS41X/MASC44X Installation Size of Control Box



4.2 External Cable Connection of Control Box



MAS41X/MASC44X Control Box Back Wiring Interface Diagram

### 4.3 Installation Size of Control Panel

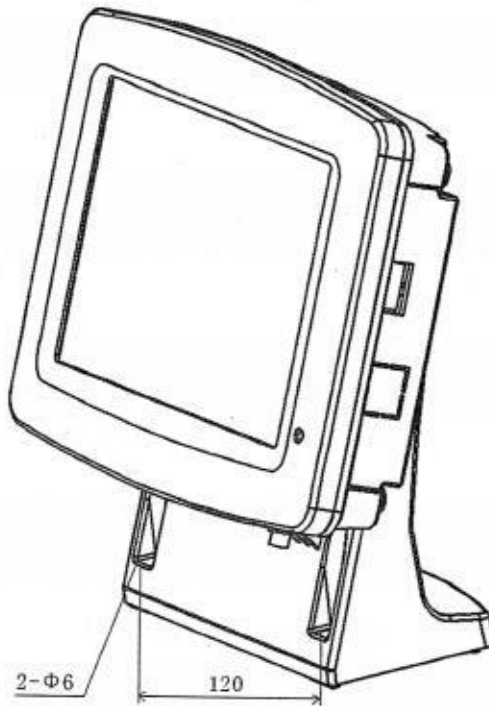

**Figure 2** Installation Size of Control Panel

### 4.4 Diagram and Cable Connection

#### 1、HSC41X Diagram

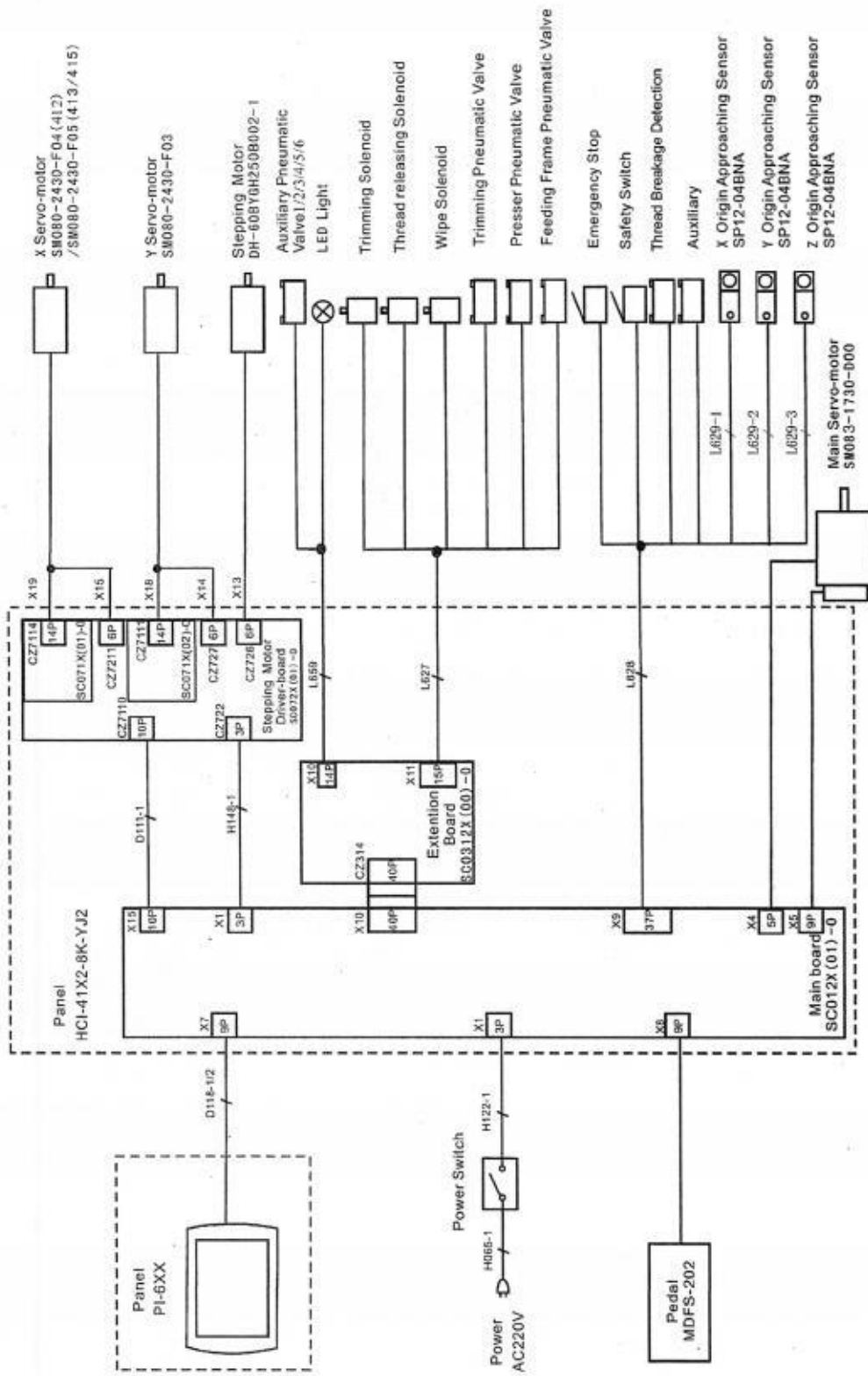

2、MASC4IX Diagram

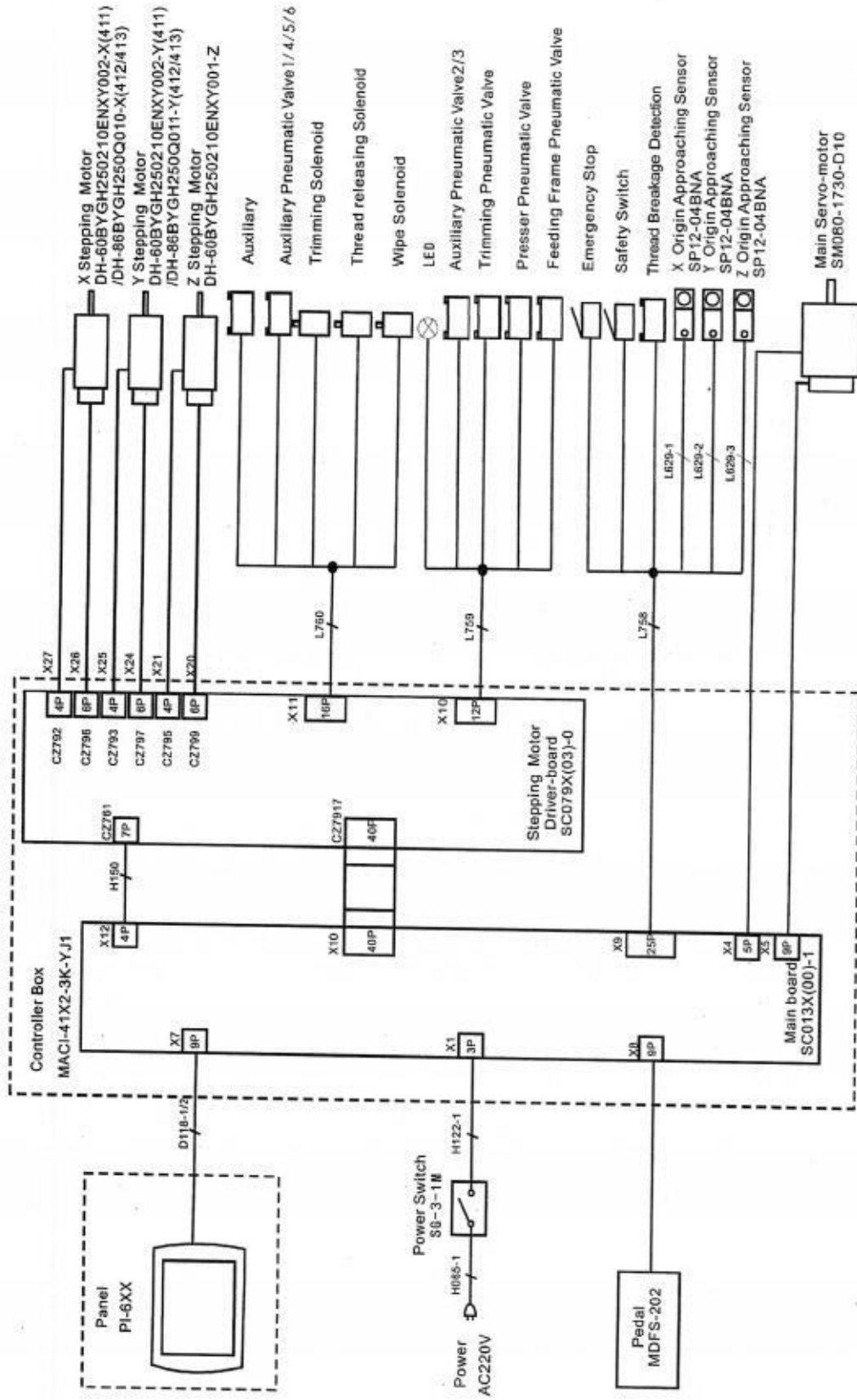



## 4.5 Cable Connection

### 1、HSC41X Cable Connection

Socket	Functions	Pin definitions
L627 (White)	Presser Pneumatic Valve	1+, 2-
L627 (Yellow)	Feeding Frame Pneumatic Valve	1+, 2-
L627 (Blue)	Trimming Pneumatic Valve	1+, 2-
L627 (Black)	Wipe Solenoid	1+, 2-
L627 (Red)	Thread releasing Solenoid	1+, 2-
L627 (White)	Trimming Solenoid	1+, 2-
L628 (White)	Auxiliary	1+, 2-
L628 (Yellow)	Emergency Stop	1+, 2-
L628 (Black)	Safety Switch	1+, 2-
L628 (White)	X Origin	1-, 2, 3+
L628 (Yellow)	Y Origin	1-, 2, 3+
L628 (Red)	Z Origin	1-, 2, 3+
L628 (Black)	Thread Breakage Detection	2
L659 (Yellow/White/White/Black/Blue/White)	Auxiliary Pneumatic 1/2/3/4/5/6	1+, 2-
L659 (Red)	LED Light	1+, 2-

### 2、MASC41X Cable Connection

Socket	Functions	Pin definitions
L758 (Yellow)	Emergency Stop	1+, 2-
L758 (Black)	Safety Switch	1+, 2-
L758 (Black)	Thread Breakage Detection	2
L758 (White)	X Origin	1-, 2, 3+
L758 (Yellow)	Y Origin	1-, 2, 3+
L758 (Red)	Z Origin	1-, 2, 3+
L759 (White)	Feeding Frame Pneumatic Valve	1+, 2-
L759 (Yellow)	Presser Pneumatic Valve	1+, 2-
L759 (Blue)	Trimming Pneumatic Valve	1+, 2-
L759 (Red)	LED Light	1+, 2-
L759 (White)	Auxiliary Pneumatic	1+, 2-

	Valve 2/3	
L760 (Yellow/Black/Blue/White)	Auxiliary Pneumatic Valve 1/4/5/6	1+, 2-
L760 (White)	Auxiliary	1+, 2-
L760 (Black)	Wipe Solenoid	1+, 2-
L760 (White)	Trimming Solenoid	1+, 2-
L760 (Yellow)	Thread releasing Solenoid	1+, 2-

### 3、MASC44X Signal Transform-connecting Board Connection SC0413 Signal Transform-connecting Board

Socket	Functions	Pin definitions
CZ134	Emergency Stop	1+, 2-
CZ139	Safety Switch	1+, 2-
CZ1313	Thread Breakage Detection	2
CZ1317/1321/1327 /1316/1320	Input 1/2/3/4/5	1-, 2, 3+
CZ133	X Origin	1-, 2, 3+
CZ138	Y Origin	1-, 3, 4+
CZ1312	Z Origin	1-, 2, 3+
CZ1326	Auxiliary Pneumatic Valve	1+, 2-
CZ135	Presser Pneumatic Valve	1+, 2-
CZ137	Feeding Frame Pneumatic Valve	1+, 2-
CZ1310	Trimming Pneumatic Valve	1+, 2-
CZ1314	Trimming Solenoid	1+, 2-
CZ136	Wipe Solenoid	1+, 3-
CZ1311	Thread releasing Solenoid	1+, 3-
CZ1315	LED Light	1+, 2-
CZ1319/1323/1325 /1318/1322/1324	Valve 1/2/3/4/5/6	1+, 2-