

For the professional user

Operating Instructions

Für den professionellen Anwender

Betriebsanleitung

Class: Efka DC1550/AB321A
Klasse: VTD410EV
ab Ausf. 1

Model:
Ausführung:

Machine number:
Maschinen-Nr.:

Dated:
Stand:

The sign of quality



You find the Strobel trademark on every Strobel machine leaving our works. And with good reason. This symbol is a guarantee of the high quality of our products. Quality which creates trust – trust in our technology, our service and, not least of all, in our good name.

Im Zeichen der Qualität

Sie finden die Strobel-Schutzmarke auf jeder Strobel-Maschine, die unser Werk verlässt. Und das aus gutem Grund. Denn dieses Zeichen garantiert Ihnen die hohe Qualität unserer Produkte. Qualität, die Vertrauen schafft – in unsere Technik, unseren Service und nicht zuletzt in unseren guten Namen.

Operating instructions CI. VTD410EV

DC1550-AB321A Sewing drive

TABLE OF CONTENTS

1	General notes on safety.....	5
2	General	7
2.1	Technical data	7
2.2	Intended usage	8
2.3	Scope of delivery	8
3	Power supply.....	9
3.1	General notes	9
3.2	Mains connection of the machine	9
3.2.1	Mains structure.....	9
3.2.2	Mains voltage and frequency	9
3.2.3	Mains connection	10
3.3	Connection of machine components.....	11
3.3.1	General notes.....	11
3.3.2	Control sockets sewing drive (AB321A).....	12
3.3.3	Motor sewing drive (DC1550) connection cables	12
3.4	Connecting a sewing machine lamp with transformer.....	13
3.4.1	General	13
3.4.2	Connecting the sewing machine lamp (control).....	14
4	Function sequence, machine class, and operating concept.....	16
4.1	General function sequence	16
4.2	Machine class – mode (basic function sequence)	17
4.3	Machine class – Hardware functions	17
4.4	Operating concept	18
4.4.1	General	18
4.4.2	Machine class – Plug-in strip (V810).....	18
5	Operating the control	19
5.1	General.....	19
5.2	Switchable button functions	20
5.2.1	General	20
5.2.2	Assignment of the switchable button functions on the operating control V810.....	20
5.2.3	Preparation threading.....	20
5.3	Direct input of the maximum speed limit (DED = “Direkte Eingabe der Maximaldrehzahlbegrenzung”)	22

6	Functions.....	23
6.1	General functions (for all classes of machines)	23
6.1.1	Basic function sequence (mode).....	23
6.1.2	Motor's direction of rotation	24
6.1.3	Selection of the position transmitter	24
6.1.4	Transmission ratio	24
6.1.5	Positions.....	25
6.1.6	Machine speed.....	26
6.1.6.1	Threading speed	26
6.1.6.2	Positioning speed	26
6.1.6.3	Maximum speed	26
6.1.7	Lifting	27
6.1.8	Reset of the machine	29
6.2	Machine-dependent functions.....	30
6.2.1	Cl. VTD410EV.....	30
6.2.1.1	Partial lifting with hold-back device.....	30
7	Parameter programming of the control	32
7.1	General.....	32
7.2	Access right during command entry.....	32
7.3	Programming at the technician or installer level	33
7.3.1	General	33
7.3.2	Programming the code number.....	33
7.3.3	Calling up and changing parameters directly	35
7.4	Setting the positions	36
7.4.1	General	36
7.4.2	Setting the reference position.....	37
7.4.3	Setting positions 1 and 2.....	38
7.5	Reset of the control.....	39
8	Service	40
8.1	Display of the needle positions	40
8.2	Display of the program number.....	41
8.2.1	Display of the Efka program number	41
8.2.2	Display of the Strobel program number.....	41
8.3	Signal test.....	42
8.3.1	General	42
8.3.2	Test of the signal outputs	42
8.3.3	Test of the signal inputs	43
8.3.3.1	General.....	43
8.4	Installation or replacement of the sewing drive's control box	44
8.5	Replacement of the sewing drive motor.....	46
8.6	Fault messages of the sewing drive AB321A.....	47
8.6.1	General information.....	47
8.6.2	Programming functions and values (parameters).....	47
8.6.3	Serious status	47
8.6.4	Hardware fault.....	47

Appendix

Circuit diagrams

Mains connection, sewing machine lamp of the sewing machine:

- 258.00.27 Mains connection plan cl. gen.
(DC1500/DC1550 with/without sewing machine lamp gen.)
- 258.00.27 Mains facility connection plan cl. gen.
(DC1500/DC1550 with/without sewing machine lamp gen.)

Connecting the sewing machine:

- 258.21.58 Electrical connection plan cl. VTD410EV as of version 1
(DC1550-AB321A)

Strobel – Switchable functions (DC1550-AB321A)

Strobel – Parameter list (DC1550-AB321A)

Spare parts data sheets

Subject to change without prior notice

1 General notes on safety

1. The sewing drive, its accessories, and auxiliary equipment may not be assembled or put into operation until the persons that have been instructed for that have read the operating manual.
2. The sewing drive, accessories, and the auxiliary equipment may be used only for their intended purpose.
3. Operation without the attached protective devices is prohibited.
4. The sewing drive has to be fully assembled before being connected to electricity.
5. Work on the electrical equipment may be done only by electricians.
6. Repairs may be carried out only by specially trained personnel.
7. The cables have to be fuse-protected for the expected power consumption and fastened well enough.
8. Cables should be laid out preferably spaced apart so that they are safely separated.
9. Cables have to be spaced at least 25 mm from moving machine parts (such as V-belts) (DIN VDE0113).
10. Make sure when connecting to the power mains that the voltage and the frequency meet the specifications given on the control's type plate.
11. Switch off the sewing drive when assembling, repairing or maintaining the machine, i.e. switch off main switch and pull the power plug (DIN VDE0113).
12. Never pull by the cable; grip the plug itself.
13. Working on parts that are under voltage is not allowed. Exemptions are covered by the DIN VDE0105 regulations.
14. Retrofitting and alterations may be carried out only if all safety regulations are observed.
15. Only original parts supplied by the manufacturer may be used for repair and maintenance.

16. Use only auxiliary equipment that has been recommended by the manufacturer or listed in the operating manual.
17. Warnings in the machine's operating manual that point out an increased risk of injury for operating personnel or damage to the machine are highlighted by the



symbol.

Observe and adhere to these instructions as well as to the generally valid safety regulations.

18. Also strictly observe the drive manufacturer's operating manual, especially the safety instructions, that are included with every drive.

2 General

2.1 Technical data

Sewing drive motor DC1550:

Maximum speed:	5000 rpm
Nom. torque:	1,9 Nm
Maximum torque:	8 Nm
Operational voltage:	230 VAC
Nom. output P1:	600 W
Maximum output:	1,800 W
Insulation class:	B
System of protection:	IP40
Length:	185.5 mm
Flange size:	80 x 75 mm
Weight:	3.120 kg
Shaft end:	cylindrical with keyway 14k6

Sewing drive control AB321A:

Voltage:	230 VAC
Frequency:	50/60 Hz +/-3%
Rated voltage:	190–240 V
Output control:	120 VA
Total output P1: (control + motor)	720 W
System of protection:	IP 40
Permitted ambient temperature:	operation: 10 °C to 45 °C storage: 10 °C to 55 °C
Permitted humidity:	max. 90% at +40 °C without condensation

2.2 Intended usage

The sewing drive (motor and control) is not an individually functional machine; it is intended for mounting into other machines.

It may not be put into operation until it is certain that the machine into which this component is installed meets the regulations of the EC Directive.

The sewing drive may be operated only:

- on machines processing sewing threads
- in dry rooms

2.3 Scope of delivery

- Sewing drive motor DC1550 Direct current motor
- Sewing drive control AB321A – sewing drive control with N206 power unit and Strobel-customised software
- Set-point adjuster EB401
- Pulse generator (position transmitter) IPG001
- Accessories kit consists of: Tie rod 400 ... 700 mm lg. Table angle bracket for EB3xx Fastening material
- Operating instructions Efka operating manual DC1550-AB321A
Efka parameter list DC1550-AB321A
Important safety instructions
- Operating controls consists of: V810
Operating controls Variocontrol V810 with Efka operating manual
- Strobel-Operating instructions BA_AB321A_410

3 Power supply

3.1 General notes

	CAUTION! Work on the sewing machine's electrical equipment or sewing drive may only be done by electricians! There is the
	DANGER of a fatal electrical shock. When working on the electrical equipment, the machine with the S0 main switch has to be switched off and the power plug pulled out! The operating instructions (including safety instructions) of the sewing machine and sewing drive must be observed!

3.2 Mains connection of the machine

3.2.1 Mains structure

	CAUTION! The sewing drive may only be connected to an earthed alternating voltage mains, i.e. with an earth conductor system!
---	--

The sewing drive or sewing machine may only be operated with an earth conductor at a functioning earth conductor system that complies with all local provisions and regulations.

The protective effect of the earth conductor must not be voided when connecting, for instance, with extension cords without earth conductors. Any interruption to the earth conductor inside or outside the sewing drive is prohibited.

3.2.2 Mains voltage and frequency

	CAUTION! The range of the rated voltage and frequency for the sewing drive is 190–240 V 50/60 Hz. The mains voltage and frequency have to lie within this range!
---	---

3.2.3 Mains connection



CAUTION!

The sewing machine **must** be connected to the mains power supply with a plug connection (power plug)!



CAUTION!

The safety instructions in Chapter 1 must be observed when connecting and laying the connection cables.

When laying the cables, ensure in particular that distance is kept to movable parts (e.g. V-belts) and their mountings.

The mains cable may be fused with max. 16 A.

See also the circuit diagram

258.00.27 Mains connection plan cl. gen.
(DC1500/DC1550 with/without sewing machine lamp gen.)

258.00.27 Mains facility connection plan cl. gen.
(DC1500/DC1550 with/without sewing machine lamp gen.)

that is found in the appendix.

Instructions on laying the cables:

Protect the mains cable being laid against any expected stresses and secure adequately (incl. possible strain relief).

Lay and secure the mains cable so that it has a minimum distance of 25 mm to the movable parts.

To ensure safe separation, it is preferable to lay the mains cables spatially apart from other cables/low voltage lines. A rectangular crossing is better than one at a small angle; avoid a parallel guide.

3.3 Connection of machine components

3.3.1 General notes



CAUTION!

Before plugging in or pulling a connector plug, it is necessary to switch off the drive with the S0 main switch and to disconnect the power plug.



CAUTION!

The safety instructions in Chapter 1 must be observed when selecting an assembly location, and when laying the connection cables.

When laying the cables, ensure in particular that distance is kept to movable parts (e.g. V-belts) and their mountings.

See also the circuit diagram and assembly plans

258.21.58 Electrical connection plan cl. VTD410EV as of version 1
(DC1550-AB321A)

that are found in the appendix.

Laying the cables:

Protect the cables being laid against any expected stresses and secure adequately (incl. possible strain relief).

Lay and secure the cables so that they have a minimum distance of 25 mm to the movable parts.

To ensure safe separation, it is preferable to lay cables and low voltage lines spatially apart from other. A rectangular crossing is better than one at a small angle; avoid a parallel guide.

3.3.2 Control sockets sewing drive (AB321A)

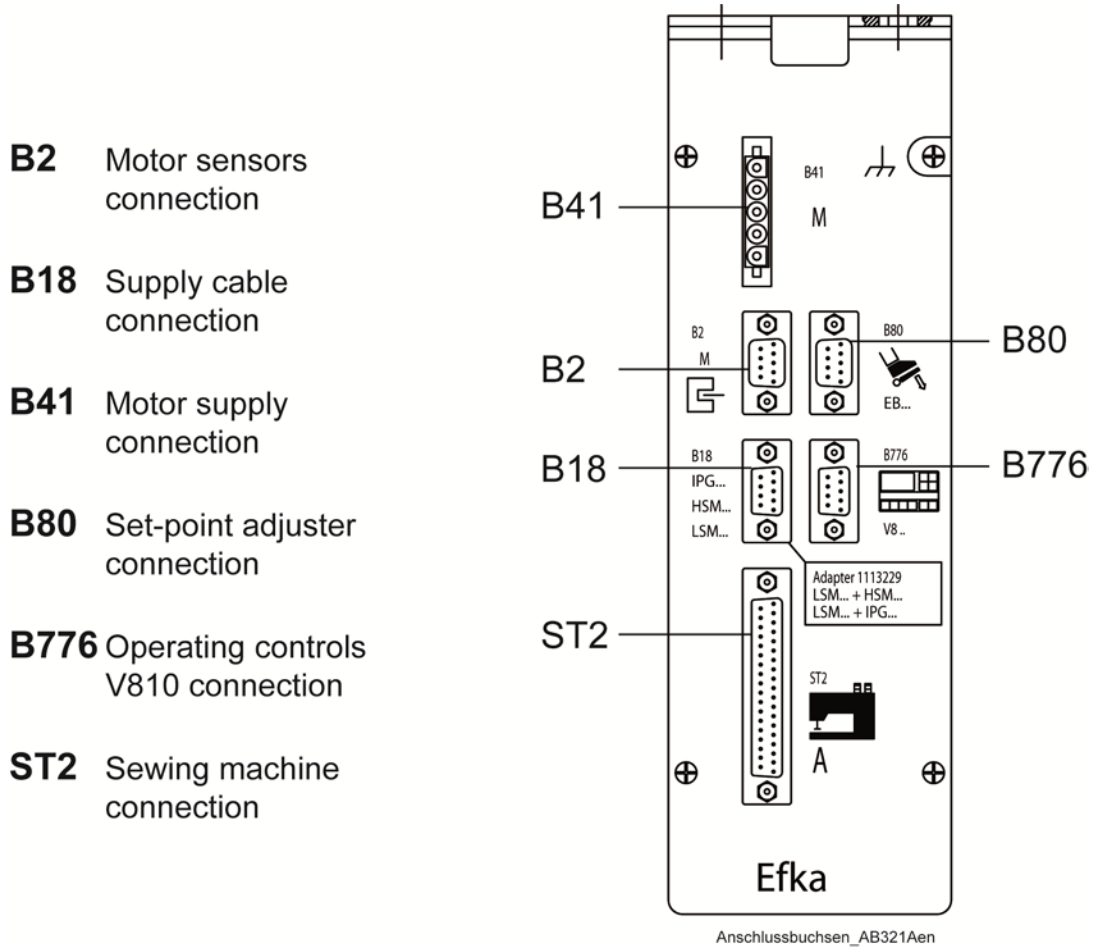

3.3.3 Motor sewing drive (DC1550) connection cables

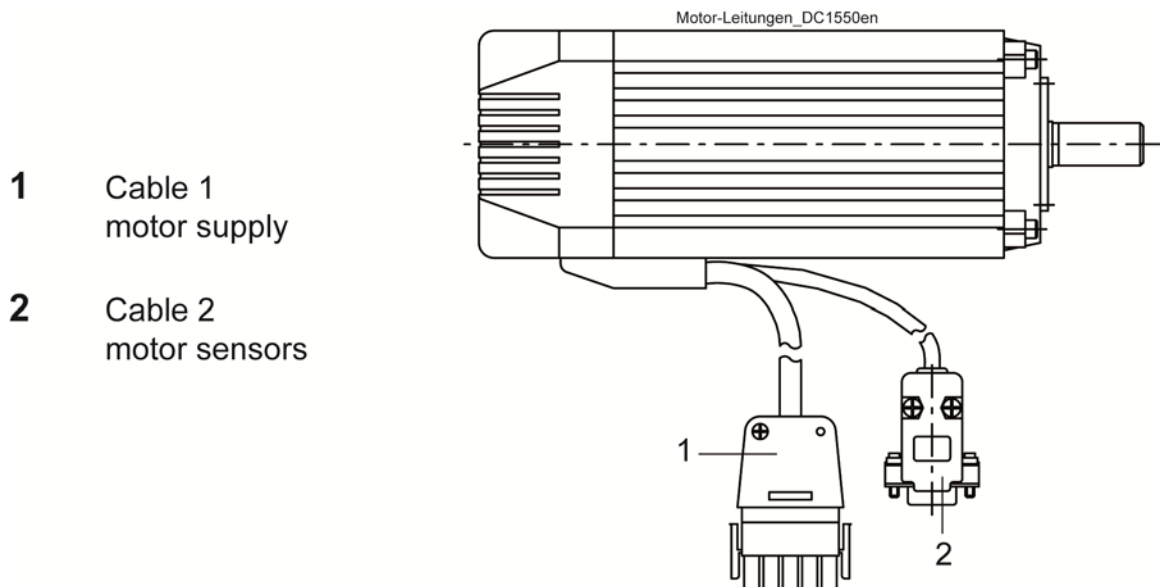

3.4 Connecting a sewing machine lamp with transformer

3.4.1 General



CAUTION!

When connecting a sewing machine lamp be sure to observe the safety instructions. In particular the connection of the sewing machine lamp may be done only by an electrician.



CAUTION!

If there is a separate main switch on the sewing machine, then the sewing machine lamp always needs to be connected to the separate S0 main switch and not on the control.



CAUTION!

The sewing machine lamp may not be put into operation until its operation mode is known. The sewing machine lamp may only be used as intended.



CAUTION!

Before connecting the sewing machine lamp, check that the electrical connection specifications of the sewing machine lamp, in particular the network voltage and frequency, are appropriate for your electric network.



CAUTION!

Once the sewing machine lamp has been connected it is constantly under voltage (190–240 V) even when the S0 main switch on the control is off. Only sewing machine lamps with a transformer may be connected to the control.

3.4.2 Connecting the sewing machine lamp (control)



CAUTION!

Before opening the control it is necessary to switch off the drive by the S0 main switch and to disconnect the power plug.



CAUTION!

Discharge your body's static before opening the control. To do so touch a well-earthed part that has a metal surface.

- Switch the control off electrically by the main switch S0 (Fig. 4) and pull the power plug.
- Unscrew the control from the machine table.
- Open 2 screws (A) in the front and back (Fig. 3).
- Take off left housing part (Fig. 3).
- Pull the connection cable of the sewing machine lamp through the separate cable bushing and fasten with cable binders. Be sure to read the corresponding circuit diagrams in the appendix: "Electric mains, sewing drive - sewing machine lamp".
- In the (B) area clamp the blue and brown stranded conductors in the 2-pin strip terminal on the printed board (Fig. 3). Be sure to read the corresponding circuit diagrams in the appendix "Electric mains, sewing drive – sewing machine lamp".
- Close the housing and screw back together.
- Mounting the control to the machine table.
- Attach sewing machine lamp and lay out cables.

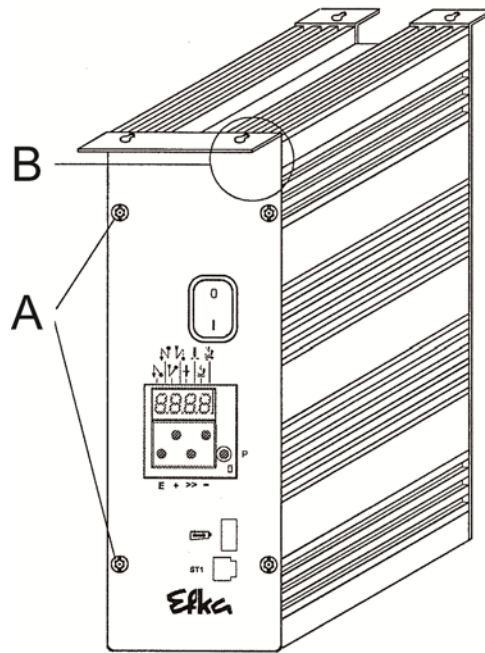

Anschluss_Nähleuchte_AB321A

Fig. 3

4 Function sequence, machine class, and operating concept

4.1 General function sequence

The AB321A control features software customised for Strobel with the appropriate function sequence for the selected Strobel machine classes.

The exact function sequence for a machine class is determined at the control by the basic function sequence (mode), the function parameters and the switchable functions. The control is optimally control-technically adapted to the respective machine class by correct settings.

By setting the mode (parameter F-290) at the control the basic function sequence is set for the selected machine class.

The exact function sequence for the selected machine class is specified by setting certain function parameters or button functions while taking into account any sub-classes or their optional features.

The function parameters or the button functions are preset in the control by preset values or functions. Some of these parameters or functions need to be altered from the preset values or functions for certain machine classes depending on the sub-class and optional features.

When a complete machine or a top part with sewing drive is delivered all function parameters and button functions have been already properly set.

In case of questions or when ordering spare parts concerning a control, the machine class, machine number, Efka program number (8.2.1 Display of the Efka program number) and the Strobel program number (8.2.2 Display of the Strobel program number) must be given completely.

4.2 Machine class – mode (basic function sequence)

Sewing drive control AB321A:

Machine class	Mode (basic function sequence)							
	5							
VTD410EV version 1	X							

4.3 Machine class – Hardware functions

Sewing drive control AB321A / jack ST2:

Machine class	Function									
	Outputs:							Inputs:		
	Lifting (LÜ = "Lüftung") ST2/35	Partial lifting (TLÜ) ST2/37	Hold back (EINH) ST2/28	Thread tension lifting (FSPL) ST2/27				Button for partial lifting (T-TLÜ) ST2/11	Analog input setpoint device EB401 (ST2/3)	
VTD410EV version 1	X	X	X					X		

4.4 Operating concept

4.4.1 General

The machine is programmed and operated only by the V810 control panel, which is part of the standard delivery and plugged to the AB321A control.

4.4.2 Machine class – Plug-in strip (V810)

	<p>C A U T I O N !</p> <p>The plug-in strip over the operating control's buttons is only valid for the mode whose functions match the symbols. For modes with other functions replace the respective plug-in strip on the operating controls by pulling it out to the side.</p>
---	--

Machine class	Plug-in strip (V810)							
		3						
VTD410EV version 1	X							

5 Operating the control

5.1 General

The controls are switched on and off by the S0 main switch, which is located on the right side of the machine, below the tabletop (Fig. 4).

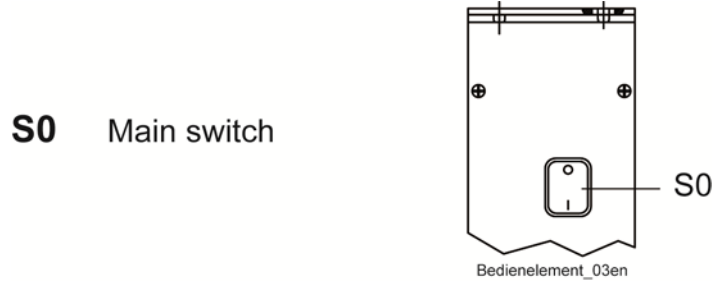
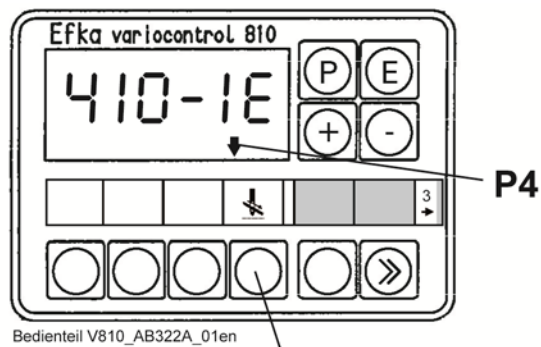

Fig. 4

Assignment and display of button functions on operating control V810 (Fig. 5)



Button 4

Button 4 "Preparation threading" function

P4 Indication whether "Preparation threading" function is ON/OFF

Fig. 5

5.2 Switchable button functions

5.2.1 General

Switchable button functions can be changed by pressing a button. The switch status is saved and indicated by the assigned arrows over the respective button (refer to Fig. 5). The function is active until a renewed pressing of the button or an event changes the switch status.

Depending on the selection of the machine class, the various buttons are assigned different switchable functions.

5.2.2 Assignment of the switchable button functions on the operating control V810

Button	Cl. 410	
	Plug-in strip 3	Plug-in strip
"4"	Preparation threading On/Off Arrow P4 = on/off	

5.2.3 Preparation threading



CAUTION!

The function "Preparation threading" does **not** replace the electrical switching off of the machine during threading.

This function serves only to ensure that the needle is in the threading position when the machine is switched off.

Function with operating control	Button (V810)
Preparation threading	4

The function Preparation threading is activated by this function.

Preparation threading function is activated ⇒ left arrow (4) =On

Preparation threading function is deactivated ⇒ left arrow (4) =Off

Display after activation of the preparation threading function:

On the V810 operating control: Display shows: -StoP-

Switching is only possible outside the stitch with open lifting.

The function is saved after power off.

Sequence of the "Preparation threading" function:

The sewing machine has to stand outside the stitch in Pos. 2 (Lifting opened):

- Press button "4" (Activate preparation threading function):
 - "-StoP-" is displayed and the left arrow (4) is switched on by button 4.
 - The controller disables the sewing pedal, i.e. the sewing drive can not be started.
 - The control blocks all input functions (inputs), i.e. no functions can be initiated any more (e.g. by pressing a connected knee button).
 - The sewing machine runs at threading-in speed to pos. 1.

Switch off the sewing machine by the main switch S0.

After threading the sewing machine with the main switch S0 on. The display shows "STOP" is displayed (Luke arrow above key 4 A) and the Sewing pedal and the inputs are blocked:

- Press button "4" again (deactivate preparation threading function):
 - Under the assumption that the Sewing pedal is not operated, or no input is activated, the sewing machine with threading speed runs in Item 2.
 - - The controls are the input functions and the Sewing pedal free.
 - "410-1E" is displayed and the left arrow (4) is switched off over button 4.
 - The sewing machine is ready for sewing again.

5.3 Direct input of the maximum speed limit (DED = “Direkte Eingabe der Maximaldrehzahlbegrenzung”)

Function with operating control	Button (V810)
Direct input of the maximum speed limit	+/-

Function:

In order to limit the maximum speed of the sewing machine to the appropriate rate for the task the setting can be adjusted at the direct function level.

The setting can be changed at the V810 operating control by pressing the "+/-" buttons while the sewing machine is running or pausing.

The setting range lies between the parameter values F-111 (maximum value) and F-121 (minimum value).

The current value is shown in the display for about 2 seconds after the button is pressed.

6 Functions

6.1 General functions (for all classes of machines)

6.1.1 Basic function sequence (mode)

Function with operating control	Parameter
Basic function sequence (machine mode)	F-290

The individual basic function sequences of the control can be selected by this function.

	<p>CAUTION!</p> <p>A setting should be done only during the installation of the sewing machine (refer to chapter 8.4 Installation or replacement of the sewing drive's control box)!</p> <p>The setting has to be done very carefully because a faulty setting can damage the control or the sewing machine.</p> <p>Disconnect the connection cables of the in- and outputs before setting the basic function sequences.</p> <p>It needs to be additionally ensured that the intended sewing machine is installed for the set basic function sequence.</p> <p>The setting with function F-290 is to be done only after the power is switched on.</p>
--	---

Function with operating control	Parameter
Selection of the number of the plug-in strip for the V810 operating control	F-291

This function selects the plug-in strip for the V810 operating control.

Depending on the machine class used, the respective plug-in strip on the operating controls has to be exchanged by pulling it out to the side.

6.1.2 Motor's direction of rotation

The rotational direction of all Strobel machine classes is to the right, i.e. the correct rotation of the machine hand wheel is clockwise when looking at it.

The rotational direction is independently regulated by the control software and may therefore not be programmed.

6.1.3 Selection of the position transmitter

The selection of the position transmitter is independently regulated by the control software and may therefore not be programmed.

6.1.4 Transmission ratio

The transmission ratio is independently regulated by the control software and may therefore not be programmed.

6.1.5 Positions

Function with operating control	Parameter
Setting the reference position	F-170

This function sets the reference position.

Function with operating control	Parameter
Setting positions 1 and 2	F-171

This function sets the two positions.

The AB321A control has two positions. The positions are set exclusively by programming the control.

A position is determined by a position input and output value. The values reference position. A rotation is divided into 360 steps (increments), i.e. 1 step = 1 degree.

CAUTION!

In order to ensure a safe or proper sequence there should be at least 30 steps (increments) between "Position 2 input" and "Position 1 input".

Furthermore there always needs to be 25 steps between the position input value and output value of the same position (very important for the internal function of the control).

For the precise programming of the individual positions refer to chapter "7.4 Setting the positions".

The setting of the positions can be easily checked using the F-172 function. Refer to chapter "8.1 Display of the needle position".

6.1.6 Machine speed

6.1.6.1 Threading speed

Function with operating control	Parameter
Threading speed	F-741

The threading speed is the speed of the machine during switching on and off of the function "Preparation threading".

6.1.6.2 Positioning speed

Function with operating control	Parameter
Positioning speed n1	F-742

The positioning speed is the speed of the machine during a positioning process.

6.1.6.3 Maximum speed

Function with operating control	Parameter
Maximum speed n2-	F-111

The maximum speed is the highest speed the machine can reach (pedal position "+12") or that can be set by DED.

CAUTION!

The machine's maximum permitted speed may not be surpassed.
When using the position transmitter integrated in the motor (incremental pickup) the transmission ratio also always has to be properly set.
A faulty setting can damage the sewing machine.

6.1.7 Lifting

The following functions have an influence on lifting:

Function with or without operating control	Parameter
Lifting (LÜ) with pedal position “-1”	F-019

This function opens the lifting with pedal position “-1”, i.e. without activating the thread trimmer.

Explanation of the parameter values used:

F-019 = 1 Lifting with pedal position “-1” blocked.

F-019 = 3 Lifting with pedal position “-1” released.

The lifting is open as long as the pedal is in the “-1” pedal position.

Function with or without operating control	Parameter
Switch delay of the lifting (LÜ) at pedal position “-1”	F-201

This function sets a delay time for the evaluation of the “-1” pedal position.

Setting a long delay prevents unintentional lifting before the thread trimming during a change of pedal position “ ≥ 0 ” to “-2”.

Function with or without operating control	Parameter
Starting delay after the lifting signal (LÜ) switches off	F-202

This function sets a delay before starting the sewing machine that becomes active when the sewing machine starts up (with pedal position “>0” / lifting open).

The starting delay has to be set so that when the pedal is fully pressed, the lifting is definitely closed before the sewing machine starts up.

Function with or without operating control	Parameter
Delay time lifting (LÜ) On	F-288

This function sets a delay time for the lifting that becomes active after the sewing machine is positioned at the stitch end.

Function with or without operating control	Parameter
Lifting mode	F-236

This function is used to determine the individual function processes for the lifting.

Explanation of the parameter values used:

- F-236 = 0 Lifting is registered at the stitch end (pedal position “-2”).
Registration doesn't end until pedal position “≥ 1”.
- F-236 = 2 Lifting is registered at the stitch end (pedal position “-2”).
Registration ends already at pedal position “+1/2”.

The electrical lifting signal can also be clocked. This function can be used when the spool of the attached magnetic valve or magnet does not have 100% continuous duty.

The lifting is opened by full drive. Afterwards there is an automatic switch to partial drive to reduce the load on the drive and the attached spool of the magnetic valve or magnet.

Function with or without operating control	Parameter
Full drive time lifting (LÜ)	F-203

This function sets a full drive time for the lifting that becomes active after the signal is switched on.

Function with or without operating control	Parameter
Holding force (continuous duty) of the lifting (LÜ)	F-204

This function sets holding force (continuous duty) of the lifting.

Value	Holding force	Continuous duty
1	weak holding force	1%
100	strong holding force (full drive)	100%

	<p>CAUTION!</p> <p>If the holding force is too strong (continuous duty = ED), then the spool or drive can be ruined.</p> <p>Be sure to observe the permissible continuous duty of the spool and set the percentile value appropriate for it.</p>
---	---

Function with or without operating control	Parameter
Upper limit (F-204) continuous duty for lifting (LÜ)	F-254

This function sets the upper limit of the holding force (continuous duty) of the lifting that can be set in parameter F-204.

6.1.8 Reset of the machine

Function with or without operating control	Parameter
Reset of the machine	F-764

This function allows the control to "factory settings" reset and the machine is re-initialized.

By entering a parameter value that is "unequal to 4711" the function is activated.

The positions of the machine also need to be re-adjusted after a reset.

The programmed stitch programs are not changed.

6.2 Machine-dependent functions

6.2.1 Cl. VTD410EV

6.2.1.1 Partial lifting with hold-back device

The following functions have an influence on partial lifting with hold-back device:

Function with or without operating control	Parameter
On-time of the partial lifting (TLÜ)	F-751

This function sets the on-time of the partial lifting.

Partial lifting sequence:

1. Sewing machine is away from the stitch in pos. 2 (lifting open):

- Partial lifting with hold-back device is blocked.

2. Sewing machine is in the stitch in pos. 1 (lifting closed):

- Press knee button:
 - The control blocks the sewing pedal, i.e. the sewing process or the sewing drive cannot be started by the sewing pedal anymore.
 - The control opens the partial lifting and switches on the hold-back device.
 - Following a settable on-time for the partial lifting it is closed again.
 - The control releases the sewing pedal and the sewing machine is ready for sewing with the hold-back device.
- Press knee button again:
 - The control blocks the sewing pedal, i.e. the sewing process or the sewing drive cannot be started by the sewing pedal anymore.
 - The control opens the partial lifting and switches off the hold-back device.
 - Following a settable on-time for the partial lifting it is closed again.
 - The control releases the sewing pedal and the sewing machine is ready again for normal sewing.

3. Sewing machine runs:

- Press knee button:
 - The sewing machine is stopped and positioned in pos. 1.
 - The control blocks the sewing pedal, i.e. the sewing process or the sewing drive cannot be started by the sewing pedal anymore.
 - The control opens the partial lifting and switches on the hold-back device.
 - Following a settable on-time for the partial lifting it is closed again. The control releases the sewing pedal and the sewing machine starts sewing with the hold-back device.

- Press knee button again: (sewing machine runs with activated hold-back device)
 - The sewing machine is stopped and positioned in pos. 1.
 - The control blocks the sewing pedal, i.e. the sewing process or the sewing drive cannot be started by the sewing pedal anymore.
 - The control opens the partial lifting and switches off the hold-back device.
 - Following a settable on-time for the partial lifting it is closed again. The control releases the sewing pedal and the sewing machine starts again.

7 Parameter programming of the control

7.1 General

CAUTION!

The precise parameter values can be found in the Strobel parameter list.

Parameters that are not described in the Strobel parameter list have to be reset according to the Efka parameter list on the reset values.

The values given in the parameter list, especially the setting times, are guide values that can be adapted as necessary to the machine concerned.

7.2 Access right during command entry

In order to prevent changes of preset function the entry of commands is distributed onto several levels.

Access right is given to:

- the installer at the highest level and all subsequent levels by code number 3112.
- the technician at the next lower level and all subsequent levels by code number 1907.
- the operator at the lowest level without code number.

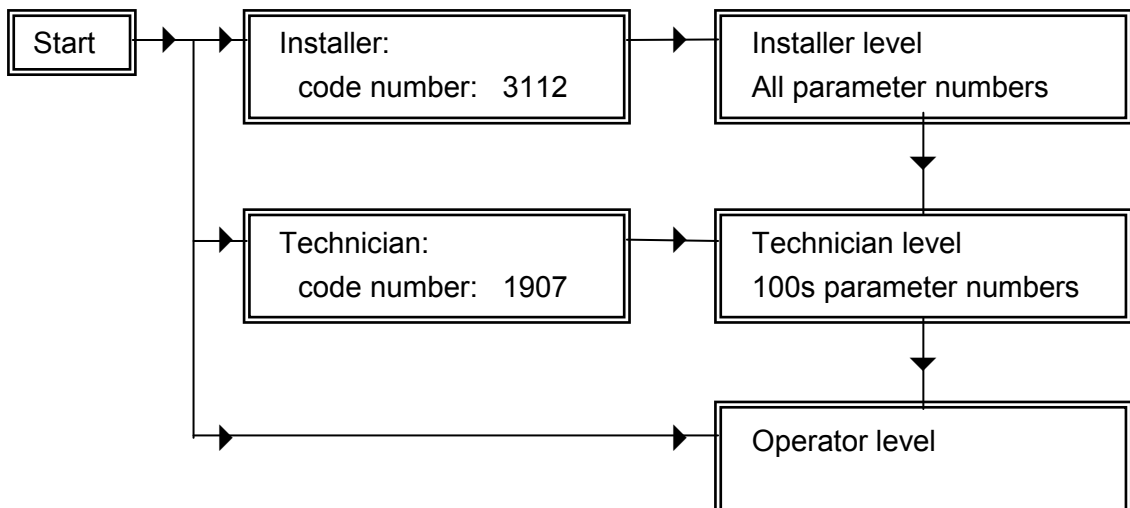

Fig. 6

7.3 Programming at the technician or installer level

7.3.1 General

The parameter values can be changed at the technician or installer level only when a code number has been entered.

Code number at the technician level	=>	1907
Code number at the installer level	=>	3112

Parameter values changed at the technician or installer level are saved immediately upon exiting the programming level.

The parameter numbers shown in the illustrations may not be available in all modes. In such cases the next higher parameter number is displayed in the display.



CAUTION!

Changing the parameter values at the technician or installer level has to be done very carefully because a faulty setting can damage the control or the sewing machine.

7.3.2 Programming the code number

for example the code number "1907" for the technician level

1. Press the "P" button and the S0 main switch at the same time.
Display is:

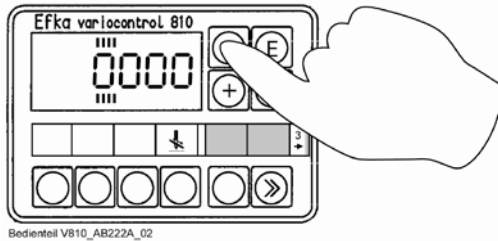

+

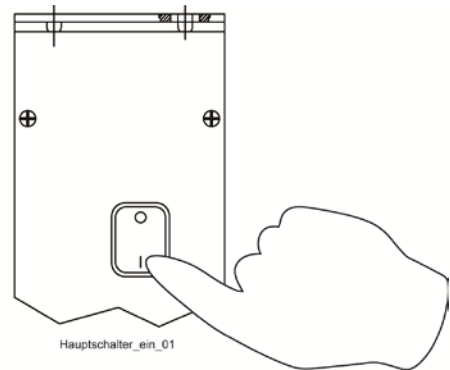

2. Press "+/-" button; in this case the "+" button. Numerical value of the digit is changed:
3. Press ">>" button. Second digit blinks:

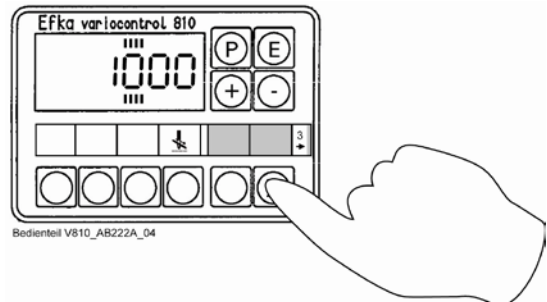
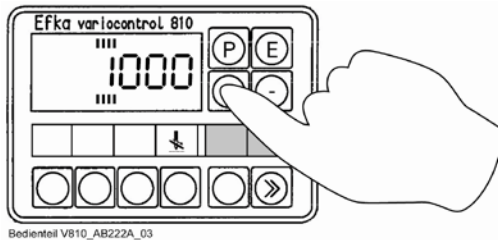

4. Press “+/-” button; in this case the “-” button.
Numerical value of the digit is changed:

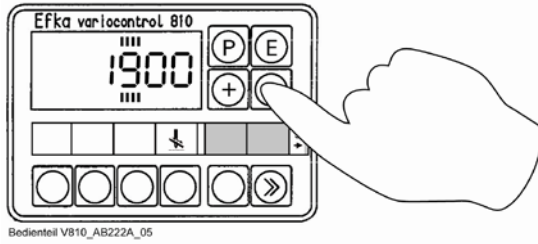

5. Press “>>” button.
Third digit blinks:

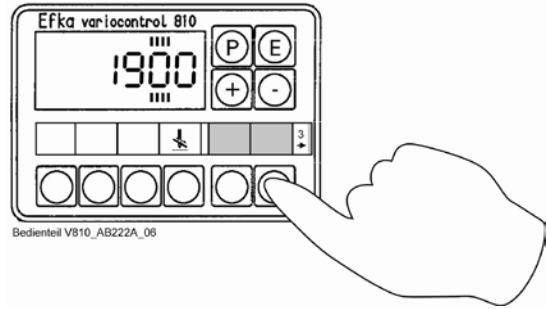

6. Press “>>” button.
Forth digit blinks:

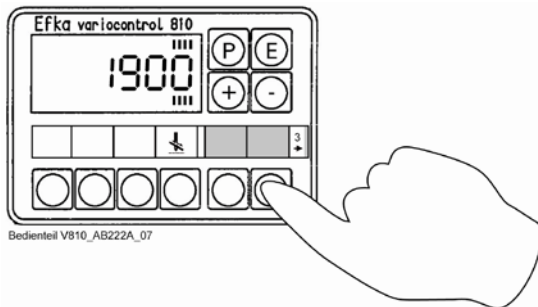

7. Press “+/-” button; in this case the “-” button
3 times.
Numerical value of the digit is changed:

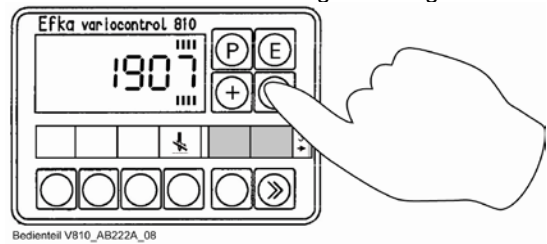

8. Press “E” button.
The first parameter at the technician level
is displayed:

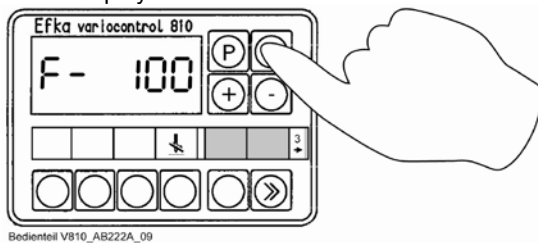

7.3.3 Calling up and changing parameters directly

Using the example of the F-111 parameter whose value is changed from 2500 to 2000.

1. After entering the code number.
First parameter is displayed:

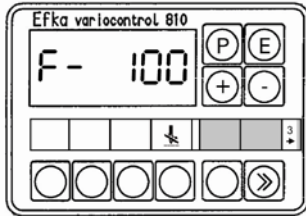

Bedienteil V810_AB222A_10

2. Press "+/-" (in this case, "+") to select parameter until F-111 appears:

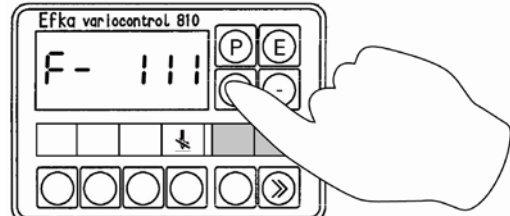

Bedienteil V810_AB222A_11

3. Press the "E" button.
Parameter value is displayed:

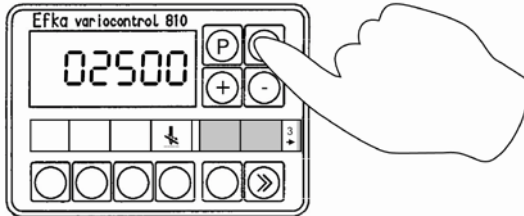

Bedienteil V810_AB222A_12

4. Press "+/-" (in this case, "-") to adjust the parameter value until 2000 appears:

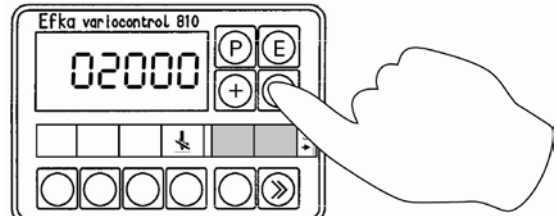

Bedienteil V810_AB222A_13

5. Press the "P" button.
Parameter is displayed:

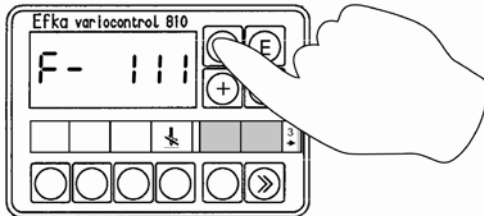

Bedienteil V810_AB222A_14

In this way all parameters can be called up at will and changed at the programming level.

After changing the last parameter value the programming at the programming level has to be exited as follows:

6. Press the "P" button again.
The display then shows after 3 seconds:

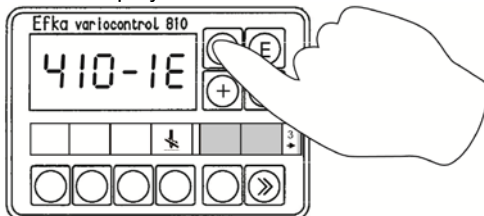

Bedienteil V810_AB322A_02

7.4 Setting the positions

7.4.1 General

The individual positions of the sewing machine (machine positions) can be found in the respective operating manual of the sewing machine. The setting of the positions can be easily checked using the F-172 function. Refer to chapter "8.1 Display of the needle position".

The control requires a pulse generator that is mounted on the main shaft (handwheel) of the machine and that detects the mechanical position of the machine and sends it to the control.

The pulse generator has to be mounted on the machine as follows:

The pulse wheel (1) from the encoder must be positioned so that the outgoing edge (disc transition from "light" to "dark" in the machine direction) in the sensor (2) when the machine with the needle reaches the front position (Fig. 7).

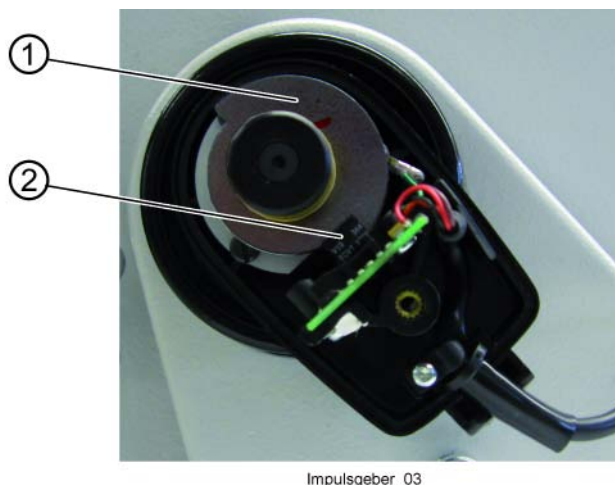

Fig. 7

7.4.2 Setting the reference position

After entering the code number "1907" for the technician level:

- Select parameter F-170. Display shows: F-170
- Press the "E" button. Sr1[°]
- Press ">>" button. PoS0

Turn the handwheel in the machine's direction of rotation until the circulation symbol disappears from the display. Set the handwheel or needle to the sewing machine's reference position (see operating manual of the sewing machine).

- Press the "E" button. F-171
- Exit the programming level by pressing the "P" button

or

continue with chapter: "7.4.3 Setting positions 1 and 2" as of step 2.

7.4.3 Setting positions 1 and 2

After entering the code number "1907" for the technician level:

- Select parameter F-171. Display shows: F-171
- Press the "E" button. [°]
- Press ">>" button. P1E xxx

Turn the handwheel in the machine's direction of rotation until the position value in the display changes. Then set the handwheel or needle to the position 1 of the sewing machine (see operating manual of the sewing machine).

- Press "E" button. Display shows: P2Exxx

Turn the handwheel in the machine's direction of rotation until the position value in the display changes. Then set the handwheel or needle to the position 2 of the sewing machine (see operating manual of the sewing machine).

- Press "E" button. Display shows: P1Axxx

Turn the handwheel in the machine's direction of rotation until the position value in the display changes. Then turn the handwheel until the position value "P1E + 25" is displayed (please refer to chapter "6.1.5 Positions").

- Press "E" button. P2Axxx

Turn the handwheel in the machine's direction of rotation until the position value in the display changes. Then turn the handwheel until the position value "P2E + 25" is displayed (please refer to chapter "6.1.5 Positions").

- Press the "P" button. Display shows: F-171
- Press the "P" button.

7.5 Reset of the control

After entering the code number "3112" at the installer level:

- | | |
|--|----------------------|
| - Select parameter F-764. | Display shows: F 764 |
| - Press the "E" button. | 004711 |
| - Press the buttons "+/-" to change the value "4711", e.g. with the "-" button to "4710" | 004710 |
| - Press the "P" button. | F 764 |
| - Press the "P" button. | |

This function is used to reset the control to "factory settings" and the machine is re-initialised.

The positions of the machine also need to be re-adjusted after a reset (refer to chapter "7.4 Setting the positions").

8 Service

8.1 Display of the needle positions

Function with V810 operating control	Parameter
Display of the positions 1 and 2 (down / up)	F-172

The setting of the positions can be easily checked using this function.

After entering the code number "1907" for the technician level:

- Select parameter F-172. Display shows: F-172
- Press the "E" button. Sr3
- Turn handwheel according to the motor's direction of rotation.

Display on the V810 operating control:

left arrow over the "4" button
is switched on ⇒ Position 1E

left arrow over the "4" button
is switched off ⇒ Position 1A

right arrow over the "4" button
is switched on ⇒ Position 2E

right arrow over the "4" button
is switched off ⇒ Position 2A

- Press the "P" button. Display shows: F-172
- Press the "P" button.

8.2 Display of the program number

8.2.1 Display of the Efka program number

Function with V810 operating control	Parameter
Display of the Efka program number with index and identification number.	F-179

This function displays of the Efka program number of the control with index and identification number.

Example: Program number: 5130E
Date: 05100508

After entering the code number "1907" for the technician level:

- Select parameter F-179. Display shows: F-179
- Press the "E" button. [°]
- Press ">>" button. 5130E
- Press the "E" button. 051005
- Press the "E" button. 08
- Press the "P" button. F-179
- Press the "P" button.

8.2.2 Display of the Strobel program number

Function with V810 operating control	Parameter
Display of the Strobel program number	F-762

This function displays of the Strobel program number of the control with index and identification number.

Example: Program number: 00301

After entering the code number "1907" for the technician level:

- Select parameter F-762. Display shows: F-762
- Press the "E" button. 00301
- Press the "P" button. F-762
- Press the "P" button.

8.3 Signal test

8.3.1 General

Function with V810 operating control	Parameter
Test of the signal in- and outputs	F-173

The external inputs and the transistor power outputs with the connected actuators (e.g. magnetic valves) can easily be checked by this function.

The sewing machine cannot be started during the test.

8.3.2 Test of the signal outputs

The signal outputs can be tested as follows:

After entering the code number "1907" for the technician level:

- Select parameter F-173. Display shows: F- 173
- Press the "E" button. in oFF
- Press the "+/-" buttons to select the desired output (see table).

Display V810 operating control	Machine class	Output Assignments
oUt FL	all	Lifting (LÜ)
oUt 1	VTD410EV	Partial lifting (TLÜ)
oUt 2	VTD410EV	Hold back device (EINH)

- Press ">>" button – activate selected output. XX
- Press the "P" button. F-173
- Press the "P" button.

8.3.3 Test of the signal inputs

8.3.3.1 General

The signal inputs can be tested as follows:

After entering the code number "1907" for the technician level:

- Select parameter F-173. Display shows: F-173
- Press the "E" button. in oFF
- Press input to be tested manually. in iXX

Since all external inputs are monitored simultaneously by the control, only the contact for the output to be tested may therefore be connected and activated during a test. An additional input to a closed contact is no longer detected or only the lowest input with a closed contact is displayed. It is therefore necessary to take the required steps to ensure every contact of the inputs is open prior to testing. "in oFF" is displayed. Now each input can be tested separately.

Display V810 operating control	Machine class	Input assignments
in oFF	all	All inputs not activated
in i02	VTD410EV	Knee button "hold back device" (NO)

Description: NO = Contact inactive open
NC = Contact inactive closed

- Press the "P" button. F-173
- Press the "P" button.

8.4 Installation or replacement of the sewing drive's control box

Installation of the control box has been taken care of by the Strobel company already at delivery. An installation of the control box therefore needs to be done only after a replacement.



CAUTION!

Before replacing the control box check the Efka- **and** Strobel program number on the old as well as the new control box are the same (see Parameter F-179 and F-762)!



CAUTION!

The replacement of the control box may be done only by an electrician.

When installing the control box ensure, check and set the following:



CAUTION!

Switch the machine off electrically by the main switch S0 and pull the power plug.

- Switch off the machine electrically with the S0 main switch (Fig. 4) and pull the power plug.
- Disconnect all plug-in outlets on the back of the control box.
- Unscrew the bonding function of the control box back (if available).
- Unscrew the control box, replace and screw back on.



CAUTION!

Before replacing the control box check that the electrical connection specifications on the control box's type plate, in particular the network voltage and the frequency are appropriate for your electric network.

- Check the proper assembly of the motor and any accessories used.
- Screw the bonding function of the control box back (if any) back.
- Connect all plug-in outlets on the back of the control box.
- Plug in the power plug, switch the machine on with the S0 main switch, and enter code number "3112".
- Reset/initialise the machine with parameter F-764.
- Set needle positions with parameters F-170 and F-171.

Be sure to observe the chapters of this manual respective to the individual points.

8.5 Replacement of the sewing drive motor



CAUTION!

The replacement of the motor may be done only by an electrician.

When replacing the motor ensure, check and set the following:



CAUTION!

Switch off the machine electrically and pull the power plug.

- Switch off the machine electrically with the S0 main switch (Fig. 4) and pull the power plug.
- Disconnect the two plug-in outlets of the motor on the back of the control box.
- Unscrew the motor, replace and screw back on.



CAUTION!

Before replacing the motor check that the electrical connection specifications on the motor's type plate, in particular the network voltage and output are appropriate for the control's data.

- Check the proper assembly of the motor and the belt protection.
- Connect the two plug-in outlets of the motor on the back of the control box.
- Plug in the power plug, switch the machine on with the S0 main switch, and enter code number "1907".
- Set needle positions with parameters F-170 and F-171.

Be sure to observe the chapters of this manual respective to the individual points.

8.6 Fault messages of the sewing drive AB321A

8.6.1 General information

On the control	On the V810 operating control	Description
A1	InF A1	Pedal is not in pedal position "0" when the machine is switched on.
A2	-StoP-	Run inhibition active.
A3	InF A3	Reference position not set.

8.6.2 Programming functions and values (parameters)

On the control	On the V810 operating control	Description
Jumps back to "0000".	Jumps back to "0000".	Wrong code number entered.
F1	InF F1	Wrong parameter number entered.

8.6.3 Serious status

On the control	On the V810 operating control	Description
E1	InF E1	The external pulse generator (if existing) e.g. IPG..., is defective or not connected.
E2	InF E2	Network voltage too low or period between power-off and -on too brief.
E3	InF E3	Machine blocked or does not reach desired speed.
E4	InF E4	Control fault due to insufficient earth or loose contact.
E9	InF E9	EEPROM defective.

8.6.4 Hardware fault

On the control	On the V810 operating control	Description
H1	InF H1	Commutation transmitter in-line or converter faulty.
H2	InF H2	Defective processor.

Mains connection plan cl. gen. (DC1500/DC1550 with/without sewing machine lamp gen.)

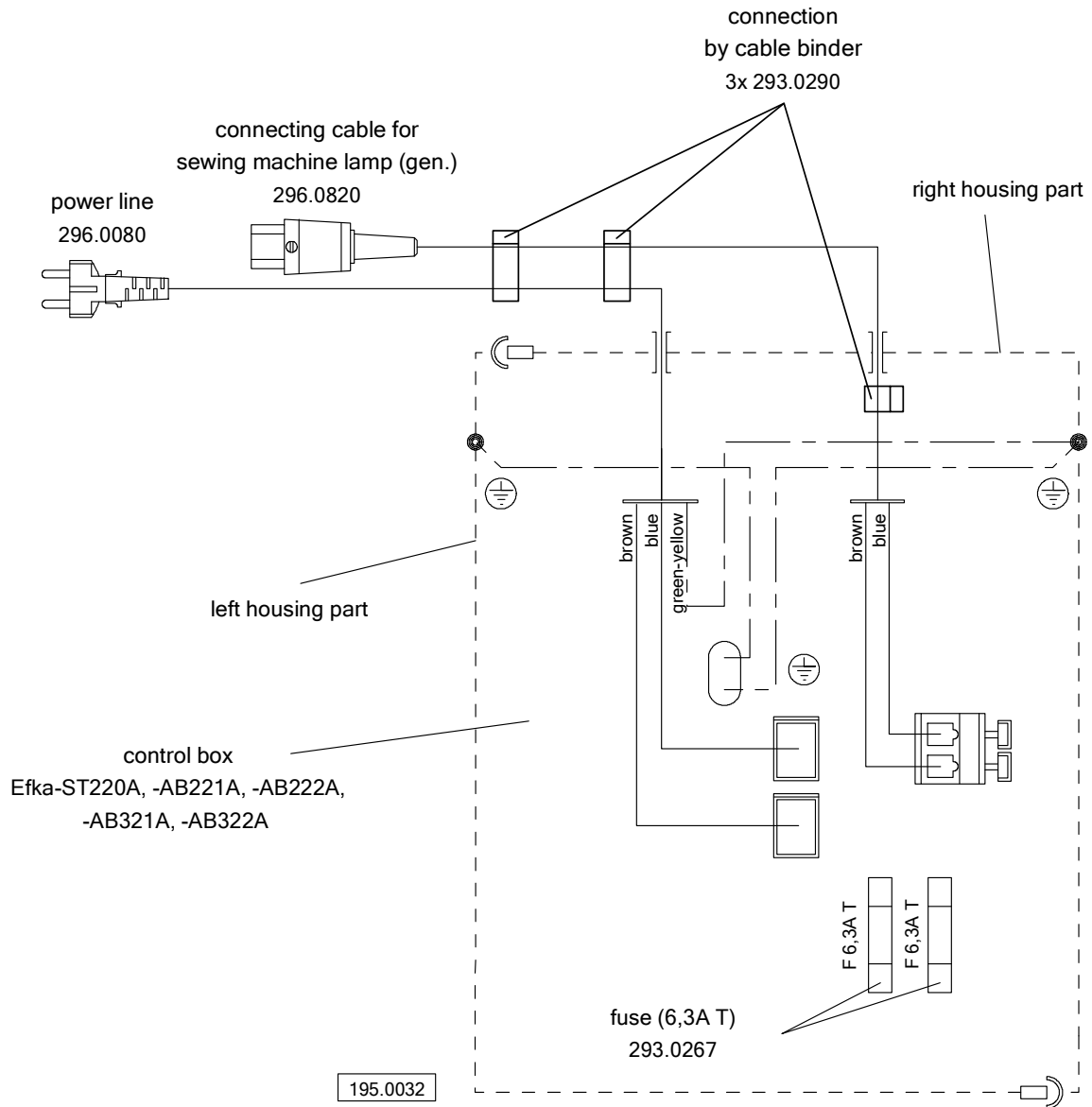

Mains facility connection plan cl. general (DC1500/DC1550 with/without sewing machine lamp gen.)

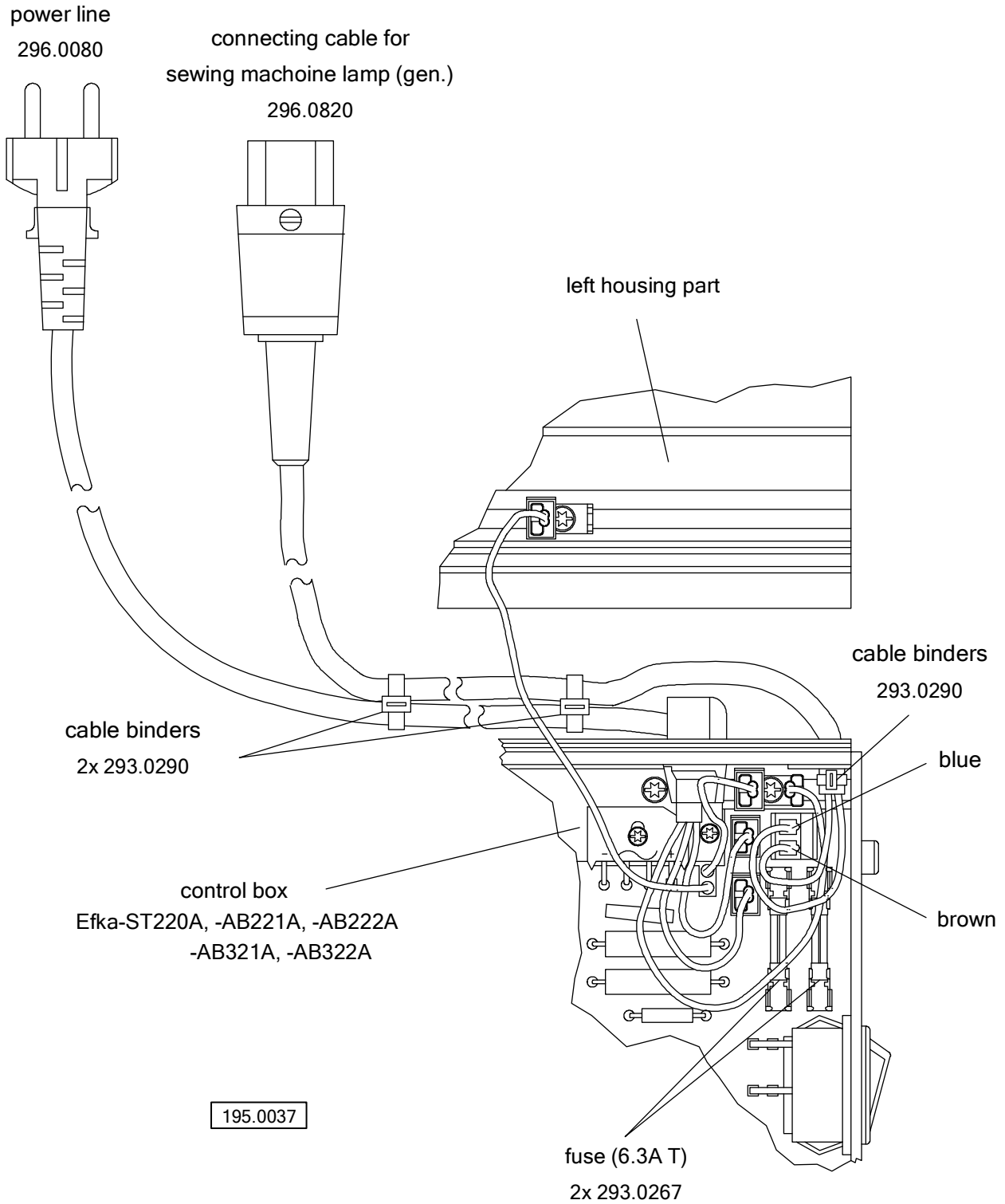

Electrical connection plan cl. VTD410EV as of version 1 (DC1550-AB321A)

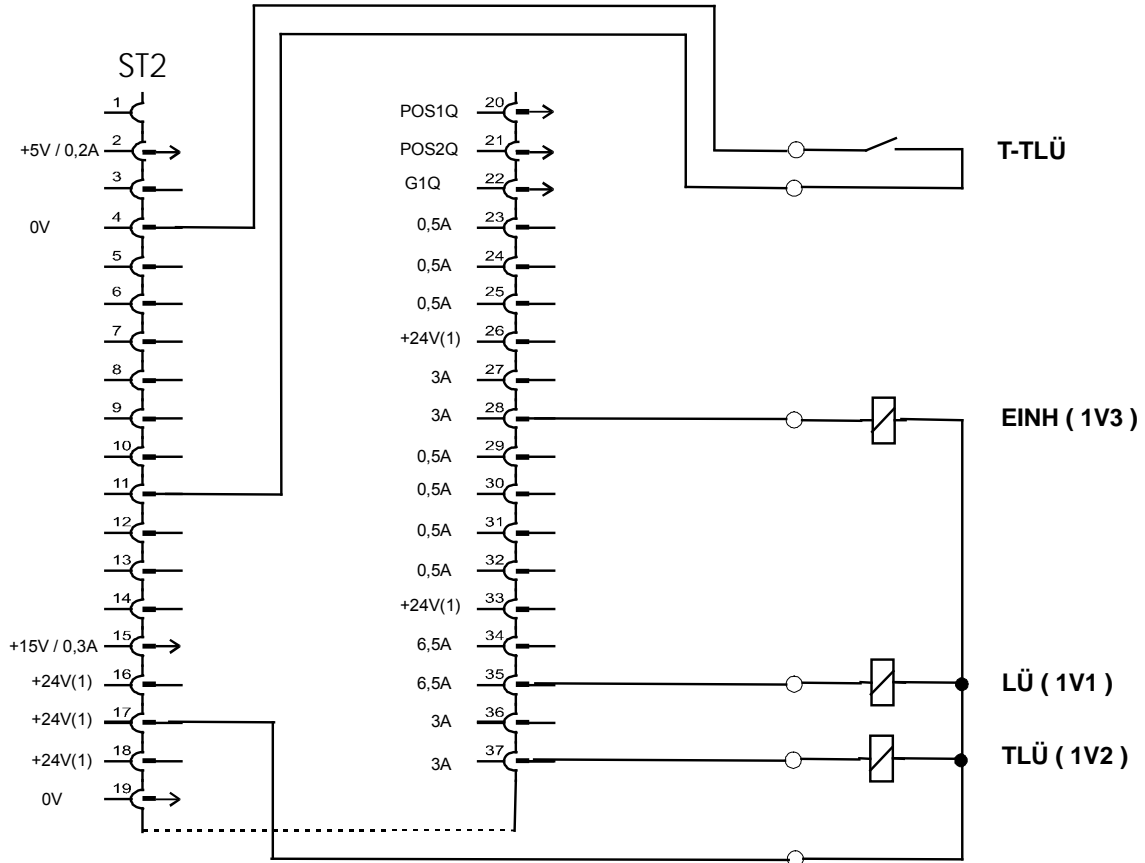

Control box Efka drive

(1) Nominal voltage 24V, idle voltage max. 30V

Designation Strobel operating manual	Designation Efka operating manual	PIN 37 pin Sub-D	Colour code connection cable
Lifting (LÜ)	Lifting (LÜ)	35 17	white brown
Partial lifting (TLÜ)	Output 1 (M1)	37 (17)	green (brown)
Hold back (EINH)	Output 2 (M2)	28 (17)	pink (brown)
Partial lifting button (T-TLÜ)	Input 2 (IN2)	11 4	green white

Strobel-Parameter list (DC1550-AB321A)

Machine class		Parameter													
	F-290	Modus	00 37	00 14				05	03						
	F-291	Plug-in strip number for V810 operating control	00	00	14										
	F-019	Lifting with pedal position "-1"	0	0	4			1							
	F-111	Maximum speed n2-	n2_	1800		min-1	1500								
	F-201	Switch delay of the lifting at pedal position "-1"	020	020	500	ms	500								
	F-202	Starting delay after the lifting signal (LÜ) switches off	000	000	500	ms	400								
	F-203	Full drive time of the lifting	000	000	600	ms	500								
	F-204	Holding force (continuous duty) of the lifting	F-254	1		%	60								
	F-236	Lifting mode	0	0	2		2								
	F-254	Upper limit continuous duty for lifting (F-204)	001	001	100		100								
	F-288	Delay time till lifting On	000	000	2550	ms	200								
	F-741	Threading speed	070	070	390	min-1	100								
	F-742	Positioning speed n1	070	070	390	min-1	200								
	F-751	On-time of the partial lifting	0000	0000	2550	ms	200								
Setting range															
Unit															
VTD410EV at version 1															

Stand: 27.03.13 - PT_AB321A_VTD410_130327

Bl.Nr. 348.23.19

Teile Nr.	Benennung
396.0440	Für DC1550-AB321A Nähantrieb
296.0440	KI. VTD410EV:
298.0069	Anschlußleitung kpl. für Lüftung, Teillüftung und Einhalten bestehend aus: Anschlußleitung Knietaster kpl.

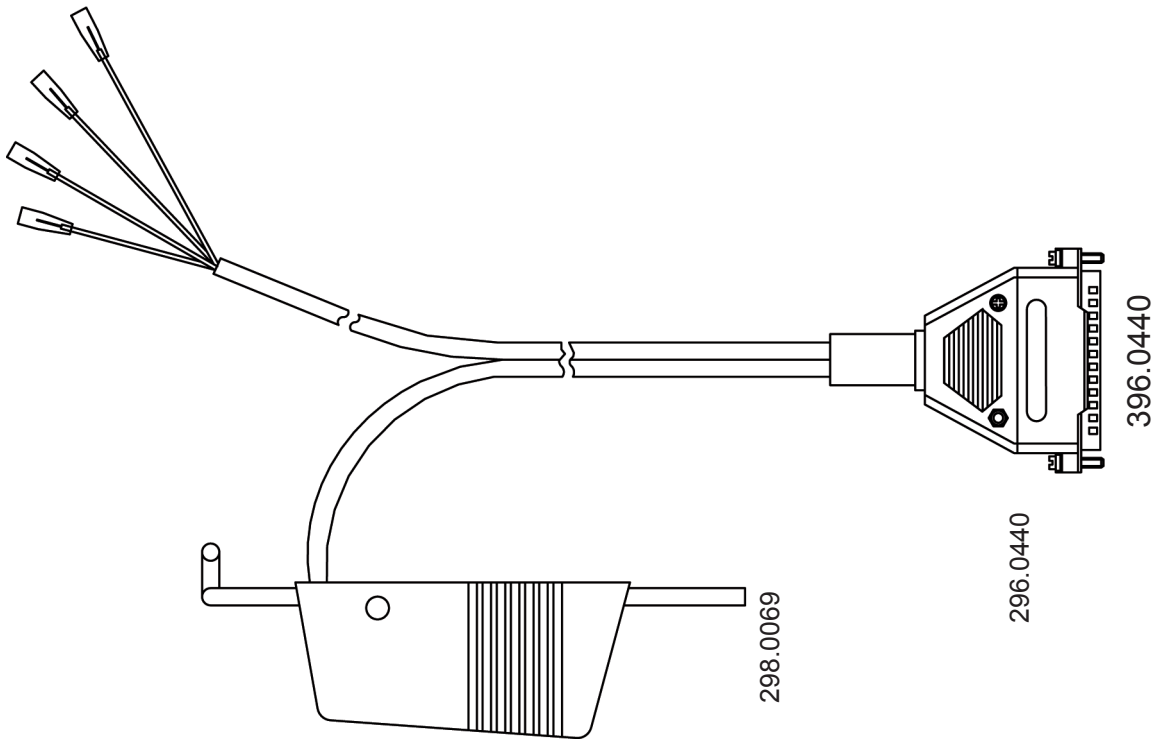

Änderungen vorbehalten

Für DC1550 Näh Antrieb

Untertischmontagesatz verstärkt:
DC 15.. bestehend aus:
Befestigungsfuss mit Masseklemme,
Lasche kpl., Riemenschutz kpl.,
4 Rechteckmuttern, Satz Schrauben,
Keilriemenscheibe Ø58

Federring 8,1
Scheibe R9
Sechskantschraube M8x35

Kl. VTD410EV/-SEPC1:

Keilriemen 10 x 950

298.0693

164.0046
169.0035
173.0803

141.0023

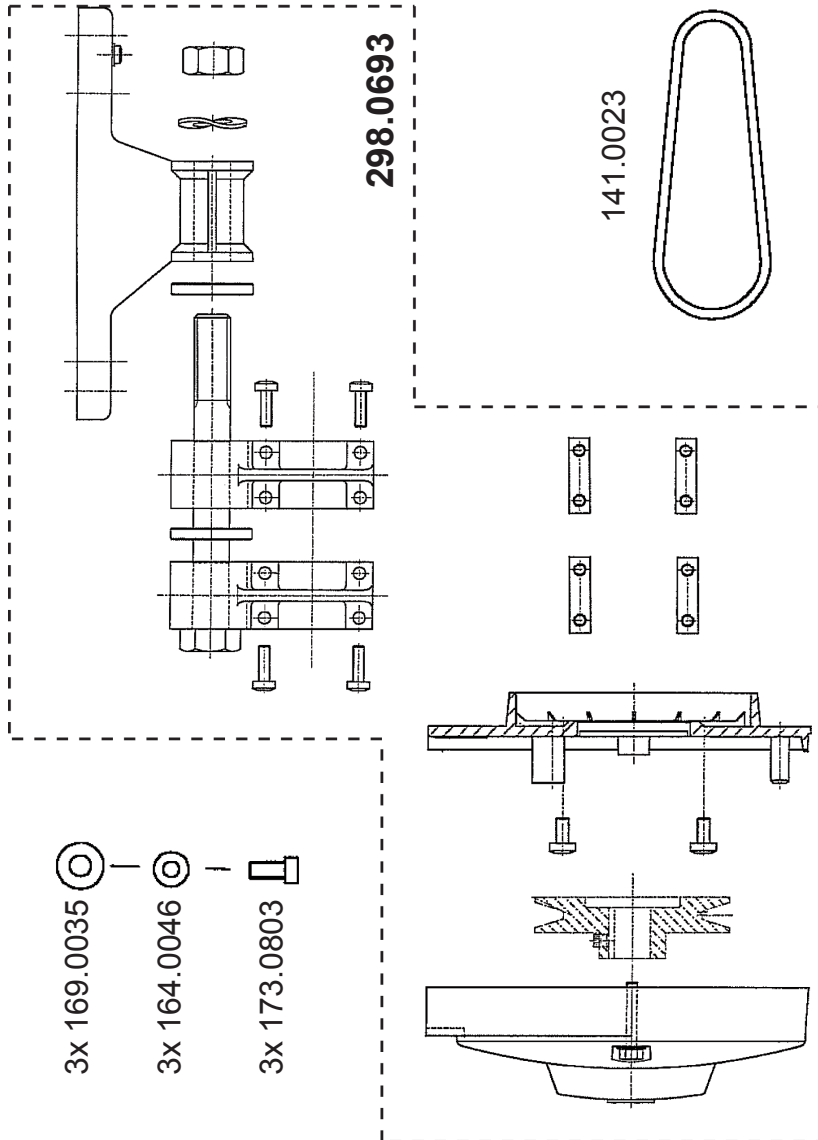

Teile Nr.	Benennung
Für DC1550-AB321A Nähtrieb	
116.0517	Befestigungswinkel f. Sollwertgeber
233.0846	Zugstange
164.0003	Federscheibe
171.0505	Zylinderschraube m. Iskt. M5x10
178.0055	Spanplattenschraube 4x20
178.0077	Spanplattenschraube 5x25
192.0004	Warnschild
293.0080	Schuko-Stecker
293.0088	Kabelschelle
293.0089	ISO-Druckschelle
293.0209	Kabelschelle
293.0722	Kabelbinder
293.0930	Kabelschelle
298.0542	Bedienteil V810
298.0562	Sollwertgeber EB301A
298.0691	dc Grundmotor DC1550
398.0692	KI. VTD410EV Steuerkasten AB321A-N206

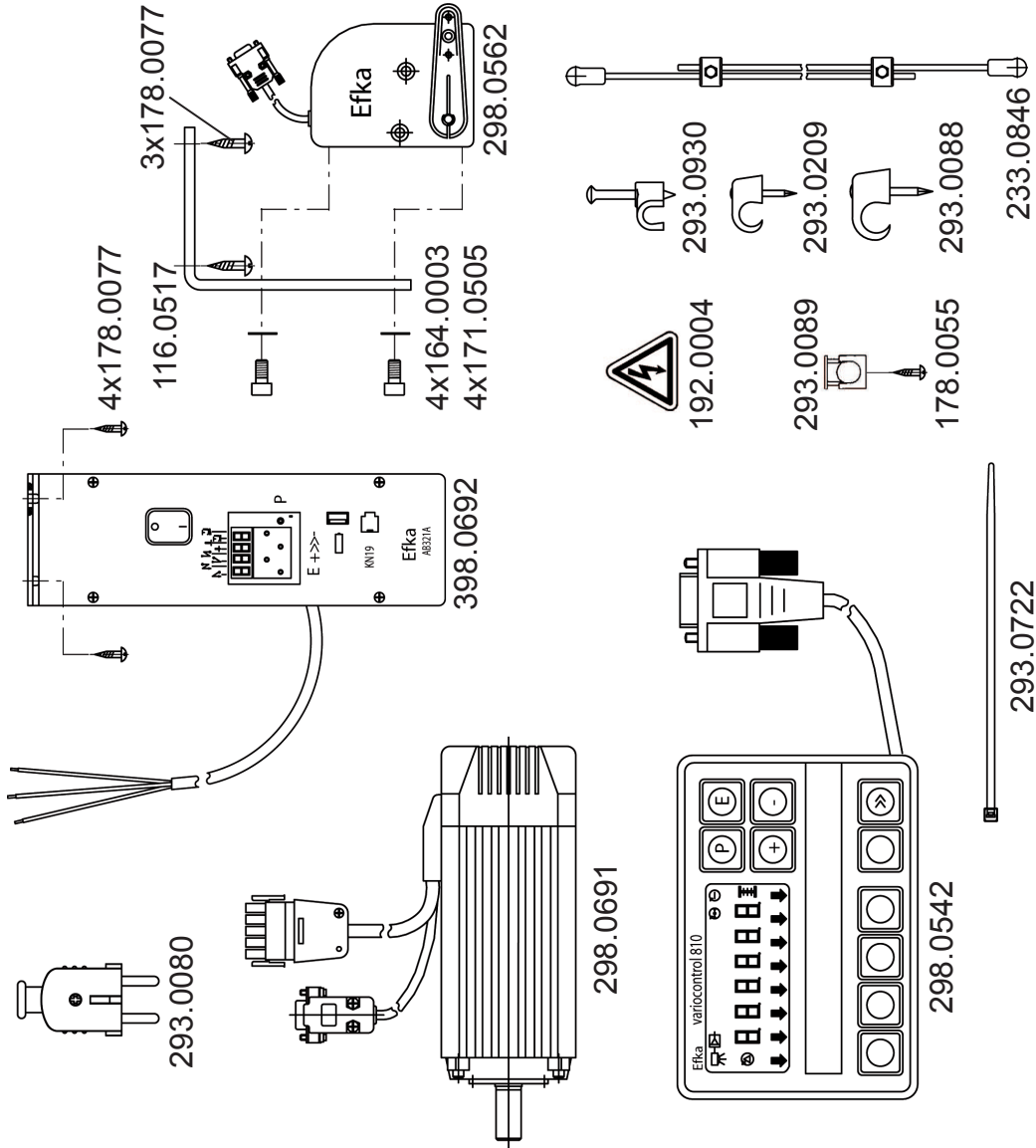

Änderungen vorbehalten

Teile Nr.	Benennung
Für DC 1500/DC1550 Nähantrieb	
298.0620	Impulsgeber Typ: IPG 001
Kl. 120:	
244.0299	Flansch kpl. bestehend aus:
144.0299	Flansch
175.0515	Gewindestift M5x5
Kl. 120, 310, 3100, 3200:	
175.0609	Gewindestift M6x50
169.0033	Scheibe 6,4
179.0628	Sechskantmutter M6
Kl. 218, 325, 327:	
133.0784	Gewindestange M6x105
169.0033	Scheibe 6,4
179.0628	Sechskantmutter M6
Kl. 103-258, 141, 142:	
133.0395	Stange Ø6x130
Kl. 180:	
133.0894	Stange
179.0628	Sechskantmutter M6
Kl. VTD410EV/-SEPC1:	
175.0609	Gewindestift M6x50
169.0033	Scheibe 6,4
179.0628	Sechskantmutter M6

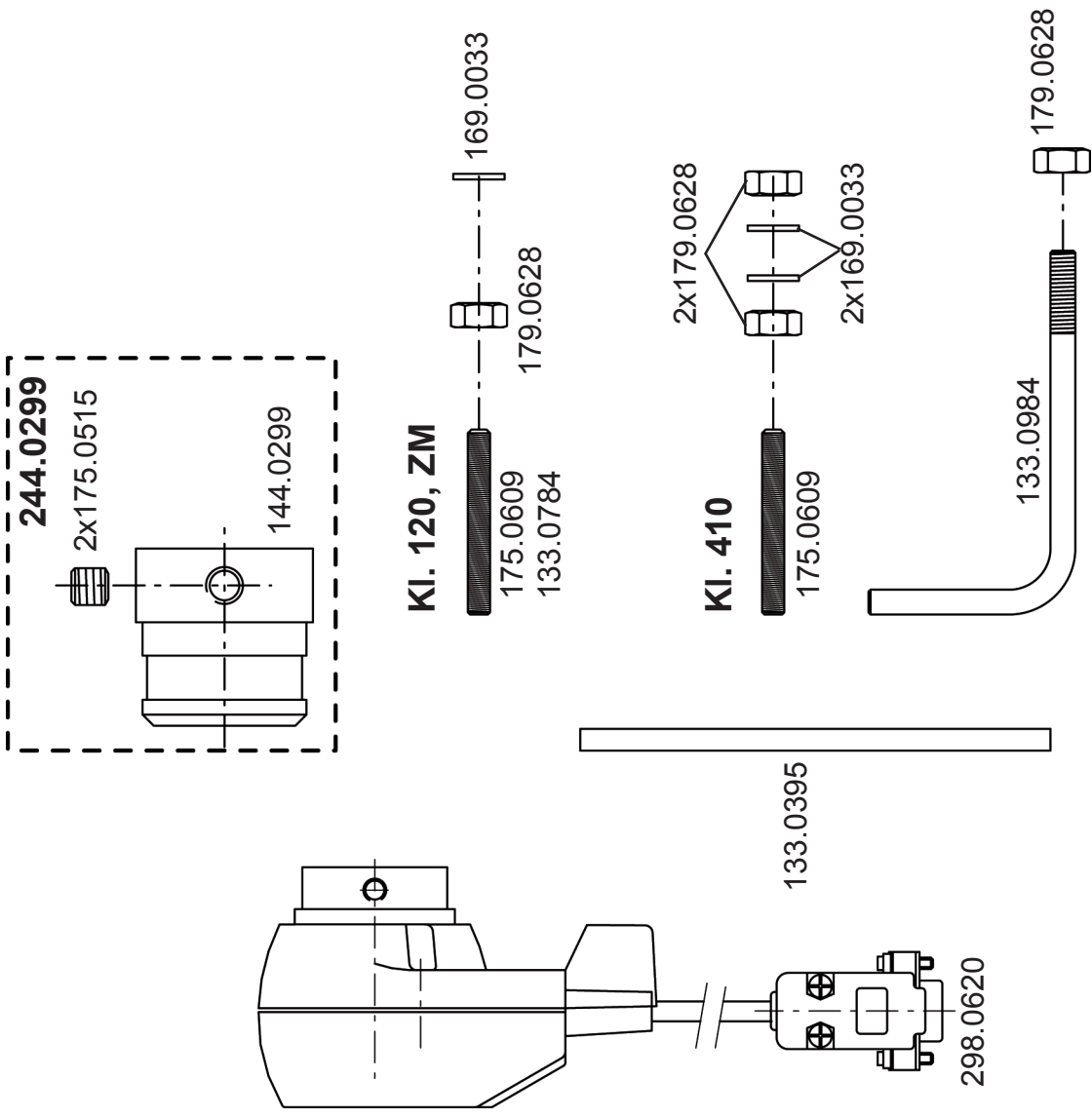

Änderungen vorbehalten

Masse-Anschluss Oberteil

Kl. allg.

Teile Nr.	Benennung
164.0005	Federring
169.0026	Scheibe B4,3
171.0403	Zylinderschraube m. Iskt. M4x10
193.0982	Massezeichen
296.0817	Masse-Anschlussleitung (grau/Länge: 800 mm)
296.0818	Masse-Anschlussleitung (grau/Länge: 400 mm)
197.0277	Kontaktscheibe

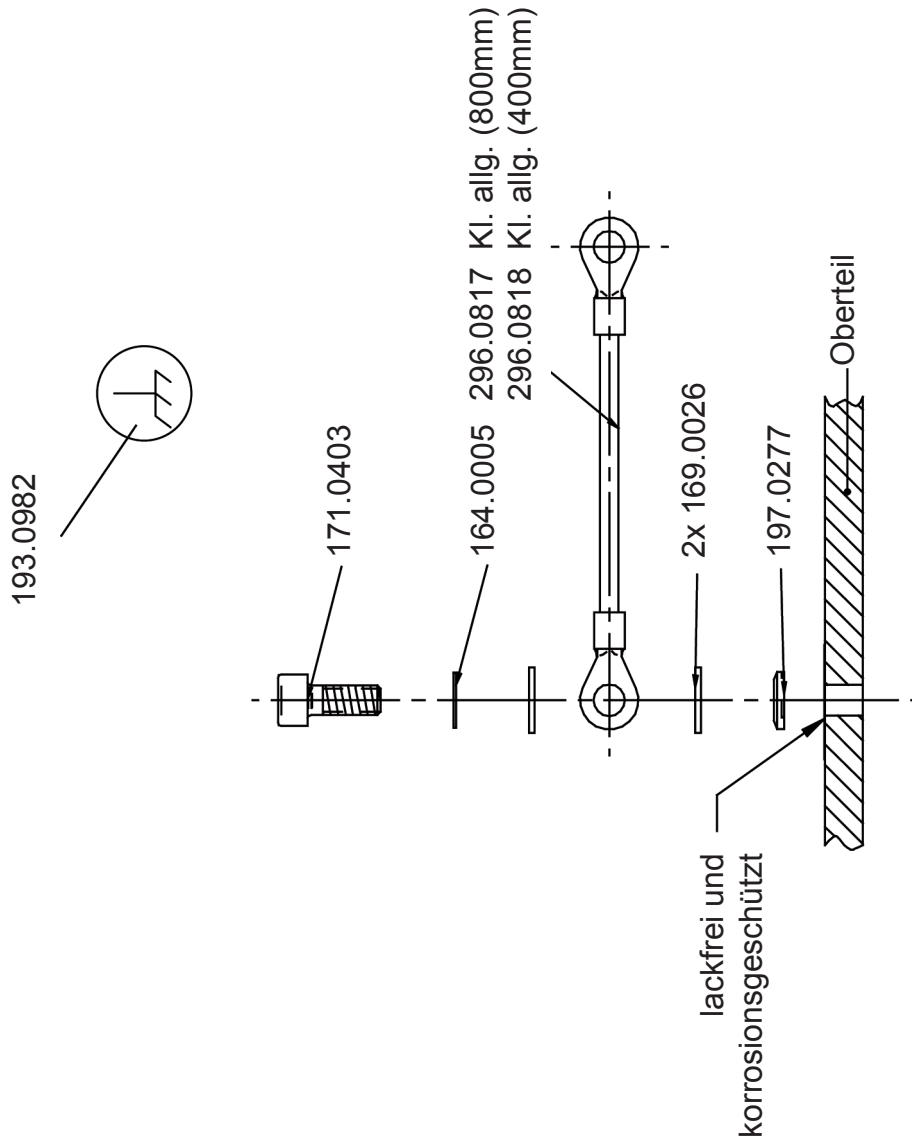

Und wir können noch mehr für Sie tun!

Unser Lieferprogramm bietet für jede Branche und jegliche Anforderung genau die richtige Problemlösung.

And we can do a lot more for you!

Our range offers the correct problem solution for every branch and for all requirements.

■ Für die Bekleidungsindustrie:

Ein- und Zweifaden-Hochleistungs-Saummaschinen

Doppelblindstich-Saummaschinen

Zweifaden-Blindstich-Staffiermaschinen

Roll- und Flachpikiermaschinen

Pikier-Automat

und

weitere Spezial-Nähmaschinen

■ *For the clothing industry:*

Single and two thread high performance hemming machines

Bluff edge hemming machines

Two thread blind stitch felling machines

Roll and flat padding machines

Automatic lapel padding machine

and other special sewing machines

■ Für die Schuhverarbeitung:

Einfaden-Überwendlichmaschinen mit und ohne Differentialtransport

■ *For the shoe industry:*

Single-thread overseaming machines with and without differential feed

■ Für Kürschnereien und Pelzkonfektion:

Pelzschnellnäher

Pelzpikiermaschine

Futterstaffiermaschine

■ *For the fur industry:*

Rapid fur sewing machines

Fur padding machine

Lining felling machine

■ Für Heimtextilien:

Ein- und Zweifaden-Blindstichmaschinen

■ *For the home textiles industry:*

Single and two thread blind stitch machines

■ Für die Polsterverarbeitung:

Ein- und Zweifaden-Überwendlichmaschinen

Ein- und Zweifaden-Blindstichmaschinen

■ *For the upholstery industry:*

Single and two thread overseaming machines

Single and two thread blind stitch machines

■ Für die Konfektion technischer Textilien:

Ein- und Zweifaden-Überwendlichmaschinen

■ *For the processing of technical textiles:*

Single and two thread overseaming machines

Noch Fragen?

Dann rufen Sie uns an, schreiben Sie uns oder kommen Sie einfach bei uns vorbei.

Sie können jederzeit weitere Informationen über unsere Produkte anfordern oder die Strobel-Nähmaschinen in unserem Ausstellungsraum live erleben. Wir freuen uns auf Sie!

Any further questions?

Then phone, write or simply come and see us. You can have further information about our products at any time, or experience the Strobel machines live in our show room. We're looking forward to meeting you!

STROBEL

Spezialmaschinen GmbH

Postfach 1242
82168 Puchheim
Siemensstraße 3
82178 Puchheim
DEUTSCHLAND

www.strobel.biz
Telefon: +49 89 80096-0
Telefax: +49 89 80096-190