



INDUSTRIAL SEWING MACHINE

MODEL

PLK-G-CU-20

TECHNICAL MANUAL

Control Unit

[1] For safe use	[1]-1
[2] Precautions for use	[2]-1
[3] Installation	[3]-1
[4] Names of each part, wiring and grounding	[4]-1
[5] Confirmation	[5]-1
[6] Initial Settings of System Software (Model/Language Settings)	[6]-1
[7] Timing chart	[7]-1
[8] Customized input/output	[8]-1
[9] Input/Output signal	[9]-1
[10] What happened? Could it be an error?	[10]-1
[11] Several power supply	[11]-1
[12] Unit wiring diagram	[12]-1
[13] Connectors layout	[13]-1
[14] Pin number of connectors	[14]-1
[15] Wiring diagram inside control box	[15]-1
[16] Specifications	[16]-1

Thank you for purchasing the Mitsubishi industrial sewing machine PLK-G Series. Please read this technical manual before starting to ensure correct and long-term use.

- * The contents of this manual may not be reproduced in part or whole.
- * The contents of this manual are subject to change without notice.
- * An utmost effort has been made to cover all points of operation in this manual. Contact Mitsubishi if you have any questions regarding the contents.

COPYRIGHT(C)2015 MITSUBISHI ELECTRIC CORPORATION

[1] For safe use

■ For safe use

Always observe the following matters to safely use the Mitsubishi industrial electronic sewing machine PLK-G Series.

Before starting

Before using this control unit, read all of the technical manuals carefully, and correctly use the unit following the manual. Also read the "Mitsubishi Industrial Sewing Machine Technical Manual <Sewing Machine Head>" for details on the general configuration and sewing machine head.

Application and purpose

This control unit is designed to drive and control the Mitsubishi industrial electronic sewing machine PLK-G Series. Do not use this control unit for other applications or purposes. Do not use this control unit until it has been confirmed that safety measures have been accurately taken for the installed electronic sewing machine head section.

Working environment

Please use this control unit in the industrial setting only. And do not use this control unit in the following type of environment.

(1) Power voltage

* Where the voltage fluctuation exceeds $\pm 10\%$ of the rated voltage.

* Where the specified power capacity (refer to technical manual [Control unit] page [4]-2 "5. Power capacity") cannot be ensured.

(2) Magnetic noise

* Where strong fields or magnetic fields are generated, such as near a high-output high frequency oscillating machine or high frequency welder.

(3) Temperature and humidity

* Where the ambient temperature is 35°C or more and 5°C or less.

* Where the unit will be subject to direct sunlight, or outdoors.

* Near sources of heat, such as heating appliances.

* Where the relative humidity is 45% or less, or 85% or more, and where dew may condense.

(4) Atmosphere

* In an atmosphere containing dust or corrosive gases, etc.

* In a flammable gas or explosive environment.

(5) Vibration

* If excessive vibration could occur when installed on the sewing machine, separately install the control box.

■ Installation

Control box

Correctly install the control box according to this manual.

Accessories

Always disconnect the control unit from the main power supply before installing the accessories listed in this manual. (Turn the power switch OFF, and disconnect the plug from the socket (power supply line).)

Cable

(1) Lay the connection cables so that excessive force will not be applied during operation. Do not excessively bend the cables.

(2) Cables laid near operating machine sections must be separated by at least 25mm.

(3) Before connecting the power cable to the control box, confirm that the power voltage matches the specifications given on the control box's rating nameplate and factory shipment voltage nameplate. Connect the cable to the indicated positions, and then supply the power. When using a power unit, connect the cable to the power unit and supply the power. In addition, when using a power unit, confirm that the power voltage matches the specifications given on the power unit's rating nameplate. Turn the power switch OFF before making any connections.

Grounding

Always ground the power cord's grounding wire.

Enclosed units and accessories

Connect the electrical enclosed units and accessories only to the positions indicated in the manual.

Removal

- (1) Always turn the power switch OFF and disconnect the plug from the socket (power supply line) before removing the control box.
- (2) Do not pull out the cord when disconnecting the plug. Always hold the plug receptacle when disconnecting the plug.
- (3) Note that a high voltage is applied inside the control panel, **so always turn the power OFF and wait at least ten minutes before opening the control box cover.**

■ NOTICE CONCERNING CE MARKING

- (1) Electronic sewing machine PLK-G series are applied to CE conformity marking by installing the exclusive device [PLK-G-CE].
When the products are used in the EU region, these devices are necessary to be installed.
- (2) Electronic sewing machine should be use limited to the industrial areas even though above-mentioned countermeasure is done.
[Warning] Use in residential areas may cause interference.

■ Maintenance, inspection and repairs



- (1) Follow this manual when carrying out maintenance or inspections related to this control unit.
- (2) This unit must be repaired, serviced and inspected only by a worker that has received special training.
- (3) Always turn the power OFF before replacing the needle or bobbin, etc., on the head.
- (4) Use genuine replacement parts for repairs and maintenance.

■ Other safety measures



- (1) Keep fingers away from all moving machine parts (especially around the sewing machine needle, etc.).
- (2) Never drop the control unit, or place objects in the clearances.
- (3) Do not operate the sewing machine without the protective parts such as the cover, or protection devices such as the safety breaker.
- (4) If any damage is observed in the control unit, if the unit does not operate correctly, or if the operation is suspicious, always suspend operation. Only operate the machine after the supervisor has adjusted, repaired or inspected the machine.
- (5) The user must not make improvements or changes without instruction from Mitsubishi.



■ Caution displays and danger displays

- (1) In this manual, the dangers and danger levels that arise with incorrect handling are classified using the following displays.

 Warning	The warning display shows that incorrect handling can lead to death or serious injuries.
 Caution	The caution display shows that incorrect handling can lead to injuries or damages to your house, household goods, and others.

- (2) The meanings of these symbols are as follows.

	This symbol indicates that the instructions must be followed.
	This symbol indicates hot temperature requiring caution.
	This symbol indicates a prohibited action.

	This symbol indicates an electrical hazard or caution (electric shock caution).
	This symbol indicates that ground wire connection is required.

- * Always deliver this manual to the end user.
- * Store this manual nearby where it can be referred to when necessary.

[2] Precautions for use

Warning

1. Do not place foot on the foot switch when turning the power ON.

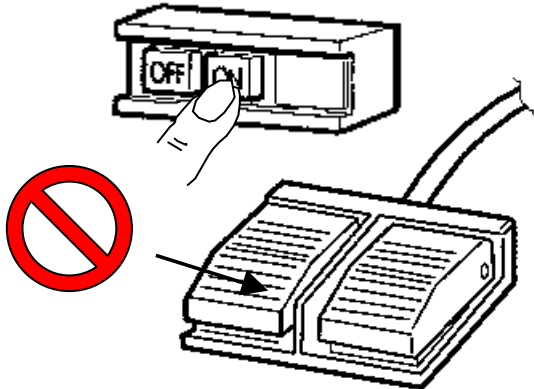

2. Always turn the power OFF when leaving the sewing machine.

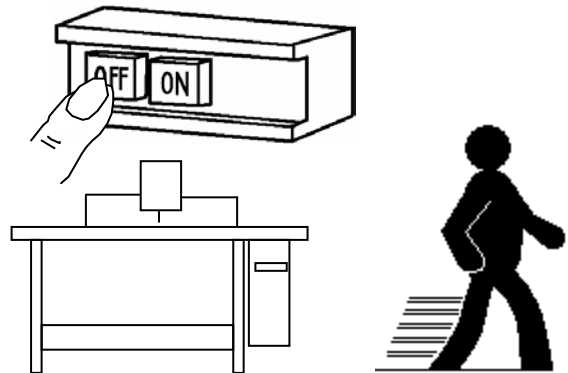

3. Do not inspect the control circuit with a tester.

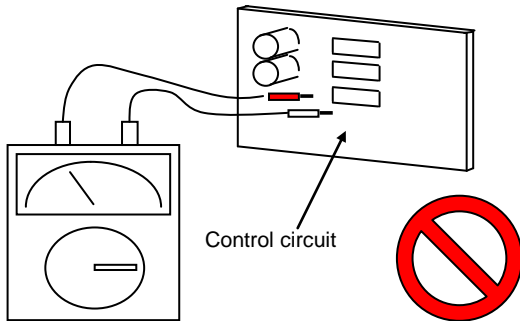

The tester voltage could be applied on the semiconductor parts, and cause damage.

4. Always turn the power switch OFF before tilting the sewing machine head, replacing the needle, or passing thread through the needle.

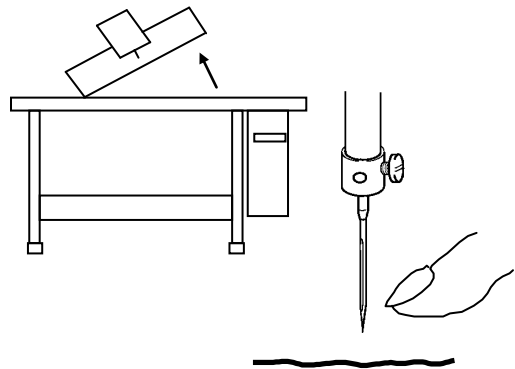

5. Always ground the grounding wire.

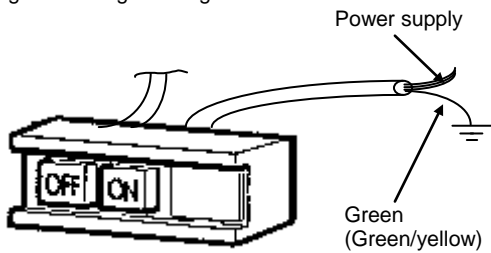

Always ground the provided grounding wire (green(green/yellow)).

6. Do not use excessive wiring.

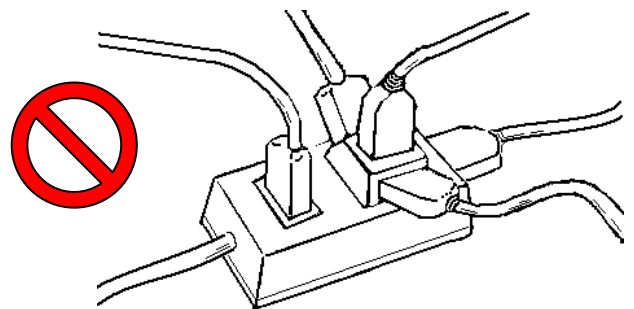

7. A high voltage is applied inside creating a hazardous state, so always turn the power OFF and wait ten minutes before opening the cover.

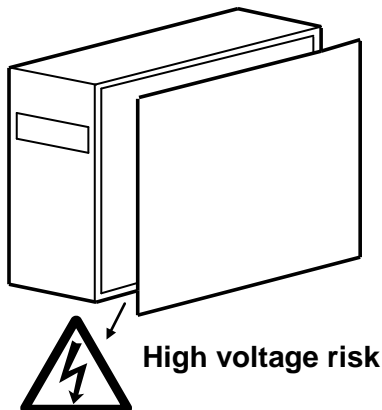

8. Radiation fins and other parts may be hot. Do not touch the parts.

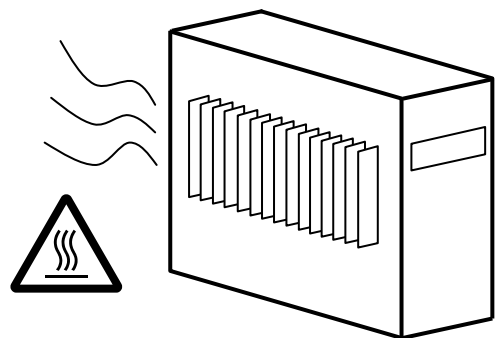

9. The sewing machine will coast to a stop when the power is turned OFF or a power failure occurs during sewing machine operation.
10. Always align the connector shape and direction, and securely insert the connector.
11. If the position detector's connector dislocates, or the sewing machine is completely locked, the motor will be turned OFF automatically for a set time to prevent burning. (Note that the motor may not turn OFF if there is incomplete locking or an overload.) When the fault has been recovered, turn the power OFF and ON once to resume normal operation. The same type of operation will take place if a detector fault or disconnection occurs.

12. Use the machine away from strong noise sources such as high frequency welders.

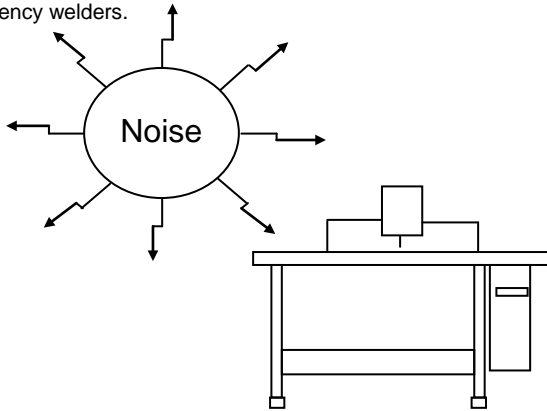

13. When connecting the external switch to an optional connector, etc., keep the signal wire as short as possible. A long wire could cause malfunctions.

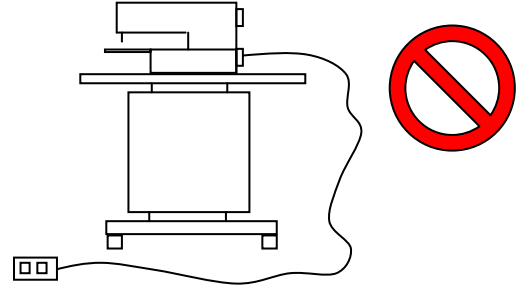

Use a shielded wire for the signal wire when possible.

14. If the fuse blows, remove the cause, and replace the blown fuse with one having the same capacity.

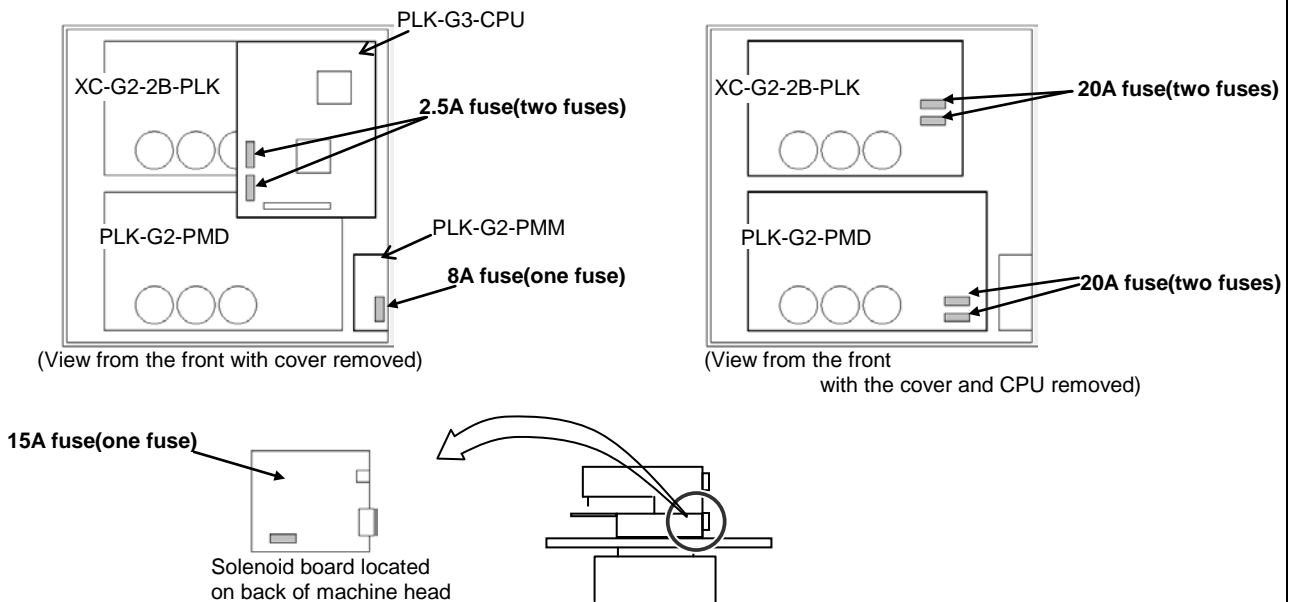

15. Attention when power supply is turned on again

Please make sure not to turn on the power supply switch until after the LED on the front panel of the control box has completely turned off.

(Please do not turn on the power supply again while displaying the screen of the operation panel.)

* Please note that if power supply is turned on again while LED still turns on, clamp outputs (O4, O5 port) may go down.

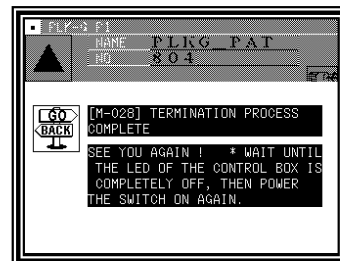

16. When the value of the sewing area limit is changed or the limit setting is deactivated, note the collision and take care safely. Also when using it outside the range where the mechanism can be operated, it can not assume the responsibility for all problems caused by it.

[3] Installation

1. Installing the control box

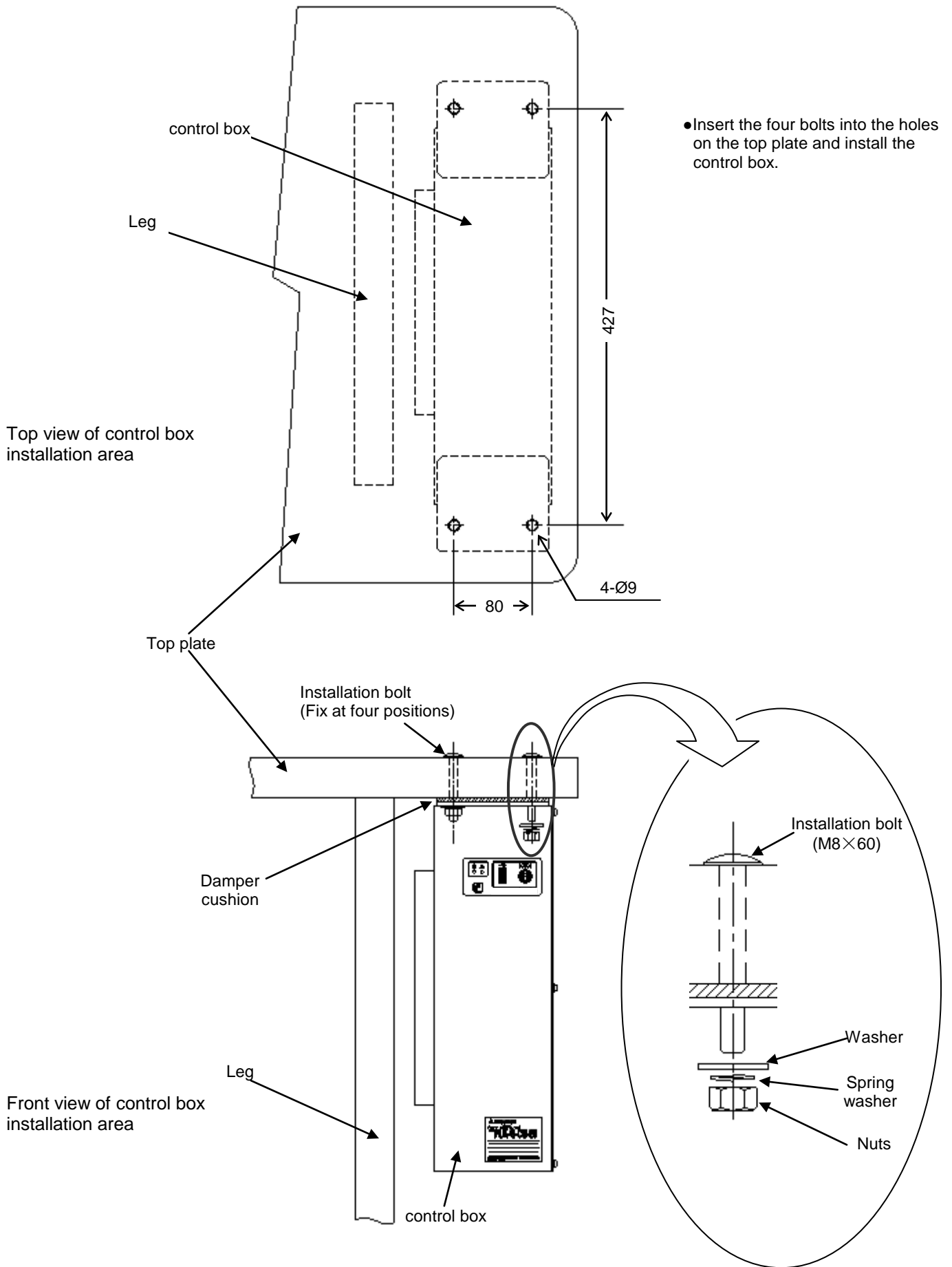

[4] Names of each part, wiring and grounding

1. Front side

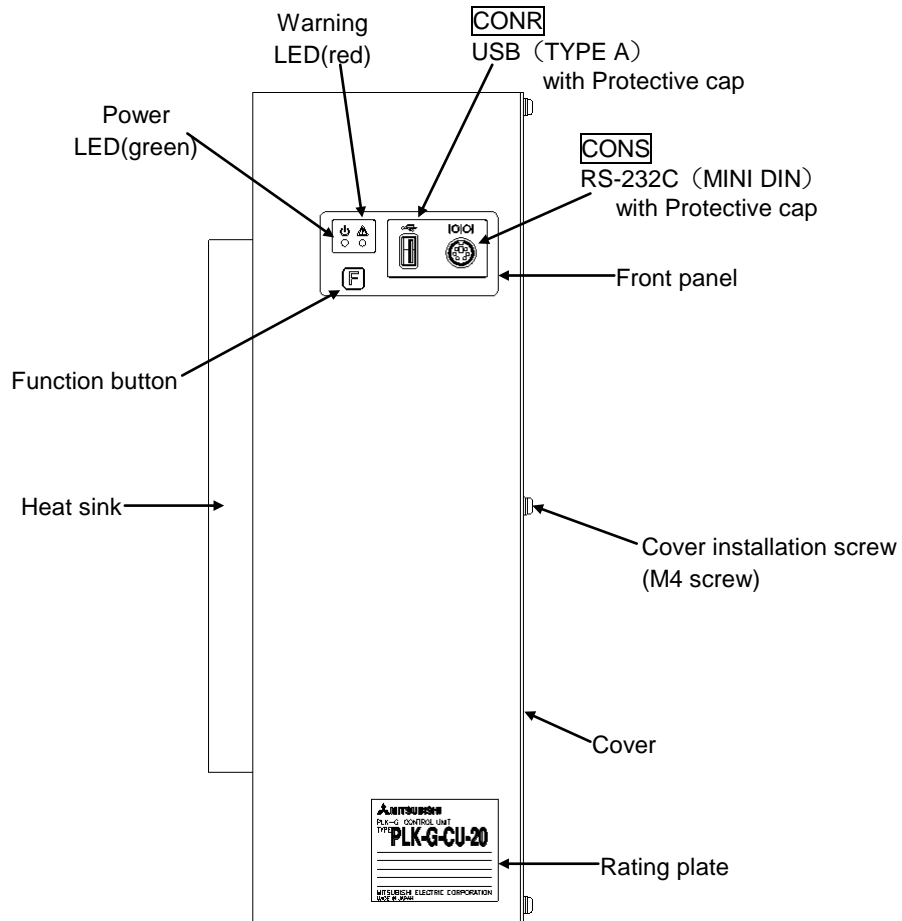

2. Back side

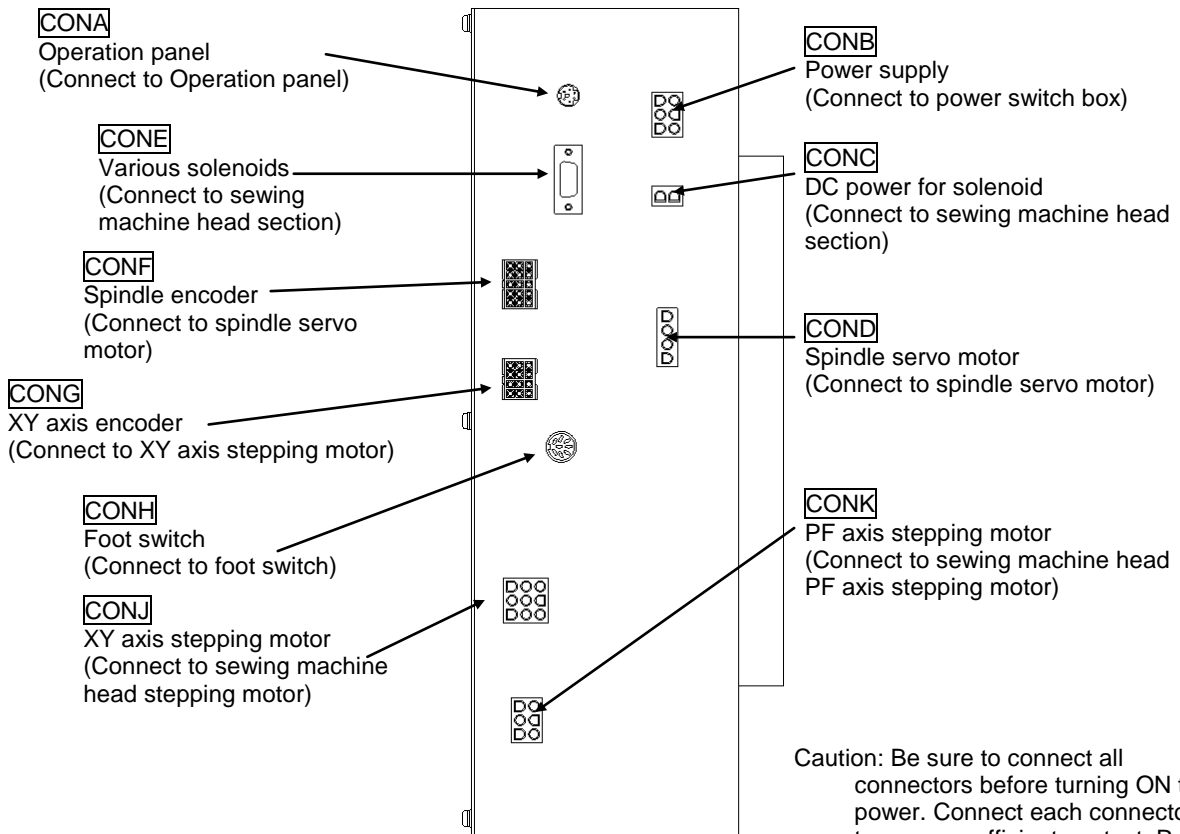

3. Connecting the power connector

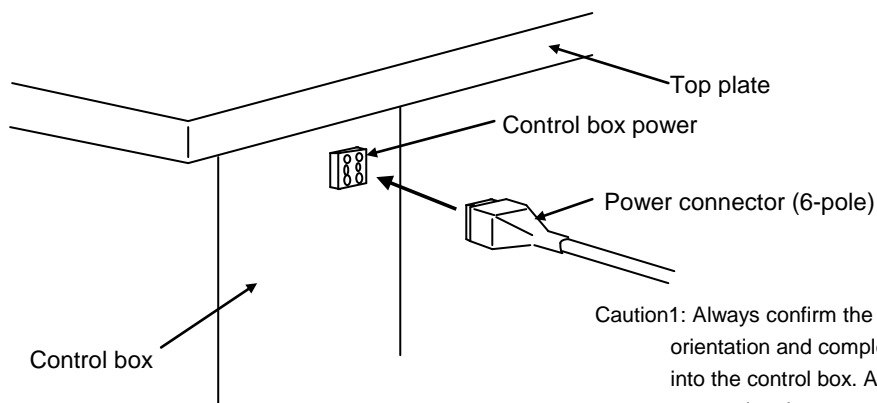

Caution1: Always confirm the connector shape and insertion orientation and completely insert the power connector into the control box. Always turn the power OFF before connecting the connector.

Caution2: Please do not bundle the power cable and other cables together. It may cause of malfunction by the influence of the power supply noise etc.

4. Connecting the 3-phase power supply

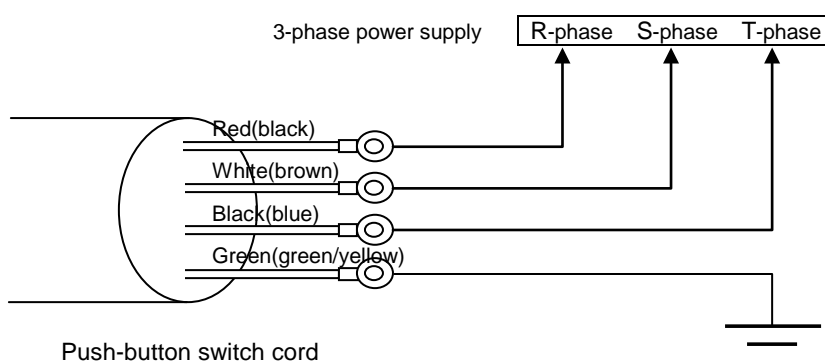

Warning



Always connect the green wire to the grounding terminal.

Consult with your electrician for details on the grounding wire.

5. Power capacity

Use a fuse or safety breaker on the power supply.

Power supply	Recommended current capacity value
3-phase 200V	10A

6. Using the 3-phase 200V control box with single-phase 200 to 220V

Connect power supply to the "red" and "white" lead wires for the push-button switch. The black wire is not used, so insulate it by wrapping insulation tape, etc., around it. Always ground the green grounding wire.

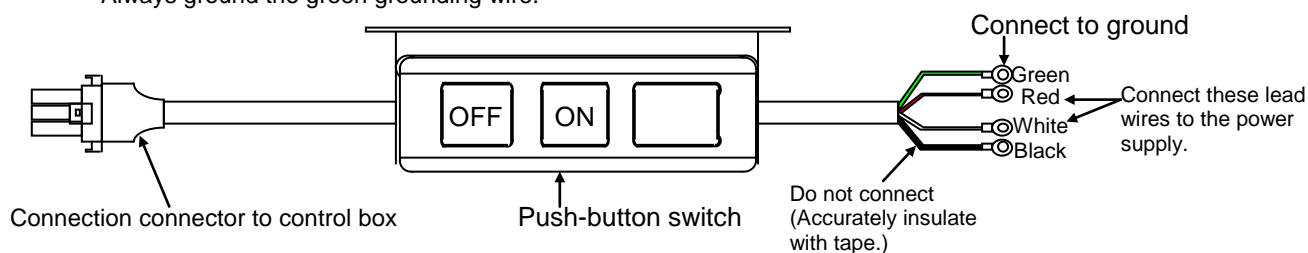

[5] Confirmation

1. Before turning the switch ON

(1) Are the power and capacity correct?

(2) Are the connectors correctly inserted? (Refer to "[12] Unit Wiring Diagram.")

- * Power connector from push-button switch
- * Connector for connection with sewing machine
- * Motor connector
- * Motor encoder connector
- * Foot switch connector
- * Other connectors (solenoid, etc.)

(3) Does the hand pulley turn easily?

2. After turning the switch ON

(1) Is the front panel power LED (green) on?

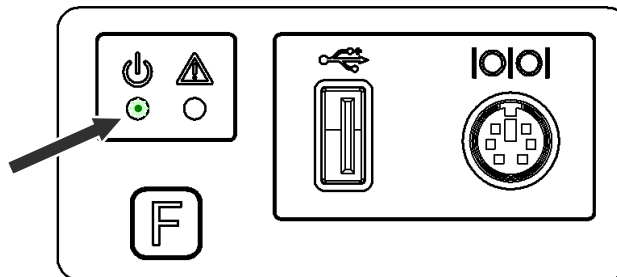

(2) Is the front panel warning LED (red) on or flickering?

For actions to be taken when the warning LED (red) is on or flickering, refer to "[10] What Happened? Could it Be an Error?"

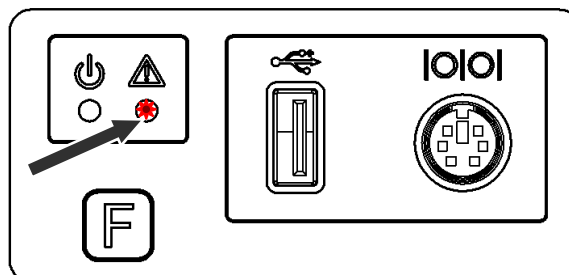

(3) Is there any heating, odors or abnormal noise from the motor or control box?

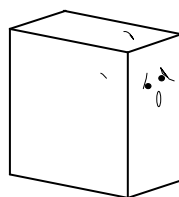

Turn the sewing machine OFF and contact your dealer if there is any heating, odors or abnormal noise.



- When you turn ON the power, a click noise comes from inside the control box. This noise is not abnormal.

[6] Initial Settings of System Software (Model/Language Settings)

1. Model/Language Settings



The model to be used and the language to be displayed need to be set. When you turn on the machine power with the system in an initial state, the "Model/Language Setting" screen appears. Perform the procedures below.

(1) When the power supply is turned on first time, [Model/Language setting] screen is displayed.

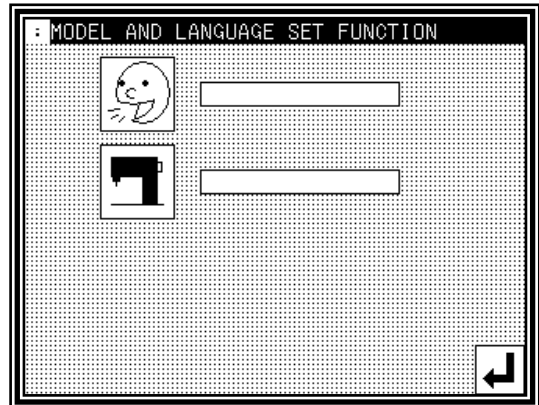
- ▶ For language setting, press .
- ▶ For model setting, press .



(2) Language setting

- ▶ press .
- ▶ Choose Language button, then press .

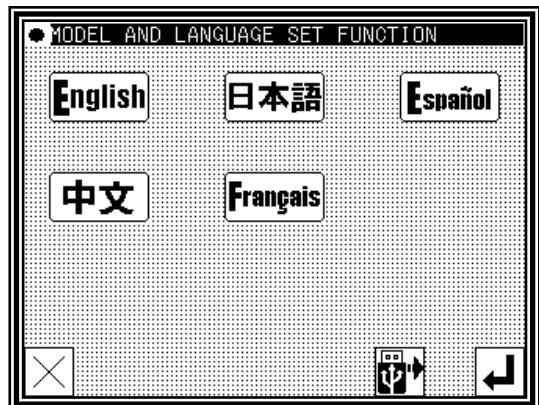

• How to select the multi-language

- ▶ Save the system data in a USB memory.
(Refer to page[10]-8 [System data save to USB memory])
* Copy the [ PLKG_system] folder where the installed system data are included, into the root directory of USB memory.

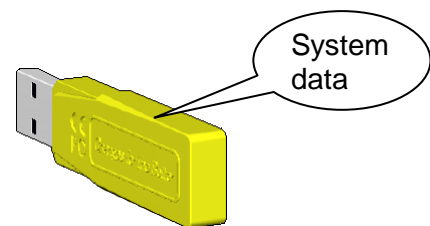

- ▶ Insert the USB memory, then press .

* If  does not appear when insert the USB memory, the system software does not support multi-language. Please consult with your local representative about the system software that supports multi-language.

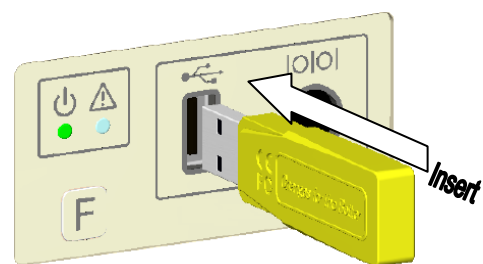

▶ **日本語** button is changed to **OTHER** button.

▶ Press **OTHER**.

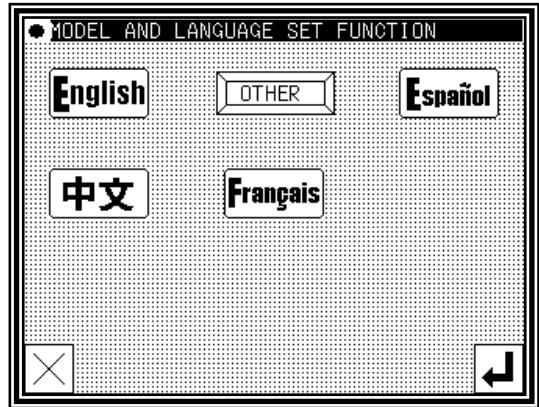

▶ Choose Language button, then press .

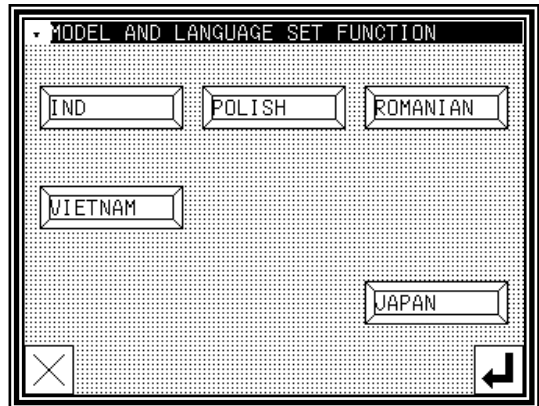

▶ If pressing , installation is started.

Please wait for a while.

▶ After installation complete,
[Machine type/Language setting] screen
on the operational panel is appeared.



(3) Model setting

▶ press .

▶ Choose Model button, then press .

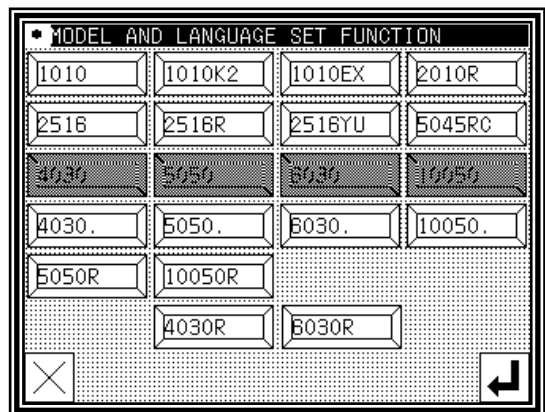

(4) Model / Language setting screen is displayed again.

▶ Press .

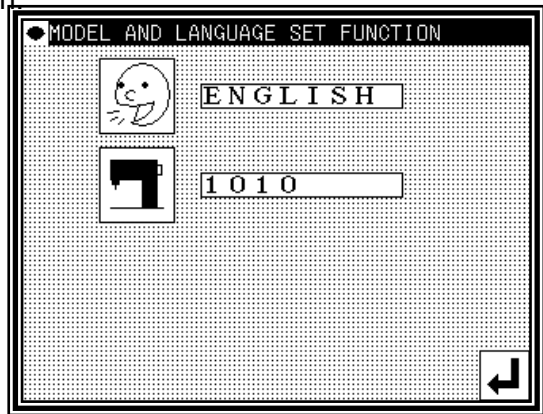

(5) Please turn the power off according to the display of the message.

(6) Setting table / Step file setting (If setting is not necessary, goto (9).)

▶ While holding down the [F] key on the front panel of the control box, turn the machine power ON. (Keep pushing [F] key until red LED on the front panel is turned on.)

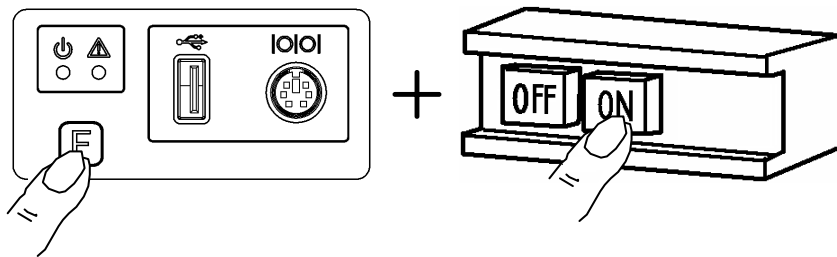



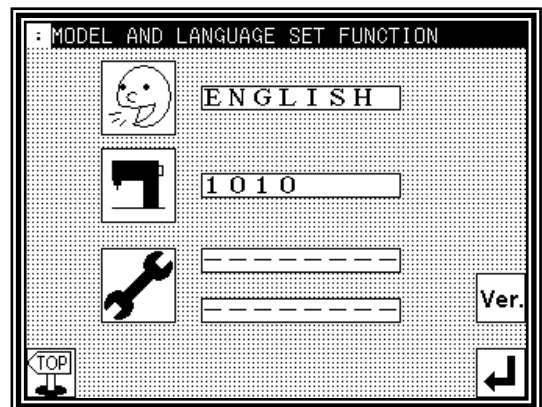

(7) Setting table / Step file setting

▶ Press .



(8) Setting table / Step file setting mode

▶ Choose one of following buttons.

-  Reads Setting table and Step file
-  Reads Setting table only
-  Reads Step file only
-  Reads System file ,Setting table and Step file

▶ Connect USB memory [*1], which above data is contained, to the connector on the front panel of the control box, then,

press .

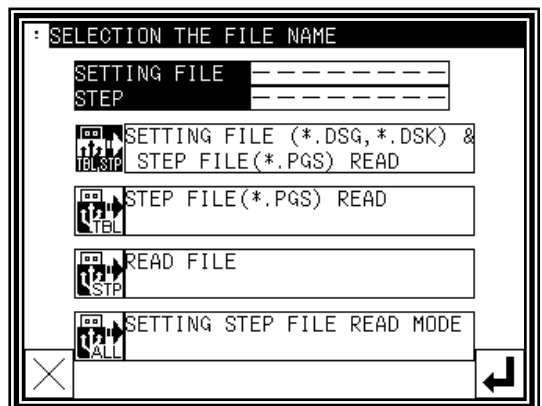

- ▶ After file name selection screen is displayed, choose target filename by using up and down arrow button, then press



[*1] Setting table and Step file must be saved in the [ USER_system] folder in the USB memory.

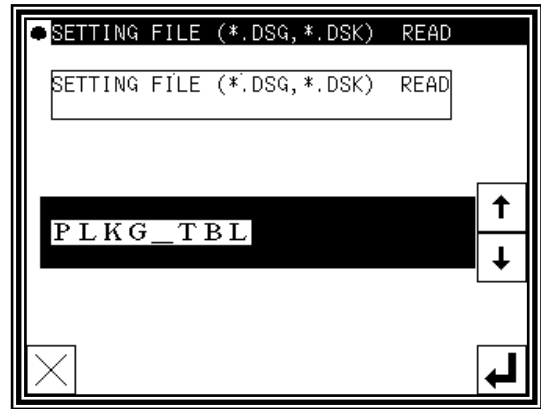

(9) Re-turning on the power supply

- ▶ Please turn the power off according to the display of the message.

- ▶ After check the LED lamp on the front panel of the control box is completely off, turn the power on.

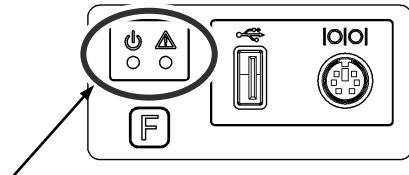

Check the LED lamp is OFF

(10) Initial condition

- ▶ At initial condition, the message like a right picture is displayed.

Press  to switch to the Standard screen, then create or read sewing pattern data. (Refer to technical manual [Operation panel].)

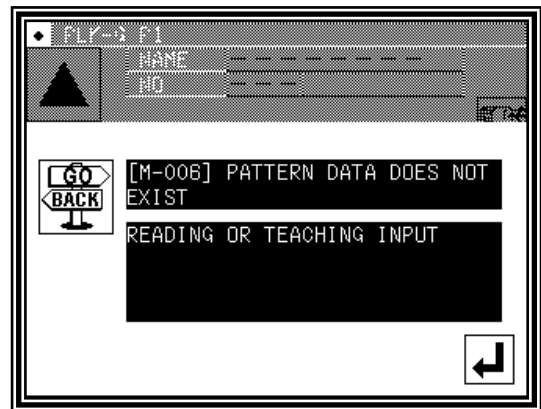

[7] Timing chart

1.Thread trimming timing chart

- Timing for thread trimming output [T] :
 - Program mode [Thread trimming/release timing] -- [LTM] T1~T5
 - Program mode [Thread trimming/release timing] -- [TRS] msec / deg
 - Program mode [Thread trimming/release timing] -- [TRE] msec / deg
- Timing for thread release output [L] :
 - Program mode [Thread trimming/release timing] -- [LLM] L1~L5
 - Program mode [Thread trimming/release timing] -- [LRS] msec / deg
 - Program mode [Thread trimming/release timing] -- [LRE] msec / deg
- Timing for wiper output [W] :
 - Program mode [Wiper] -- [W1] msec
 - Program mode [Wiper] -- [W2] msec

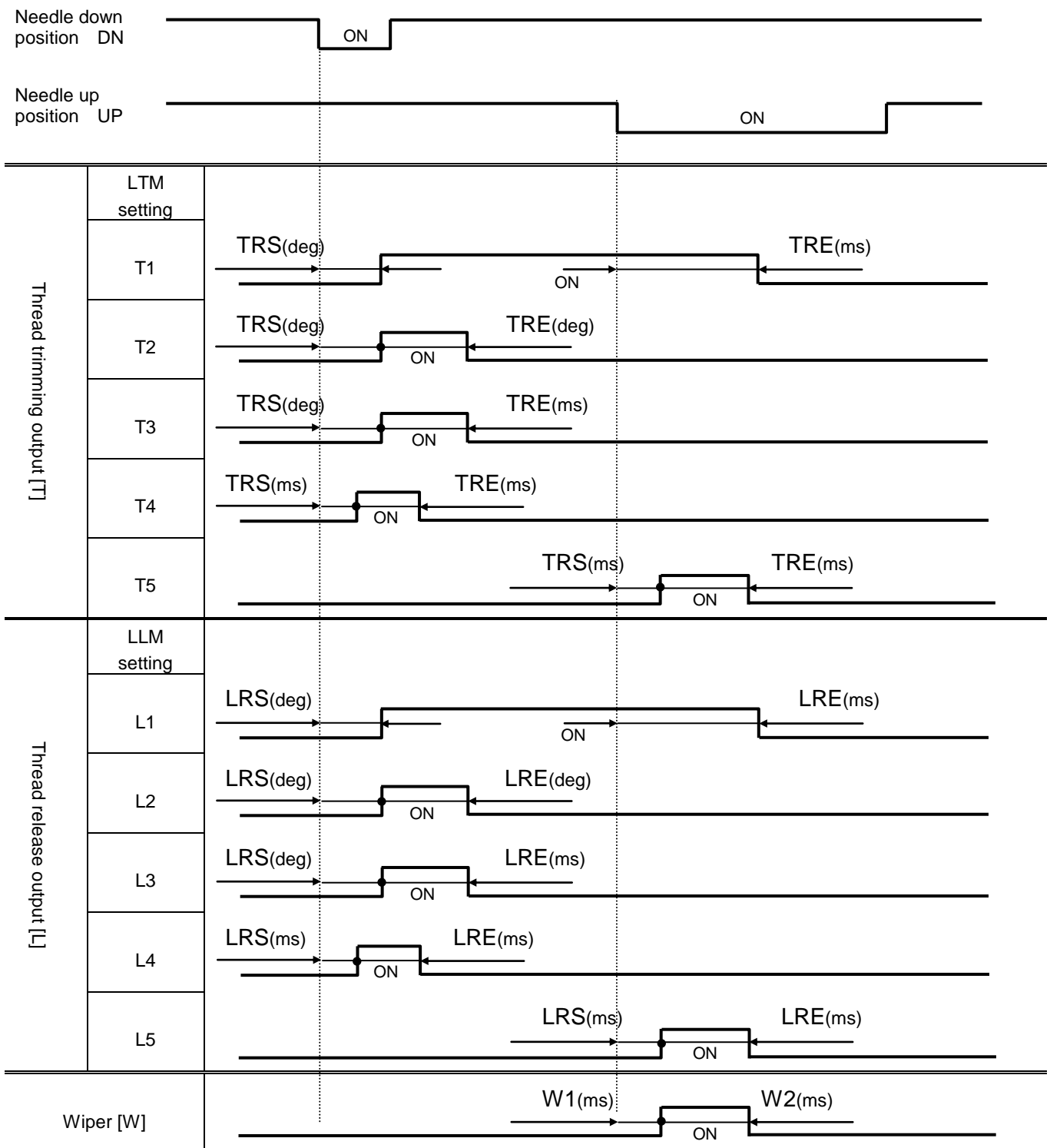

2. Timing chart for [Clamp of output ON/OFF delay setting]

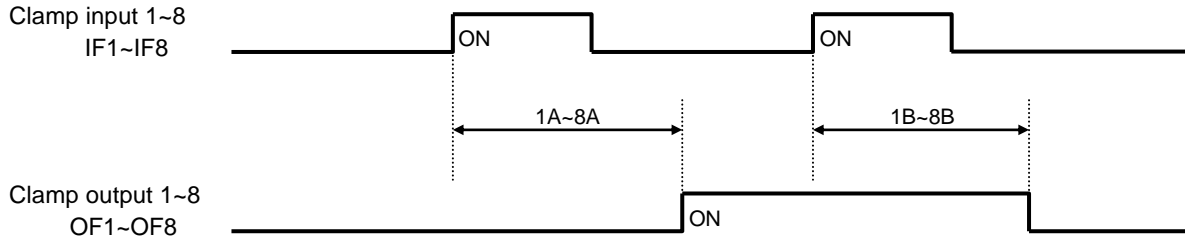

3. Timing chart for [Priority of clamp]

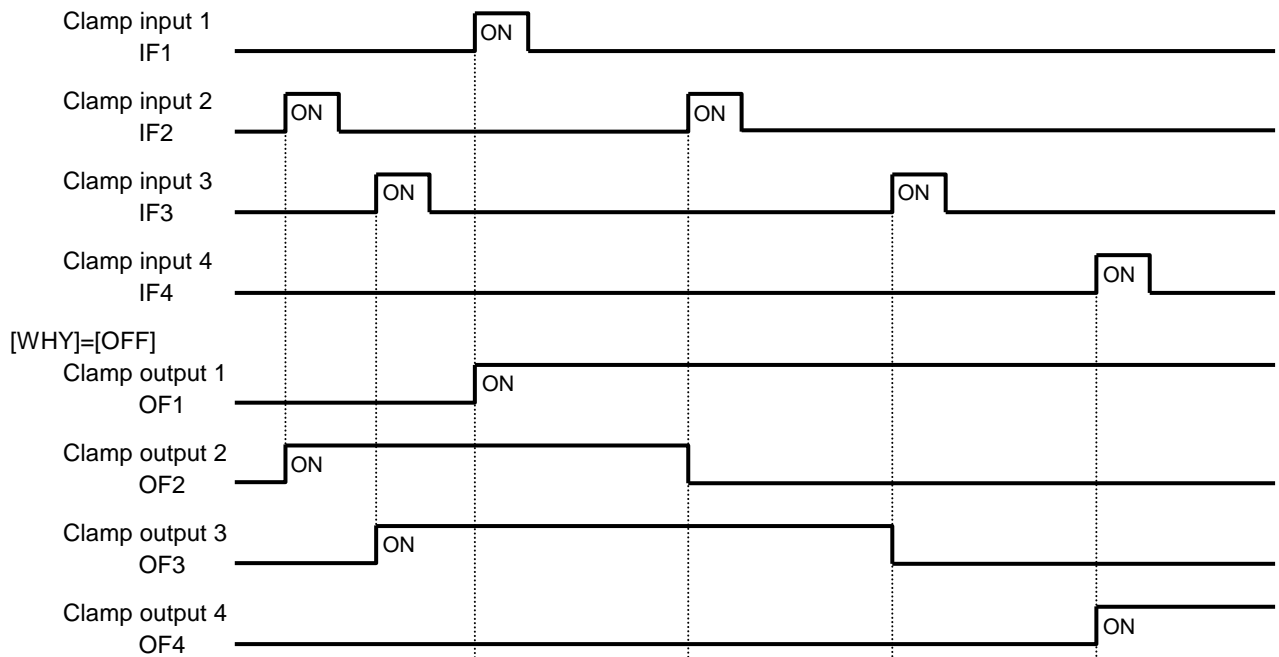

Note: [WHY]=[OFF]

*The clamp input signal [IF1],[IF2],[IF3],[IF4] is validated every time.

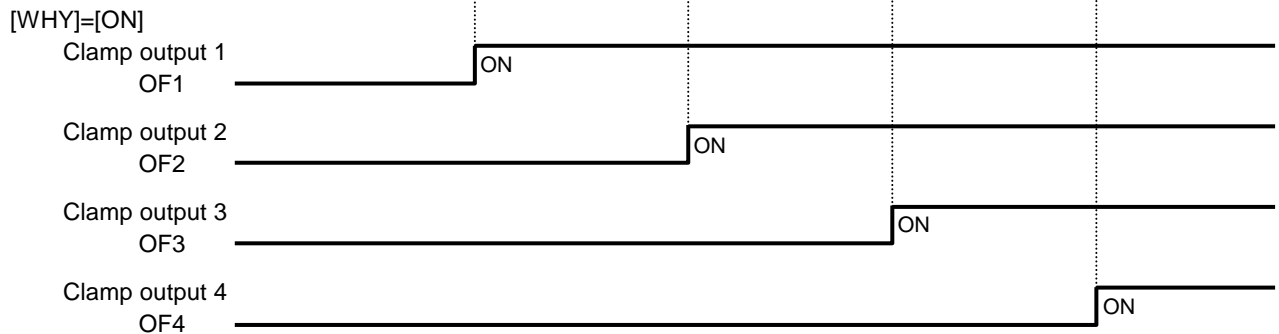

Note: [WHY]=[ON]

* The clamp input signal [IF2],[IF3],[IF4] is invalidated when clamp output 1 is not ON.

* The clamp input signal [IF2] is validated when clamp output 1 is ON.

* The clamp input signal [IF3] is validated when clamp output 2 is ON.

* The clamp input signal [IF4] is validated when clamp output 3 is ON.

4. Timing chart for

[Clamp link setting (CF)]=ON, [Valid Number of clamp setting (FN)]=4

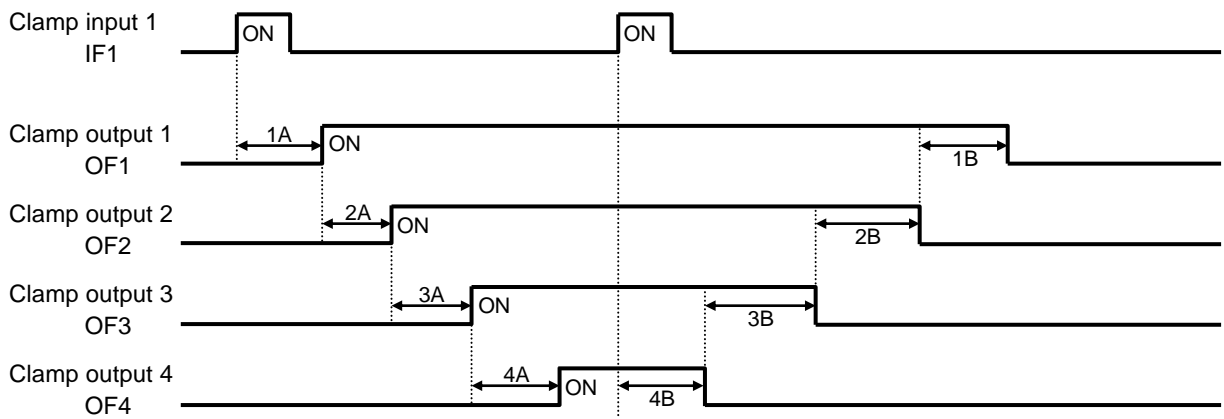

Note: Halt switch is validated.

5. Timing chart for

[Selection of pneumatic pressure two-step (AF2)]=ON

Can not use other function in "Work holder" mode.

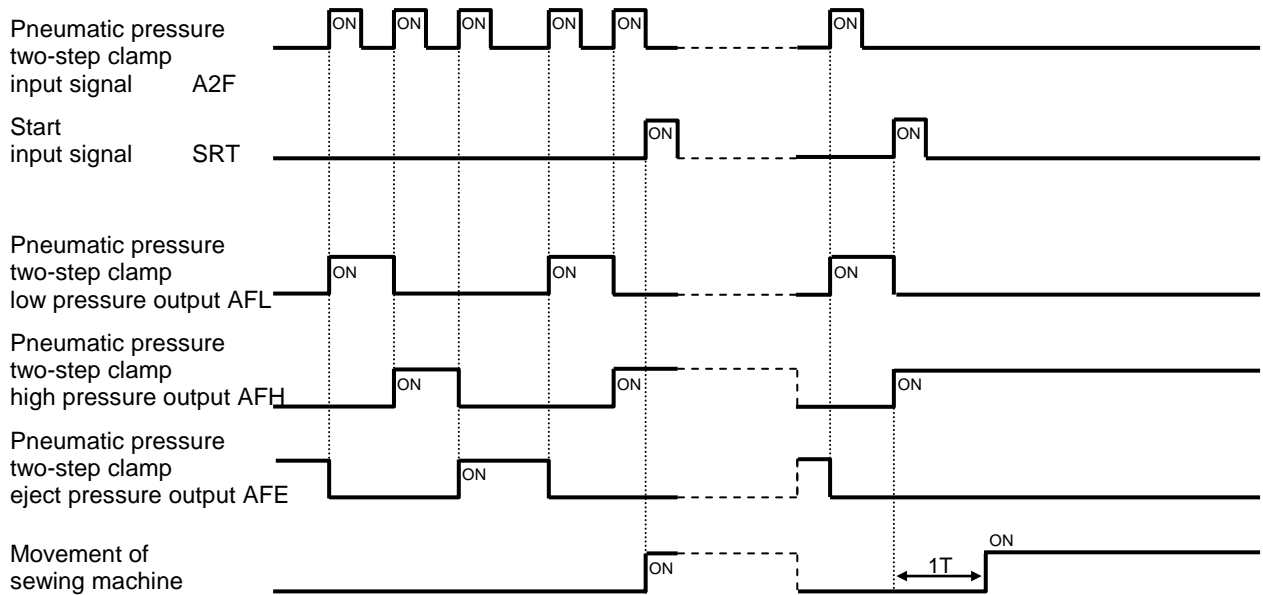

6. The divisions of clamp setting [OFB]=2

Setting of [FN],[CF],[F4BN],[F4SN] is invalidated when above setting.

[WHY]=OF,[OFB]=2,[CF1]=ON,[CF2]=OF,[F21N]=4,[F22N]=3
When not using the clamp step input.

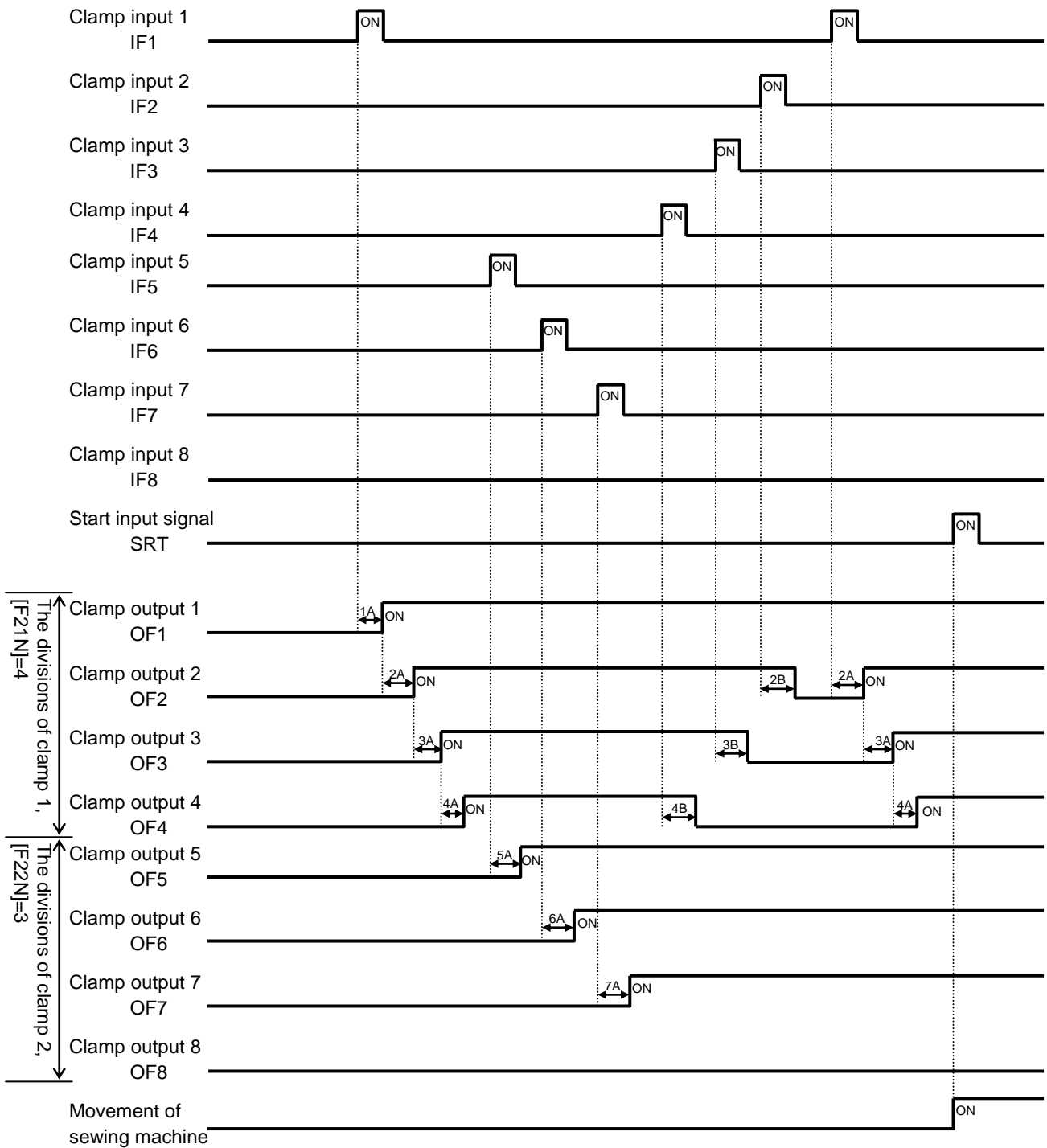

- Note 1. When the setting ([CF1]=ON), clamp input 1 is link input.
 2. When the setting ([CF2]=ON), clamp input 5 is link input.
 3. When the setting ([WHY]=ON), priority of clamp is validated in the divisions of clamp.

7. The divisions of clamp setting [OFB]=2(When using the clamp step input.)

Setting of [FN],[CF],[F4BN],[F4SN] is invalidated when above setting.

[WHY]=OF,[OFB]=2,[CF1]=ON,[CF2]=OF,[F21N]=4,[F22N]=4

When using the clamp step input.

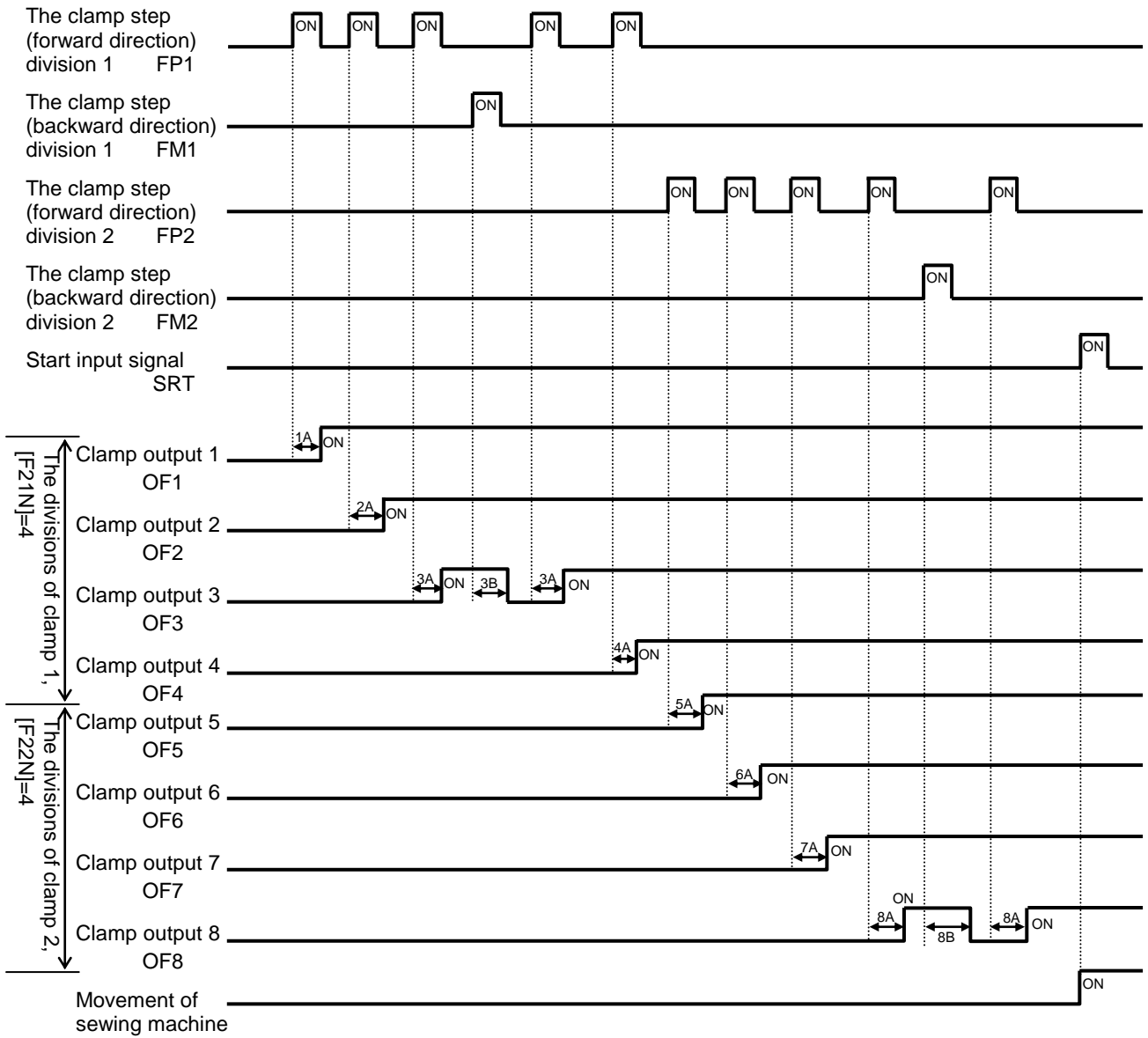

8. The divisions of clamp setting [OFB]=4

Setting of [FN],[CF],[F21N],[F22N],[CF1],[CF2] is invalidated when above setting.
 Clamp(O1,O2),(O3,O4),(O5,O6),(O7,O8) is link movement when above setting.
 Only in this case, the block division operation is possible by the setting of [F4BN].

[WHY]=OF,[OFB]=4,[F4BN]=4
 When not using the clamp step input.

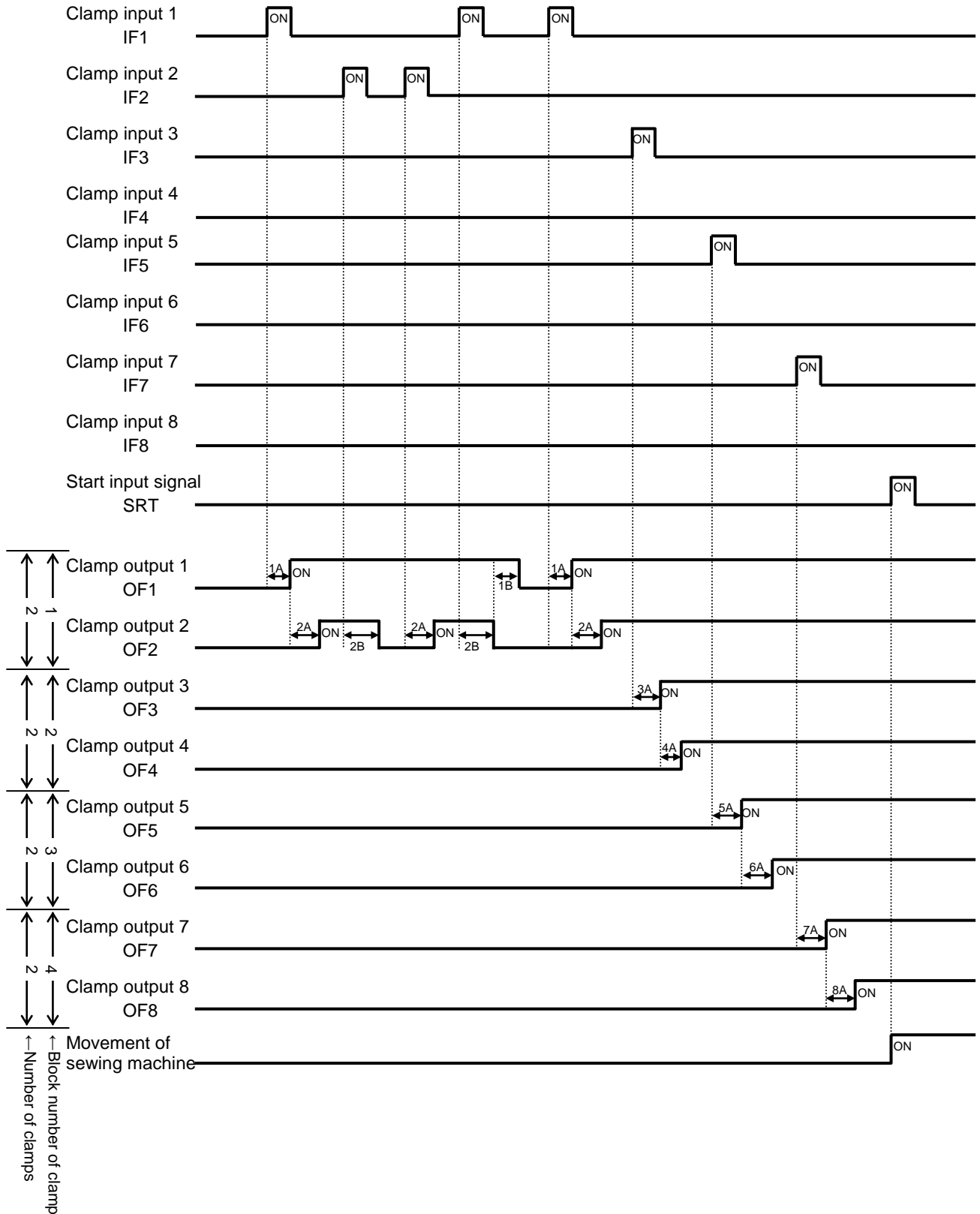

9.The divisions of clamp setting [OFB]=4

Setting of [FN],[CF],[F21N],[F22N],[CF1],[CF2] is invalidated when above setting.

Clamp(O1,O2),(O3,O4),(O5,O6),(O7,O8) is link movement when above setting.

Only in this case, the block division operation is possible by the setting of [F4BN], and block step operation is possible by the setting of [F4SN].

[WHY]=OF,[OFB]=4,[F4BN]=4,[F4SN]=4
When not using the clamp step input.

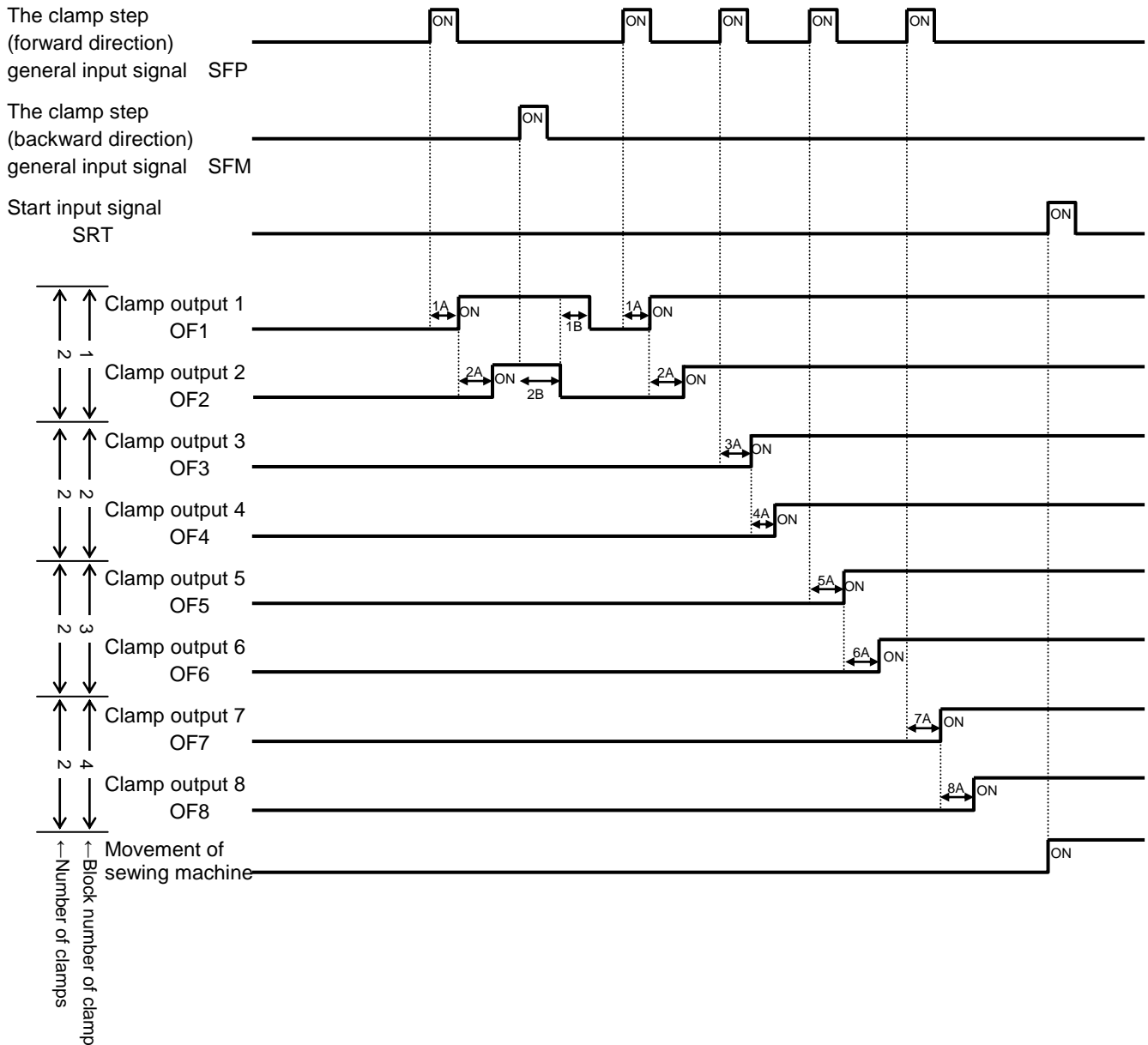

[8] Customized input/output

1. Customized input/output configuration diagram

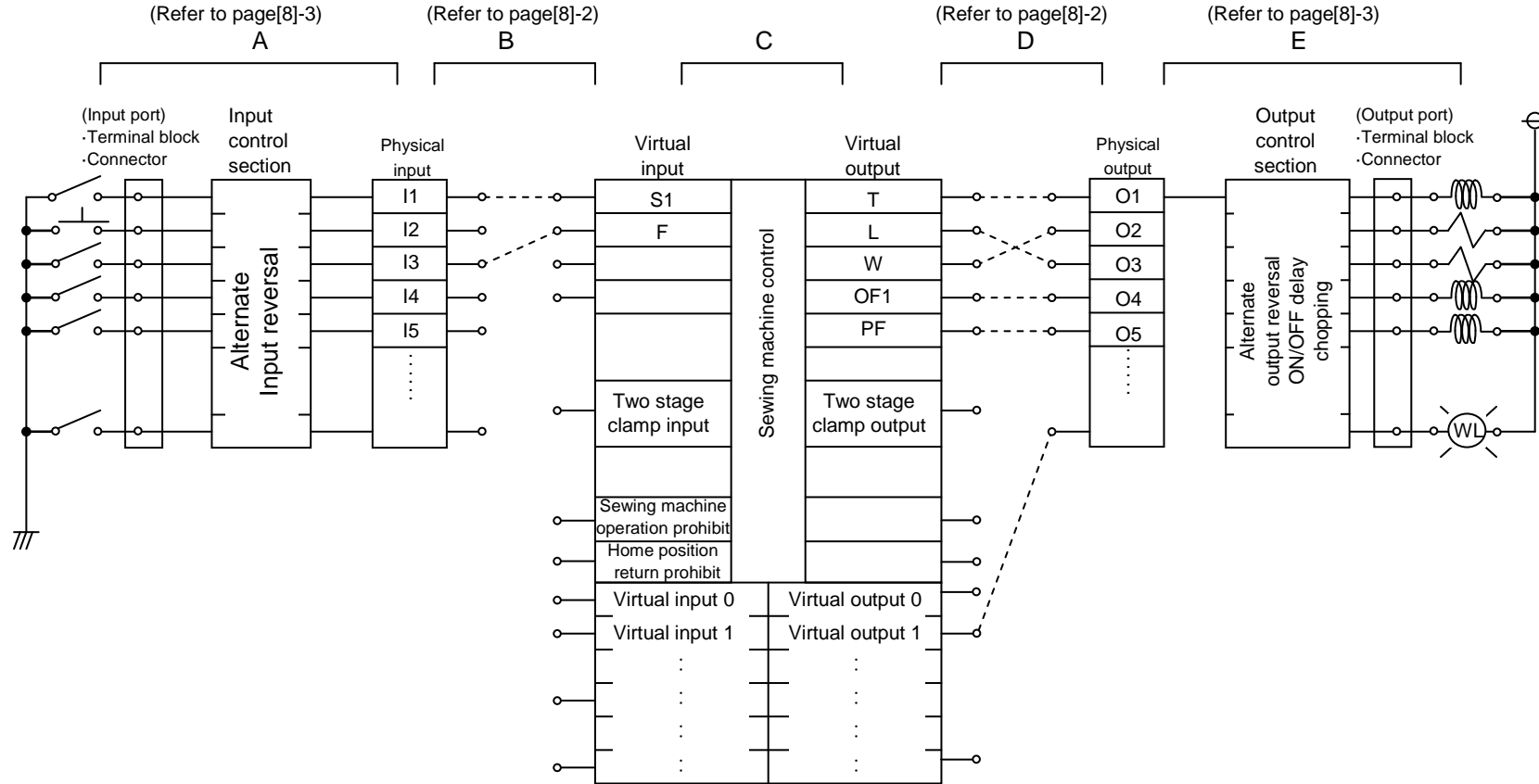

[8] - 1

2. Outline of customized input/output mode

(A to E below correspond to A to E on the previous page.)

(1) Customizing the input signal

- A. The ON/OFF signal input from the input port passes through the input control section (no operation, alternate operation, signal reversal), and is then stored in the physical input area corresponding to the input port. (Refer to page[8]-3)
- B. Each signal stored in the physical input area is connected to a desired position in the sewing machine control virtual input port. (Refer to page[8]-2)
- C. The sewing machine carries out control based on the function assigned to the virtual input area.

(2) Customizing the output signal

- D. As opposed to the customized input, the virtual output area port, assigned a specific meaning, can be connected and set to a desired position in the physical output area port. (Refer to page[8]-2)
- E. The signal for each port in the physical output area passes through the output control section (no operation, delay circuit, alternate, etc.), and is then output to the output port. (Refer to page[8]-3)

3. Customizing the virtual input/output

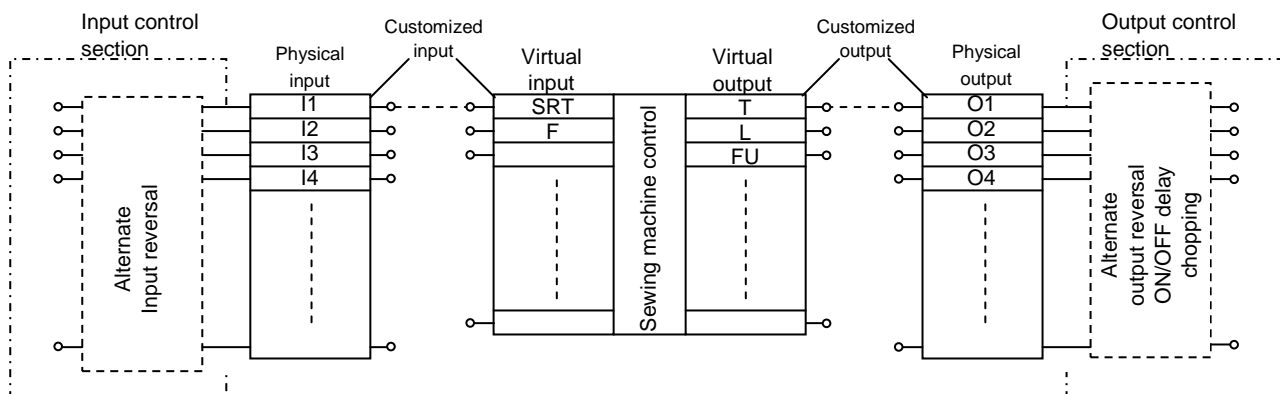

Selection and connection of physical input/output port and virtual input/output port

For example, to connect the physical input port [I1] and virtual input port [SRT] (start) and to connect the physical output port [O1] and virtual output port [T] as shown in the diagram, set as follows.

1. Using customized input, select the [I1] input functions, and set SRT.
2. Using customized output, select the [O1] input functions, and set SRT.

With the above settings, [I1] and [SRT], and [O1] and [T] will be connected.

One port from the virtual input ports can be selected for the [I*] port by changing the setting.

One port from the virtual output ports can be selected for the [O*] port by changing the setting.

4. Block diagram (input control section)

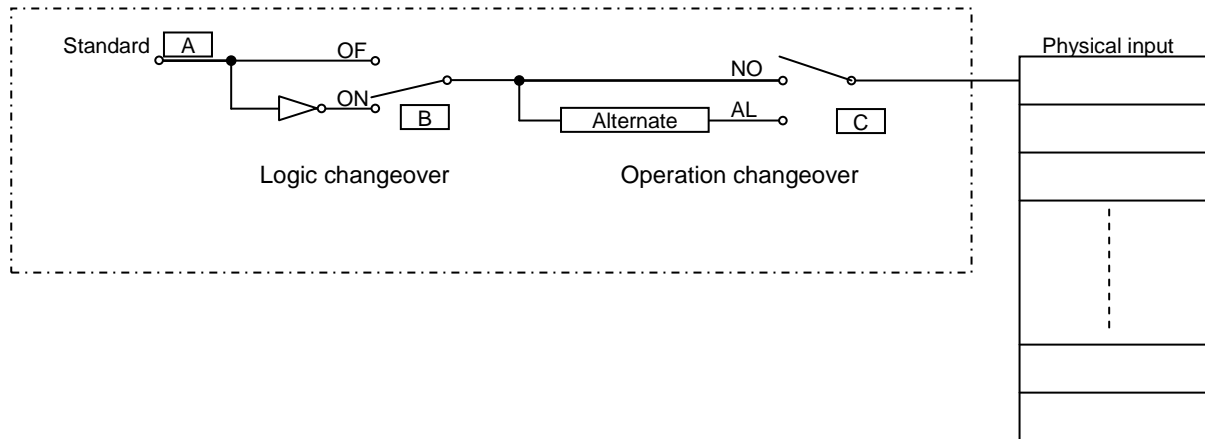

5. Explanation of operations (input control section)

The input signal passes through the A point, B point and C point of the input port, and finally is connected to the physical input

A point Inputs the signal to the input port from an external source.

B point (1) When the logic setting is set to "normal"(OF), the operation will be the same as the input signal A point.
 (2) When the logic setting is set to "reverse"(ON), the operation will be the reverse of the input signal A point.

C point (1) When the operation selection is set to "normal"(NO), the operation will be the same as the input signal B point.
 (2) When the operation selection is set to "alternate"(AL), the signal will turn ON at the first rising edge, turn OFF at the second rising edge, and will turn ON at the third rising edge. The signal waveform will repeatedly turn ON and OFF at the input rising edge.

The C point signal input and controlled in the above manner is input into the physical input port.

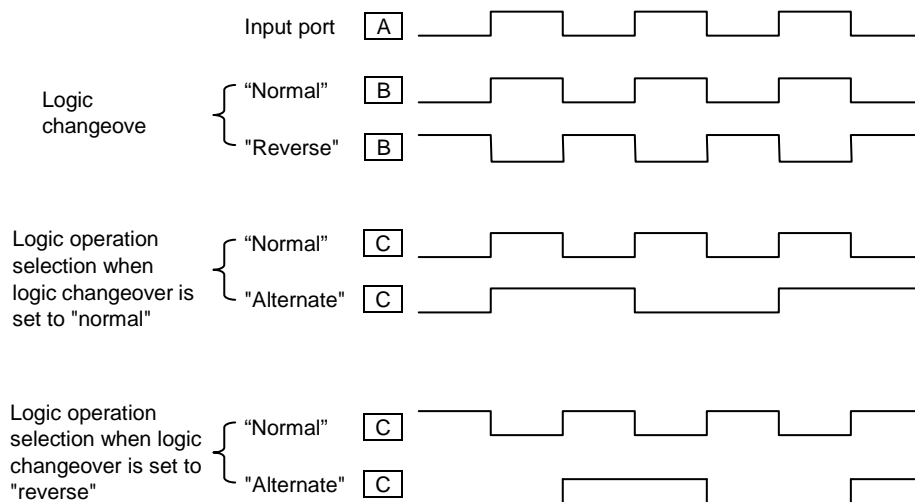

6. Block diagram (output control section)

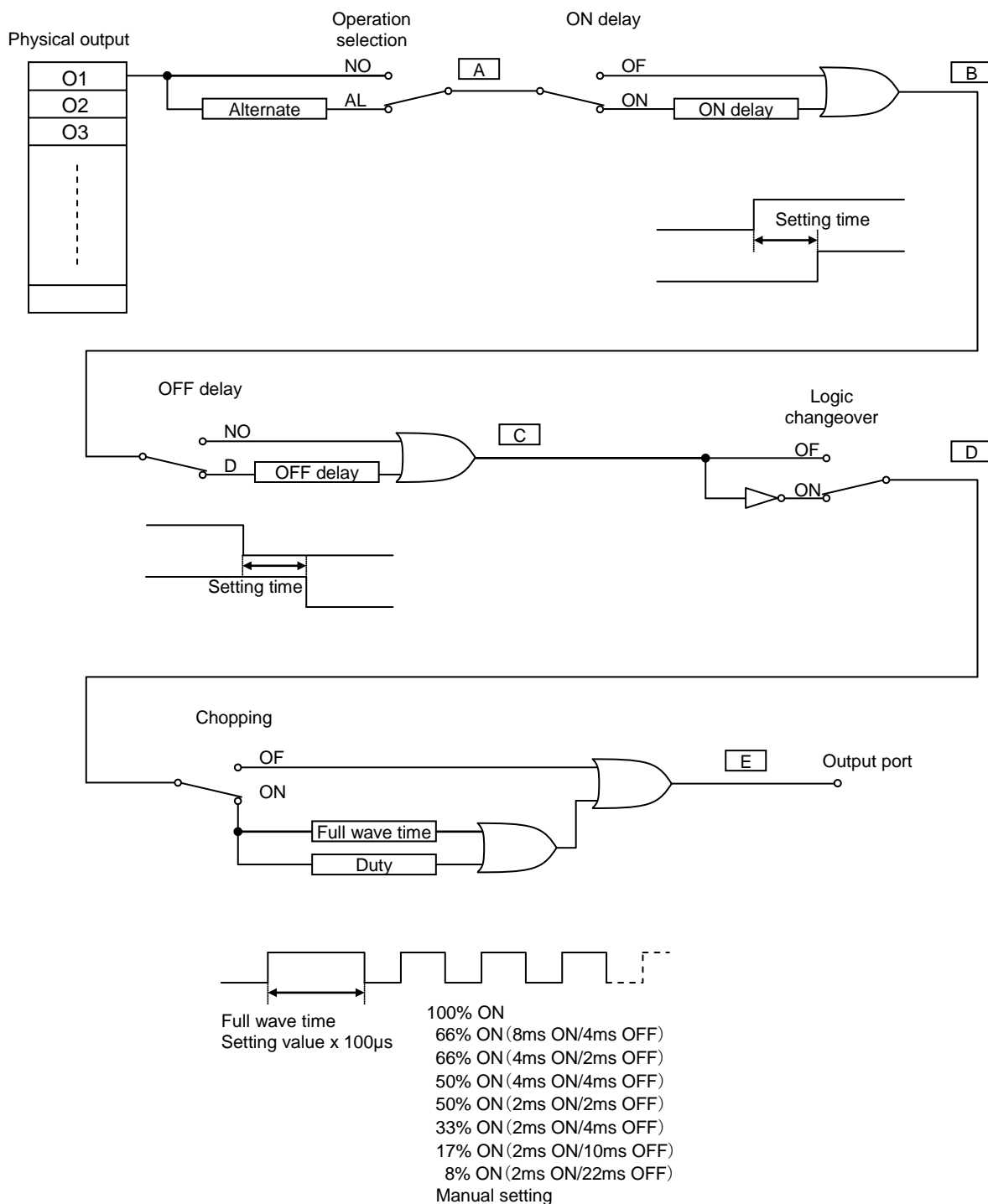

7. Explanation of operation (output control section)

The operation of the signal output from the physical output is selected and then the signal is connected to the output port F point.

A point Logic operation selection

- (1) When "normal"(NO) is selected, the input waveform is connected.
- (2) When "alternate"(AL) is selected, the signal will alternately turn ON and OFF, turning ON at the first rising edge and OFF at the next rising edge.

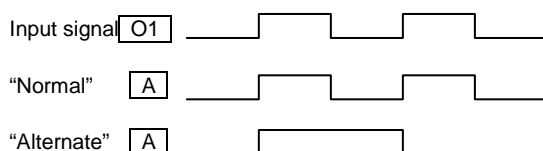

B point ON delay setting

- (1) When "invalid" is selected, the same signal as the A point will be output to the B point.
- (2) When "valid" is selected, the waveform will rise after the {set value x 100µs} time (*1) set with the A point input waveform. (ON delay)

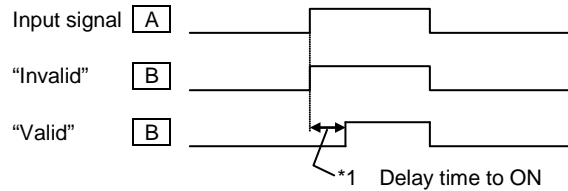

C point OFF delay setting

- (1) When "invalid" is selected, the same signal as the B point will be output to the C point.
- (2) When "valid" is selected, the ON time will be delayed by the {set value x 100µs} time (*2) set with the B point input waveform.

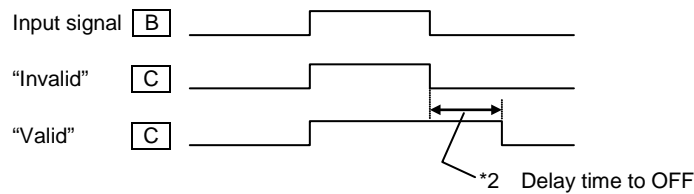

D point Logic setting

- (1) When "normal" is selected, the C point signal will be output to the D point without any changes.
- (2) When "reverse" is selected, D point signal will be reversing signal of the C point signal.

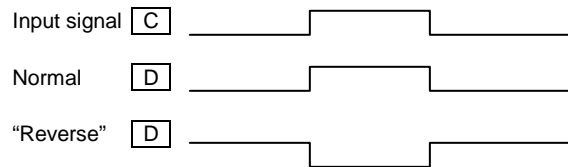

E point Chopping setting

- (1) When [100%ON] is set, there is no change, and input signal of D point is output to E point.
- (2) When other than [100%ON] is set, output of E point is on while {setting time x 100 us}. Afterwards the output becomes square wave according to duty ratio setting.

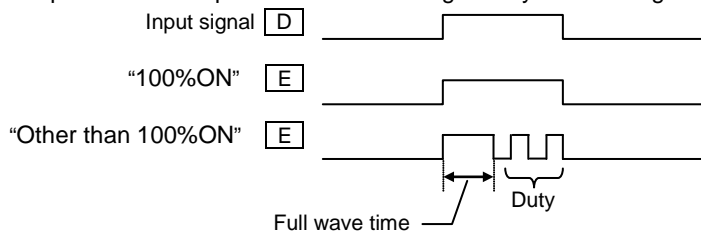

- 100% ON
- 66% ON (8ms ON/4ms OFF)
- 66% ON (4ms ON/2ms OFF)
- 50% ON (4ms ON/4ms OFF)
- 50% ON (2ms ON/2ms OFF)
- 33% ON (2ms ON/4ms OFF)
- 17% ON (2ms ON/10ms OFF)
- 8% ON (2ms ON/22ms OFF)
- Manual setting

[9] Input/Output signal

1. Input signal setting table

Code	Function	Specifications
FSP	Clamp all step ON signal	Whenever FSP input is on, clamp output [1],[2],[3],[4],[5],[6],[7],[8] turned on one by one. However, when [Program mode > Clamp output > number of effective clamp (FN)] is set to 1, FSP input is ineffective.
FSM	Clamp all step OFF signal	Whenever FSM input is on, clamp output [8],[7],[6],[5],[4],[3],[2],[1] turned off one by one. However, when [Program mode > Clamp output > number of effective clamp (FN)] is set to 1, FSM input is ineffective.
FP1	Clamp division1 step ON signal	Whenever FP1 input is on, clamp output [1],[2],[3],[4] turned on one by one.
FM1	Clamp division1 step OFF signal	Whenever FM1 input is on, clamp output [4],[3],[2],[1] turned off one by one. However [Program mode > clamp output block division number setting (OFB)] is set to no or set to 4, or [number of valid clamp setting (F21N)] is set to 1, FM1 input is ineffective.
FP2	Clamp division2 step ON signal	Whenever FP2 input is on, clamp output [5],[6],[7],[8] turned on one by one.
FM2	Clamp division2 step OFF signal	Whenever FM2 input is on, clamp output [8],[7],[6],[5] turned off one by one. However [Program mode > clamp output block division number setting (OFB)] is set to no or set to 4, or [number of valid clamp setting (F22N)] is set to 1, FM2 input is ineffective.
IFR	All clamp output clear signal	If IFR signal is on, all clamp outputs are turned off.
A2F	Pneumatic two-step clamp switch input signal	Whenever A2F input is on, following operation (1), (2), (3) is repeated. This signal is effective when [Program mode > Setting for Pneumatic two-step clamp(AF2)] is on. <div style="border: 1px solid black; padding: 5px; margin: 10px auto; width: fit-content;"> <p>(1)When A2F input is on first time, AFL output is turned on. (2)When A2F input is on second time, AFH output is turned on. (3) When A2F input is on third time, AFE output is turned on.</p> </div>
IF1~IF8	Clamp input signal 1 ~ 8	When IF1 input is on, OF1 output is turned on. When IF1 input is on again, OF1 output is turned off. (same from IF2 to IF8)
F1C~F8C	Clamp output prohibition signal 1 ~ 8	When F1C input is on, OF1 output is prohibited. (same from F2C to F8C)
OFC	All clamp output cancel signal	When OFC input is on, OF1 to OF8 outputs are prohibited.
WC	Wiper output cancel signal	When WC input is on, W output is prohibited.
TC	Trimmer output cancel signal	When TC input is on, Thread trimmer sequence output T, L and W is prohibited.
S6	Thread trimming protection signal	When S6 input is on while machine is driving, the machine is stopped and when S6 input is off, the machine start driving again. When S6 input is on while thread trimming operation, machine is stopped after trimming.
HPC	Home positioning prohibition signal	When HPC is ON, home returning operation by the home positioning key or HP signal is prohibited.
TH2	Upper thread sensor 2 input signal	When setting of [Program mode > Needle thread breaking sensor 2 ON/OFF] is on, the signal can be used for thread breakage detection input (channel 2).
THS	Upper thread sensor input signal	When setting of [Program mode > Needle thread breaking sensor ON/OFF] is on, the signal can be used for thread breakage detection input.
ARS	Less pressure detection signal	When ARS input is on, all operation is interrupted, and error [E-025] is displayed. (Returns by power supply re-turning on)
IO0~IOF	General purpose input 0 ~ F	When IO0 input is on, OT0 output is turned on at the same time. (same from IO1 to IOF)
NO	No operation signal	Anything does not operate, if NO input is turned on.
SRT	Start signal	When SRT input is on, sewing operation is started. However, when clamp output is turned off, this signal is invalid.
HP	Home position returning signal	When HP input is on, home position returning operation is executed. However, please note there is a timing that becomes invalid, for example while machine is running.
PF	Presser foot signal	When PF input is on, The presser foot will return to home position. When PF input is on again, presser foot goes to down position.
JGP	JOG plus signal	When JGP input is on, XY table is moved in positive direction according to the pattern.
JGM	JOG minus signal	When JGP input is on, XY table is moved in negative direction according to the pattern.
STP	Halt signal	When STP input is on, machine is stopped.

< sequel to INPUT SIGNAL >

Code	Function	Specifications
BC	Fixed angel (rotation/reverse rotation) signal	To confirm the needle thrust position, the needle is stopped just before the sewing material. Whenever BC input is ON, operation of [rotation] → [reverse rotation] → [rotation] is repeated. When the start switch is on afterwards, following sewing operation is started. However, if the following data is non stitch feed, the message [M-020] is appeared, in this case please move the needle to up position and re-turning on the start switch. Setting value of fixed angle can be set in the [Function mode > Needle down angle setting].
CCL	Counter clear signal	When CCL input is on, UP/DOWN counter is cleared.
SRC	Start cancel signal	When SRC input is on, sewing operation with Stringhalt is prohibited.
CCU	Up counter clear signal	When CCU input is on, UP counter is cleared.
CCD	Down counter clear signal	When CCD input is on, DOWN counter is cleared.
UAD	Up counter addition signal	When UAD input is on, 1 is added to UP counter
UDC	Up counter subtraction signal	When UDC input is on, 1 is subtracted from UP counter
DAD	Down counter addition signal	When DAD input is on, 1 is added to DOWN counter
DDC	Down counter subtraction signal	When DDC input is on, 1 is subtracted from DOWN counter
KNK	Signal that invalidates MENU key	When KNK is on, "MENU" key becomes invalid.
RNK	Signal that invalidates "pattern read" key	When RNK is on, "pattern read" key becomes invalid.
WNK	Signal that invalidates "pattern write" key	When WNK is on, "pattern write" key becomes invalid.
INK	Signal that invalidates "teaching input" key	When INK is on, "teaching input" key becomes invalid.
MNK	Signal that invalidates "teaching modification" key	When MNK is on, "teaching modification" key becomes invalid.
CNK	Signal that invalidates "teaching conversion" key	When CNK is on, "teaching conversion" key becomes invalid.
PNK	Signal that invalidates "program mode" key	When PNK is on, "program mode" key becomes invalid.
NNK	Signal that invalidates "IN/OUT setting" key	When NNK is on, "IN/OUT setting" key becomes invalid.
FNK	Signal that invalidates "function mode" key	When FNK is on, "function mode" key becomes invalid.
SNK	Signal that invalidates "speed" key	When SNK is on, "speed" key becomes invalid.
P01	Pattern number switch signal +1	When P01 is on, pattern data number is switch to 801 (800+1).
P02	Pattern number switch signal +2	When P02 is on, pattern data number is switch to 802 (800+2).
P04	Pattern number switch signal +4	When P04 is on, pattern data number is switch to 804 (800+4).
P08	Pattern number switch signal +8	When P08 is on, pattern data number is switch to 808 (800+8).
P16	Pattern number switch signal +16	When P16 is on, pattern data number is switch to 816 (800+16).
P32	Pattern number switch signal +32	When P32 is on, pattern data number is switch to 832 (800+32). <div style="border: 1px solid black; padding: 5px; margin: 5px 0;"> <p style="text-align: center;">< When you want to change to other patterned numbers ></p> <p style="text-align: center;">ex.1) pattern number to 803 turns on P01 input and P02 input $P01 (+1) + P02 (+2) + 800 = 803$</p> <p style="text-align: center;">ex.1) pattern number to 811 turns on P01, P02 and P08 input $P01 (+1) + P02 (+2) + P08 (+8) + 800 = 811$</p> </div> <p>*Pattern number can be changed within the range from 800 to 863. *P01,P02,P04,P08,P16,P32 is effective when [Pattern select function by external signal(APC)] has been set to ON.</p>
IFA	DO NOT USE	
HES	Machine head tilting detection signal	When HES input is on, message [M-038] is displayed.
I_g	DO NOT USE	
I_A	DO NOT USE	

< sequel to INPUT SIGNAL >

Code	Function	Specifications
SP0~SP9	Speed dial signal	Speed dial value is switched to 0~9.
SPU	Speed up signal	Speed dial value is increased +1.
SPD	Speed down signal	Speed dial value is decreased -1.
CK1	Cassette jig sensor 1 signal	When CK1 and CK2 inputs is on, OF1 output turn on.
CK2	Cassette jig sensor 2 signal	*CK1 and CK2 is effective when [Cassette jig function ON/OFF(CHK)] and [Cassette jig sensor ON/OFF(CSN)] has been sets to ON.

2. Output signal setting table

Code	Function	Specifications
OT0~OTF	General purpose output 0 ~ F	When IO0 is on, OT0 output at the same time (same from OT1 to OTF)
FN1~FNH	Function code output 1 ~ H	When FUN1 code is read while sewing operation, FN1 output is reversed. (same from FN2 to FNH)
OF1~OF8	Clamp output 1 ~ 8	When IF1 is on, OF1 output is reversed (same OF2 to OF8)
NO	[NO]output	Nothing is done
T	Trimmer output	Trimming operation is done
L	Thread tension release output	Thread tension release operation is done
W	Wiper output	Wiper operation is done
PF	Presser foot output	Presser foot operation is done
AFL	Pneumatic two-step switch clamp low pressure output	When A2F input is on first time, AFL output is turned on. Setting is effective when [Program mode > Clamp > Pneumatic two-step switch clamp ON/OFF (AF2)] is on.
AFH	Pneumatic two-step switch clamp high pressure output	When A2F input is on second time, AFH output is turned on. Setting is effective when [Program mode > Clamp > Pneumatic two-step switch clamp ON/OFF (AF2)] is on.
AFE	Pneumatic two-step switch clamp excess pressure release output	When A2F input is on third time, AFE output is turned on. Setting is effective when [Program mode > Clamp > Pneumatic two-step switch clamp ON/OFF (AF2)] is on.
DHP	Home position output	When XY table is sopped on the home position, DHP output is turned on.
D2H	Second home position output	When XY table is sopped on the second home position, DHP output is turned on.
RED	Preparation ready output	When the machine is ready state (when clamp output is on), RED output is turned on. When machine is start sewing, RED is turned off.
DSW	Sewing in progress output	When the machine is sewing, DSW output is turned on. When machine is stopping on the home position, DSW output is turned off.
SP	Sewing machine rotation start output	After non stitch feed, when the sewing machine start to rotate, SP output is turned on. When home positioning is executed, SP output is turned off.
TSE	Trimming start output	When trimming sequence (down position) is started, TSE output is turned on. When trimming sequence is finished (when all the outputs of T, L and W are turned off), TSE output is turned off.
END	Sewing completion output	When a sewing pattern operation is finished, END output is turned on. When the next sewing is started, END output is turned off.
DCS	Halt code output	When the halt code data (USTP, DSTP) is read while sewing, DCS output is turned on. When the machine restarts DCS output is turned off.
DST	Halt in progress output	When the machine is on halt state, DST output is turned on. When the machine restarts DST output is turned off. However, it is not output while stopping by the USTP code or the DSTP code.
HPO	Home returning in progress output	While the operation of home returning by the home positioning key or HP signal, HPO output is turned on.
ERR	Error output	When the error or message is displayed on the operation panel, ERR output is turned on.
CUE	Count up completion output	When the current value of up counter is reached at counter set value, CUE output signal is turned on. When the current value is cleared, CUE output is turned off.
CDE	Countdown completion output	When the current value of down counter is reached at 0, CDE output signal is turned on. When the current value is initialized, CDE output is turned off.
DTS	Halt in progress output after upper thread sensor detection	When the machine is on halt state with thread breakage, DTS output is turned on. When the machine restarts, DTS output is turned off.
--1	DO NOT USE	
DRT	Sewing machine rotation in progress output	While the machine is rotating, DRT output is turned on. (includes rotation in winding mode)
DN	Down position output	When the needle is down position, DN output is turned on.
CB	Buzzer output	While the buzzer in the operation panel is on, CB output is turned on. (including count up/countdown message display)
UP	Up position output	When the needle is up position, UP output is turned on.
PWR	Power on output	While power supply is on, PWR output signal is turned on.
PUS	Presser hoot home position output	While presser foot is on the home position, PUS output is turned on.
MSG	Message display output	When the message is displayed on the operation panel, ERR output is turned on.
OP1	Option output 1	General purpose output signal 1
OP2	Option output 2	General purpose output signal 2
SSW	Halt signal being on output	SSW is turned on during power supply is on. However, input signal STP turns on SSW is turned on with blinking.
MOV	Sending table's moving output signal	Turn on during XY table is moving. (It does not turn on when automatic sewing operation)

[10] What happened? Could it be an error?

When an error occurs, the error code and corresponding message appear on the operation panel. Take a corrective action in accordance with the message. This section describes the errors and others that do not appear on the operation panel.

[Case1]

Nothing appears on the operation panel when you turn the power switch ON.
(Both the front panel green (power) and red (warning) LEDs are off.)

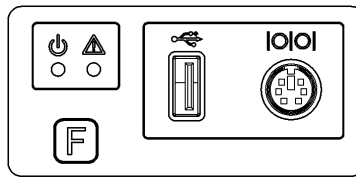

[Checking Items and Corrective Actions]

Is the power switch definitely turned ON?

- Check the power supply connection and turn ON the power switch again.

Is the power supply connector fully connected?

- Check the power supply connector connection, contact state and others, and then turn ON the power switch again.
Refer to “(12) Unit Wiring Diagram.”

Is there a blown fuse in the control box?

- Replace the blown fuse with a fuse of identical capacity.
Refer to page. [2]-2

Is a harness inside the control box disconnected?

- Check the connections of the harnesses inside the control box, and turn ON the power switch again.
Refer to “(15) Wiring Diagram Inside Control Box”

[Case2]

Nothing appears on the operation panel when you turn the power switch ON. (The front panel red (warning) LED is on or flickering.)

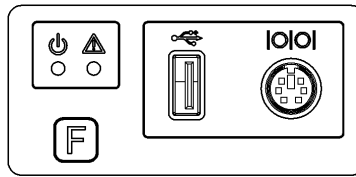

		Red (warning) LED flickering pattern
Pattern1	Blink once	☀ - - - ☀ - - - ☀ - - - ☀ - - - ☀ - - -
Pattern2	Blink twice	☀ - ☀ - - - ☀ - ☀ - - - ☀ - ☀ - - -
Pattern3	Blink 3 times	☀ - ☀ - ☀ - - - ☀ - ☀ - ☀ - - -
Pattern4	Blink 4 times	☀ - ☀ - ☀ - ☀ - - - ☀ - ☀ - ☀ - ☀ - - -

☀ : ON - : OFF

[Checking Items and Corrective Actions]

Is the front panel red (warning) LED on?

- A system error occurred. Reinstall the system.
Refer to “[Action Method 1] Reinstalling the System” later in this section.
- If you take a corrective action but no improvement is made, consult with your local representative.

Is the front panel red (warning) LED showing flickering pattern 1?

(Refer to the above table.)

- A communication error occurred. Please turn on the power again after check connection of the operation panel cable.
- If you take a corrective action but no improvement is made, consult with your local representative.

Is the front panel red (warning) LED showing flickering pattern 2?

(Refer to the above table.)

Open the control panel lid. Is fuse 2.5A on the PLK-G3-CPU board blown?

- Replace the blown fuse with a fuse of identical capacity.
Refer to page. [2]-2

Is the front panel red (warning) LED showing flickering pattern 3?

(Refer to the above table.)

- The backlight of the operation panel may be burnt out. Consult with your local representative.

Is the front panel red (warning) LED showing flickering pattern 4?

(Refer to the above table.)

- There is a problem in the control box. Consult with your local representative.

[Case3]

Though you turn the power switch ON and a screen appears on the operation panel, the screen display is incorrect.

[Checking Items and Corrective Actions]

Is the problem solved when you switch the screen or turn the power switch OFF and then ON again?

- Reinstall the system.
Refer to “[Action Method 1] Reinstalling the System” later in this section.
- If you take a corrective action but no improvement is made, consult with your local representative.

[Case4]

**I press the foot pedal, but the machine does not run.
The message “MACHINE HEAD TILT WAS DETECTED” appears.**

[Checking Items and Corrective Actions]

Is the machine tilted?

- Return the machine back to its proper state and try again.
- Check if the tilting sensor switch is damaged or disconnected.

Is the signal HES among the input signals changed?

- Check input customization.

[Case5]

No screen appears on the operation panel when you turn the power switch ON. (The front panel red (warning) LED is off.)

[Checking Items and Corrective Actions]

The operation panel may be defective.

- Consult with your local representative.

[Action Method 1] Reinstalling the System

The sewing machine is normally shipped with the system installed. However, if a reinstallation is required for some reasons and others, reinstall the system using a USB memory, and follow the method below.

(1) Save the system data in a USB memory.

(Refer to page[10]-8 [System data save to USB memory])

- ▶ Copy the [ PLKG_system] folder where the installed system datas are included, into the root directory of USB memory.

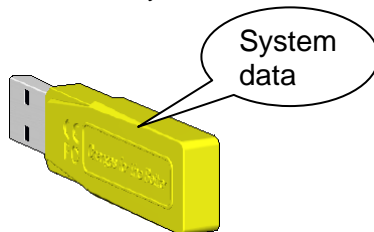

(2) Turn the machine power OFF and insert the USB memory.

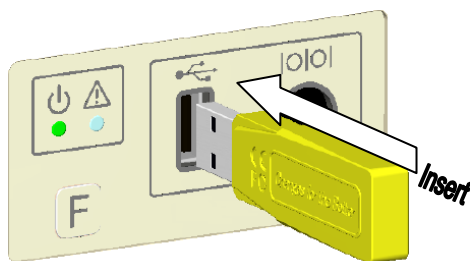

(3) While holding down the [F] key on the front panel of the control box, turn the machine power ON. (Keep pushing [F] key until red LED on the front panel is turned on.)

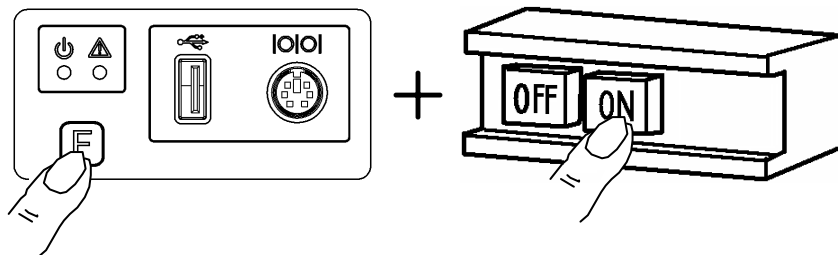

(4) Installation is started. Please wait for a while.

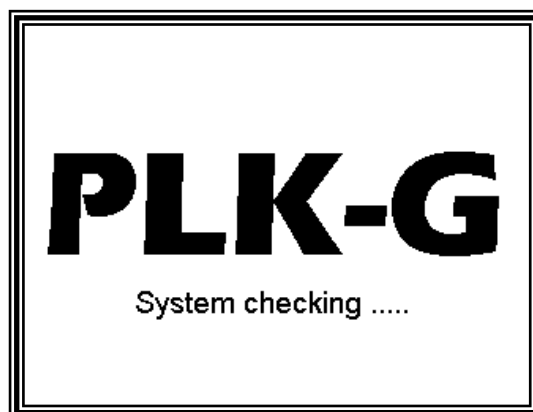

(5) After installation complete, [Machine type/Language setting] screen on the operationpanel is appeared.

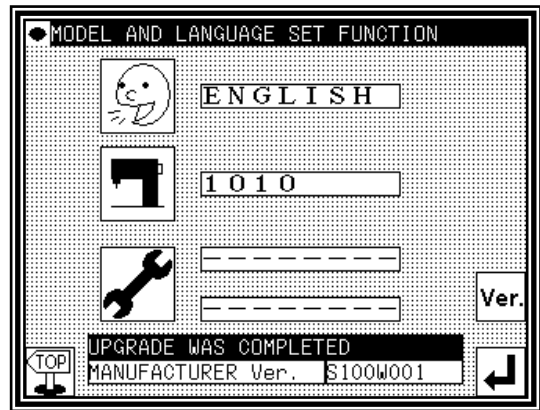

(6) Pull out USBmemory.

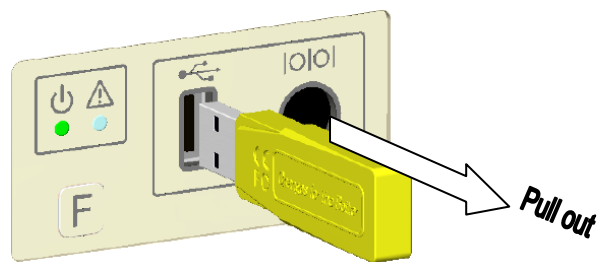

(7) Language setting

▶ press

▶ Choose Language button, then press

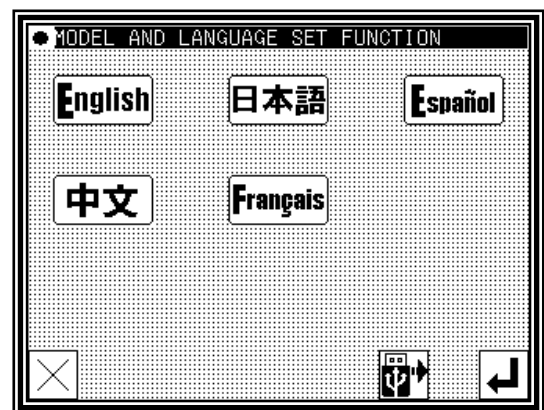

▪ How to select the multi-language

▶ Insert the USB memory that copied system data, then press

(Refer to page[6]-1 [1. Model/Language Settings])

(8) Model setting

▶ press

▶ Choose Model button, then press

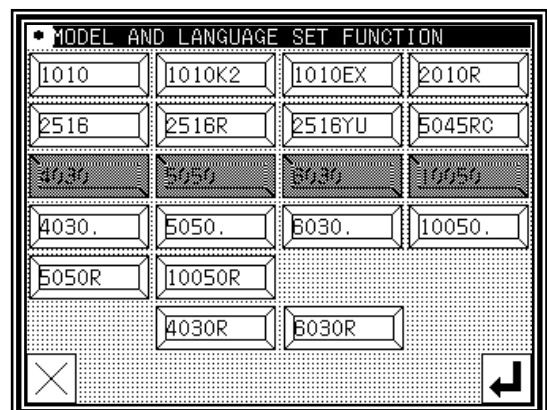

(9) Setting table / Step file setting

▶ For Setting table/ step file setting, press



If setting is not necessary, goto (10).

▶ Choose one of following buttons.



Reads Setting table and Step file

Reads Setting table only

Reads Step file only

Reads System file ,Setting table and Step file

▶ Connect USB memory [*1], which above data is contained, to the connector on the front panel of the control box, then, press



▶ After file name selection screen is displayed, choose target filename by using up and down arrow button,

then press



. Goto (12)

[*1] Setting table and Step file must be saved in the [USER_system] folder in the USB memory.

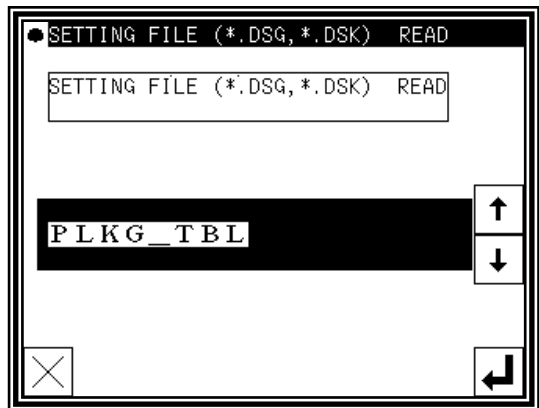
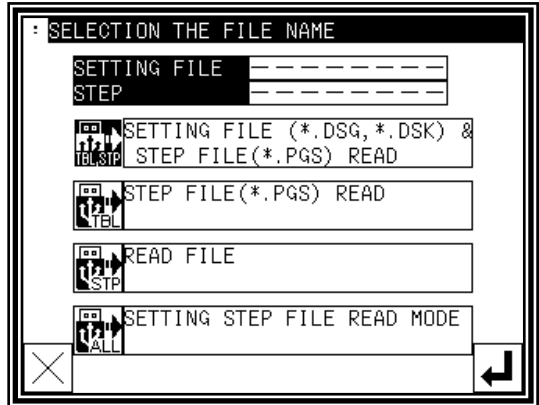
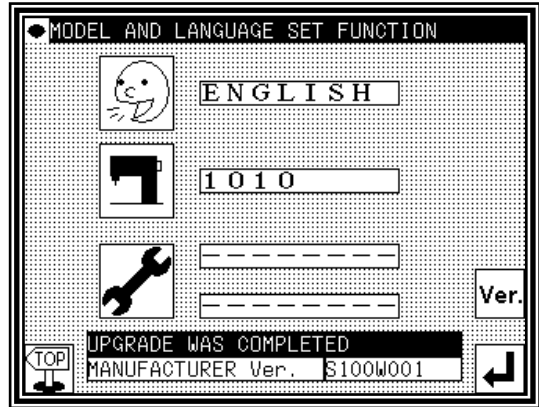

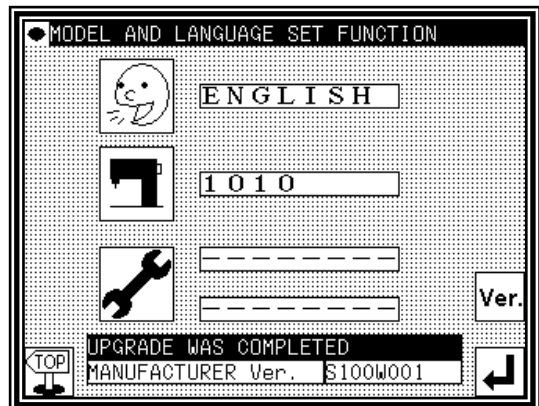

(10) Model / Language setting screen is displayed again.

▶ press



(11) Initialize of set value

► To initialize set value, press .
(Setting will be returned to the factory setting)

To exit without setting, press .

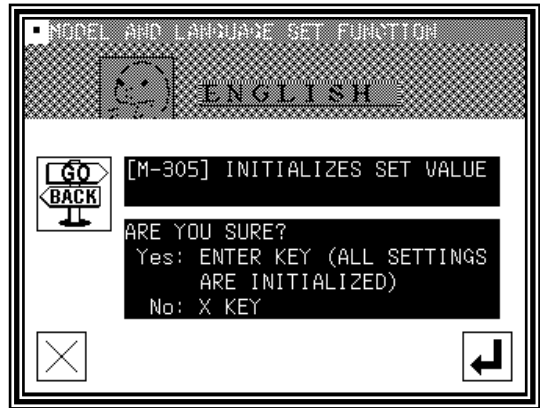

(12) Re-turning on the power supply

► Turn the power off.

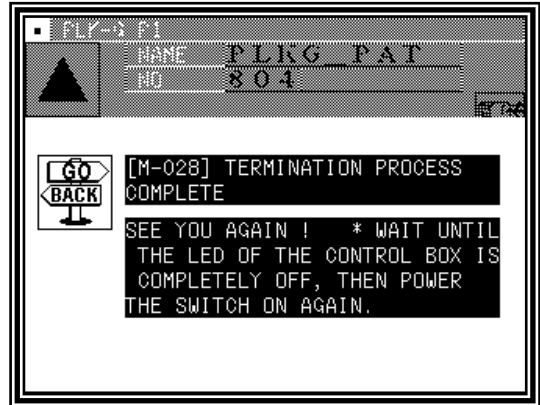

► After check the LED lamp on the front panel of the control box is completely off, turn the power on.

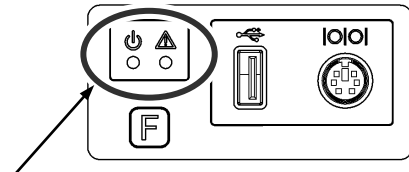



Check the LED lamp is OFF

► Reinstallation is complete.

[System data save to USB memory (using copy tool)]

[Outline] Coping system data of the CD-ROM to the USB memory by using copy tool.

[Note] If “ PLKG_system ”, “ USER_system”is already exist in the USB memory, they are over-written.
(Please move necessary data to other folder or memory before using copy tool.)

- (1) Inset the PLK-G Document CD-ROM to your PC.
Insert USB memory to the USB connector on your PC.
Check the CD-ROM drive and USB memory drive.
(ex. CD-ROM drive= “D:” , USB memory drive = “E:”)
- (2) Open the CD-ROM root directory by using exploler etc.
Double click “PLKG System Setup.exe”

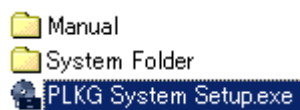

- (3) After open the PLKG System Setup window, select CD-ROM drive and USB memory drive respectively.

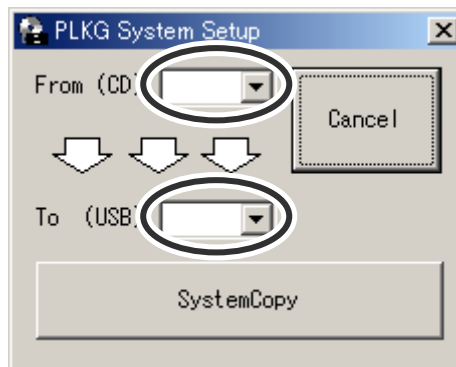

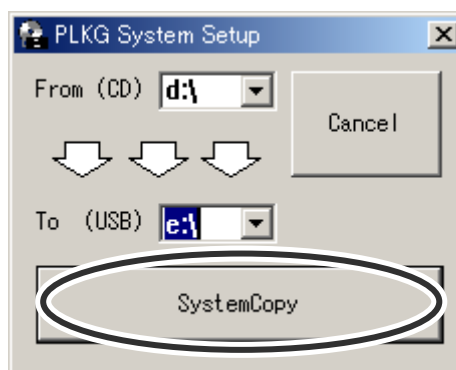

- (4) Click the “SystemCopy” button.
Data copy will be executed.



- (5) When copying is complete, the message will be appeared, then click OK button.
Press  button to close the window.
- (6) The system data copy to USB memory is completed. Please confirm the content of USB memory. Please use this USB memory for system installation.

[System data save to USB memory (manual operation)]

[Outline] Copy the [ PLKG_system] folder where the installed system datas are included, into the root directory of USB memory.
However, before installation to the sewing machine, please change the attribute of the data in the following way.

- (1) Insert CD-ROM(PLK-G Document CD) to the CD drive of the computer.
Insert the USB memory that system data will be preserved.
- (2) [ PLKG_system] folder exists under "System Folder". Copy the folder onto the root directory of USB memory.
- (3) Left-click the [ PLKG_system] with the mouse.
- (4) Click the [File] – [Properties] on the menu bar.

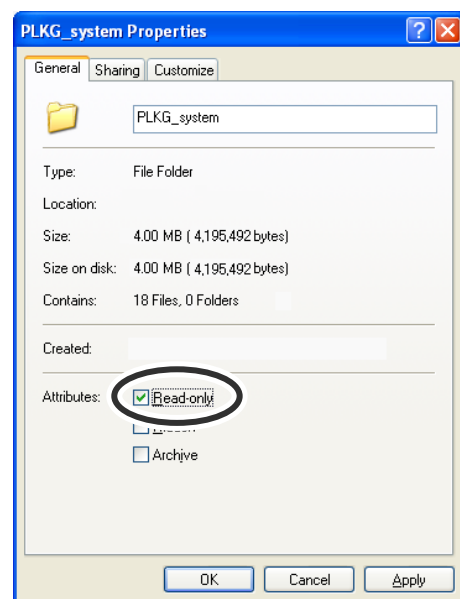
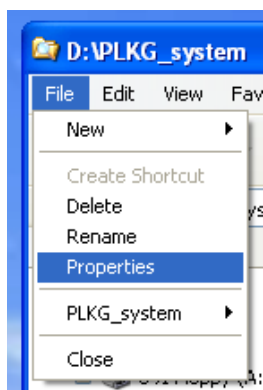

- (5) Click "Reading exclusive use" and then, clear the check box. (make the check box blank).
Then click OK button.

- (6) Choose "The change is applied to this folder, the subfolder, and the file", and click OK button.

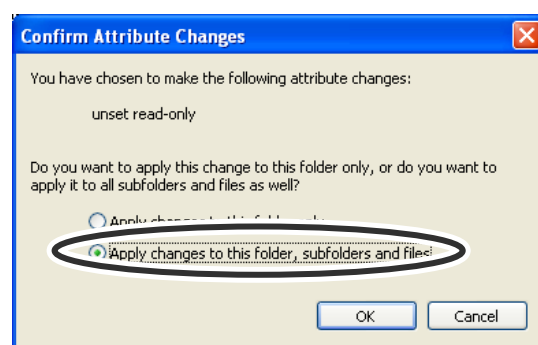

- (7) Attribute change complete. Please use this USB memory for system installation.

This page is blank.

[11] Several power supply

1. 3Ø AC200V - 240V 50/60Hz

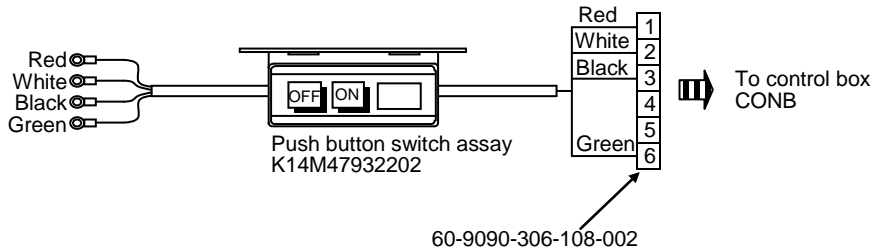

2. 1Ø AC200V - 240V 50/60Hz (Except Europe)

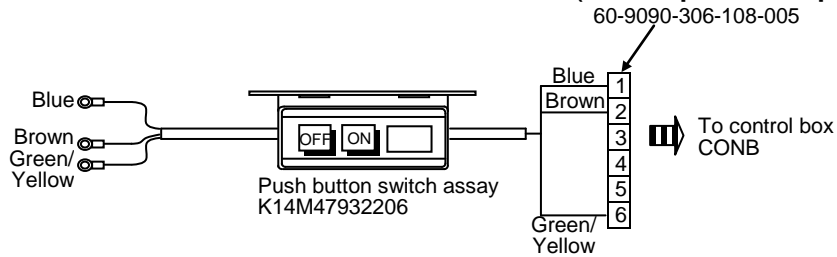

[11] - 1

3. 3Ø AC380V - 415V 50/60Hz (Except Europe)

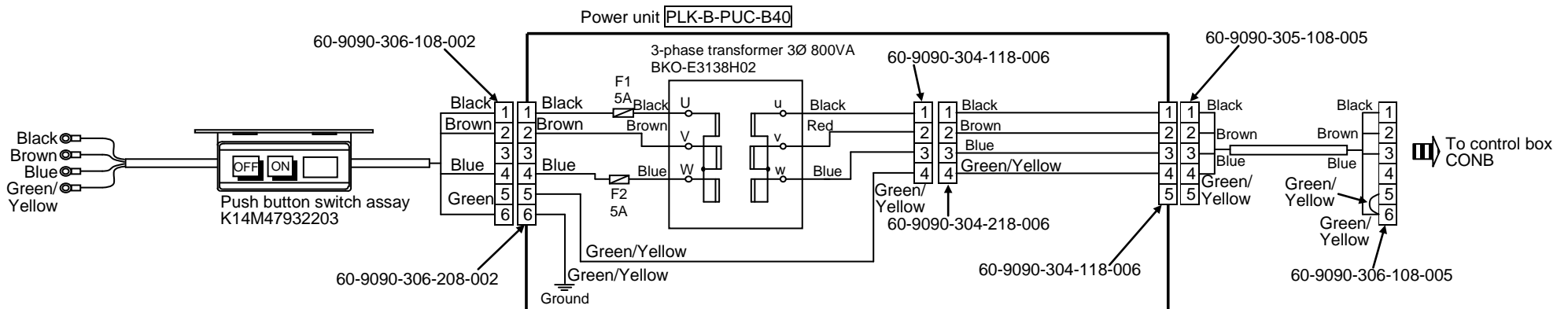

4. 1Ø AC100V - 120V 50/60Hz

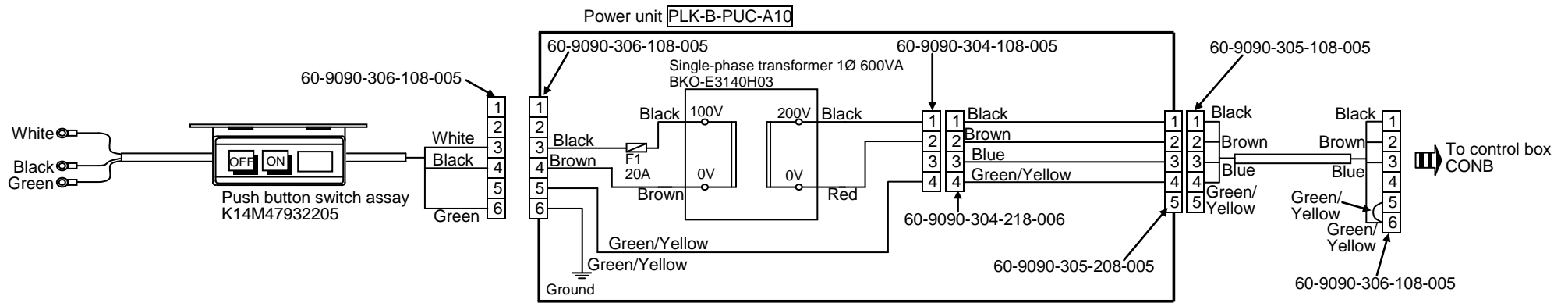

5. 1Ø AC200V - 240V 50/60Hz (Europe)

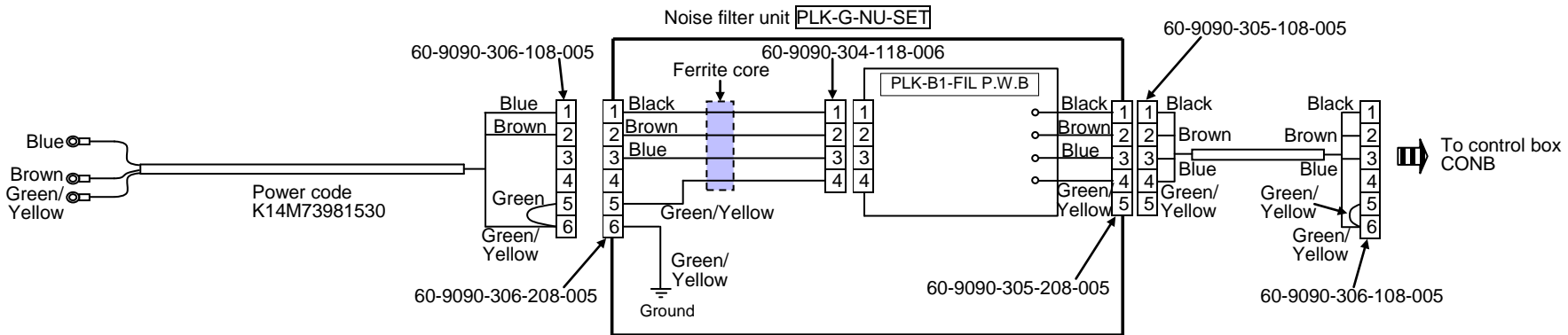

[1]-2

[12] Unit wiring diagram

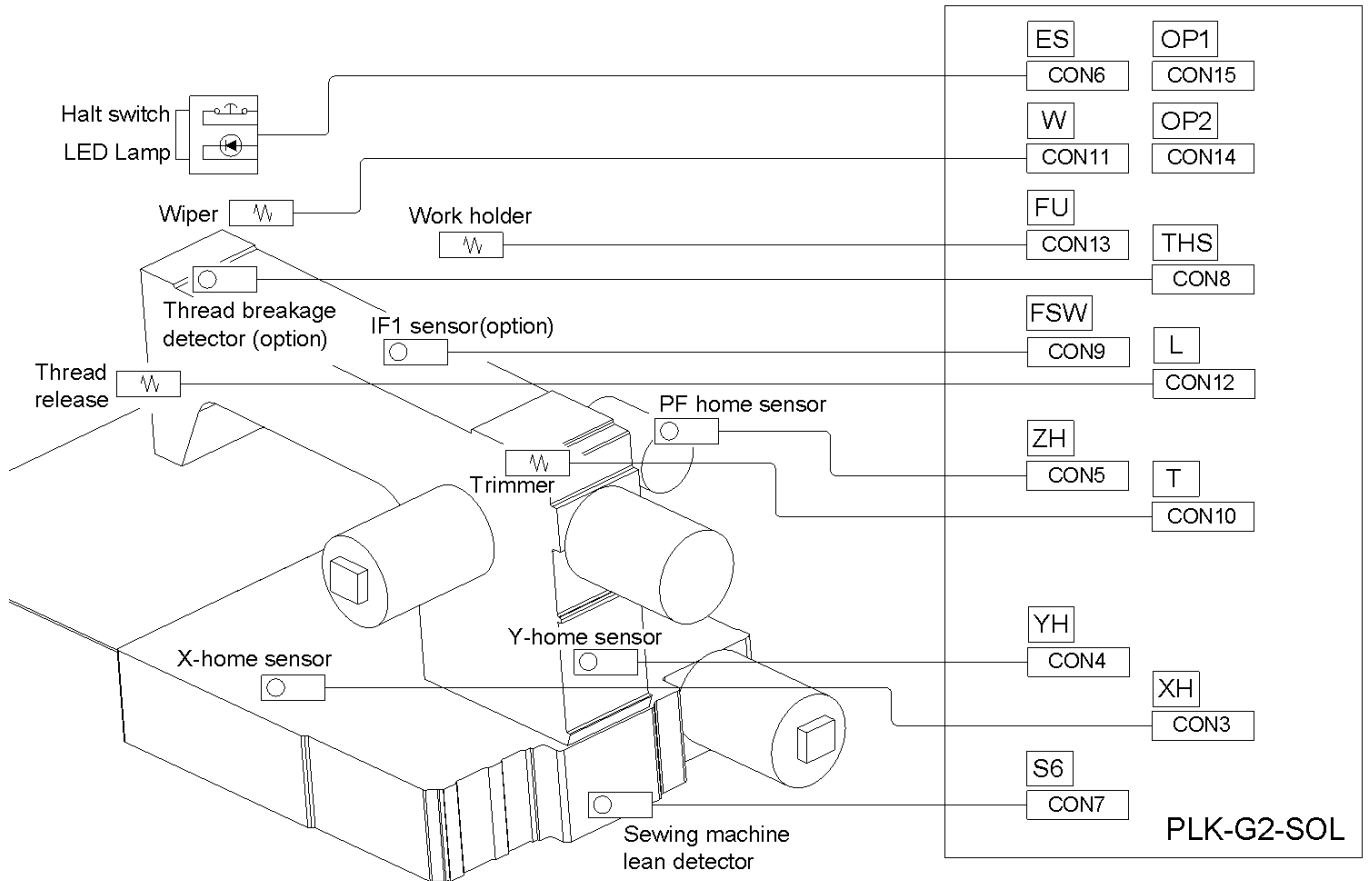

■For connector pin details, refer to “[13] Connectors Layout” and “[14] Pin Number of Connectors.”

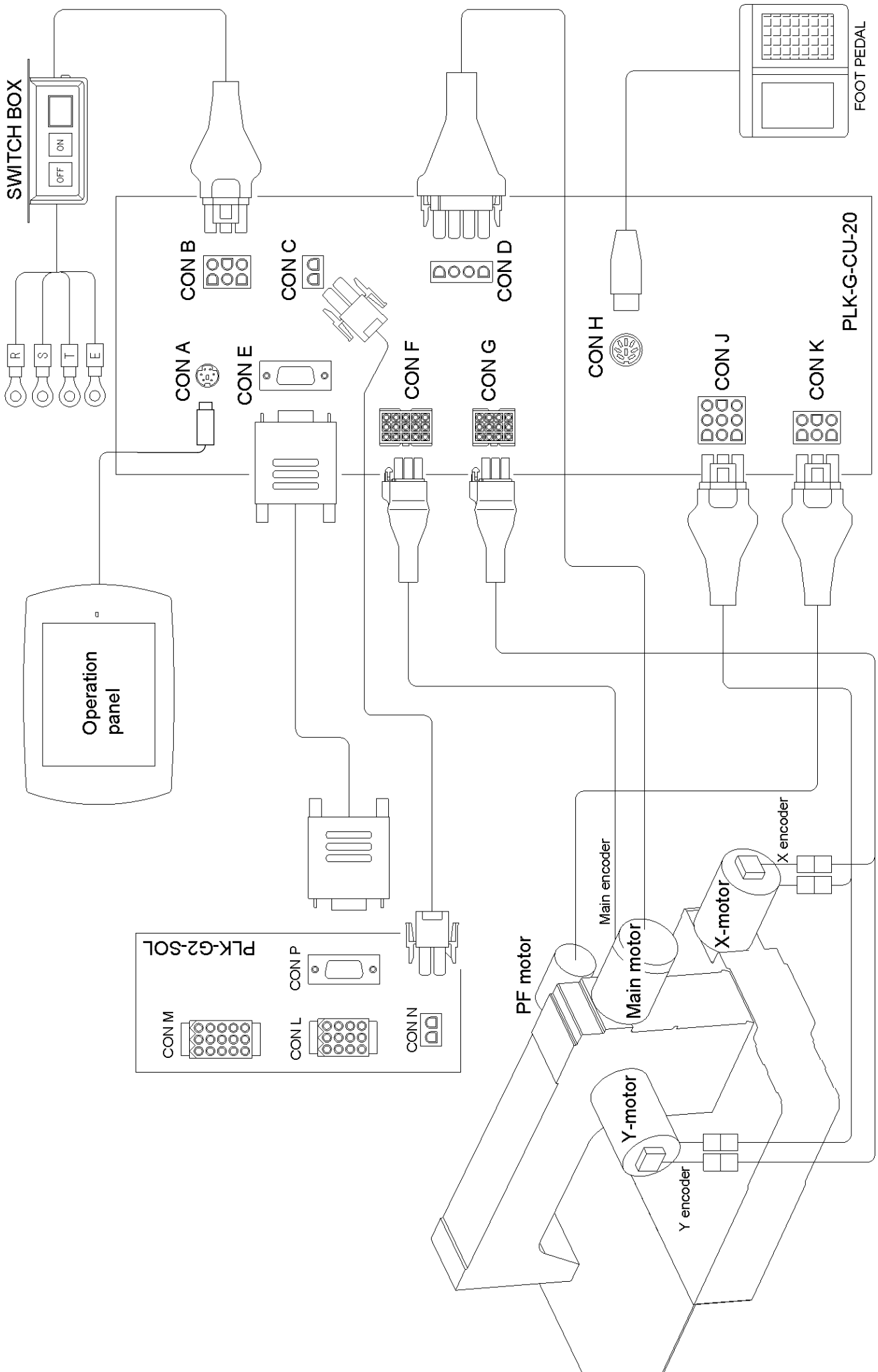

[13] Connectors layout

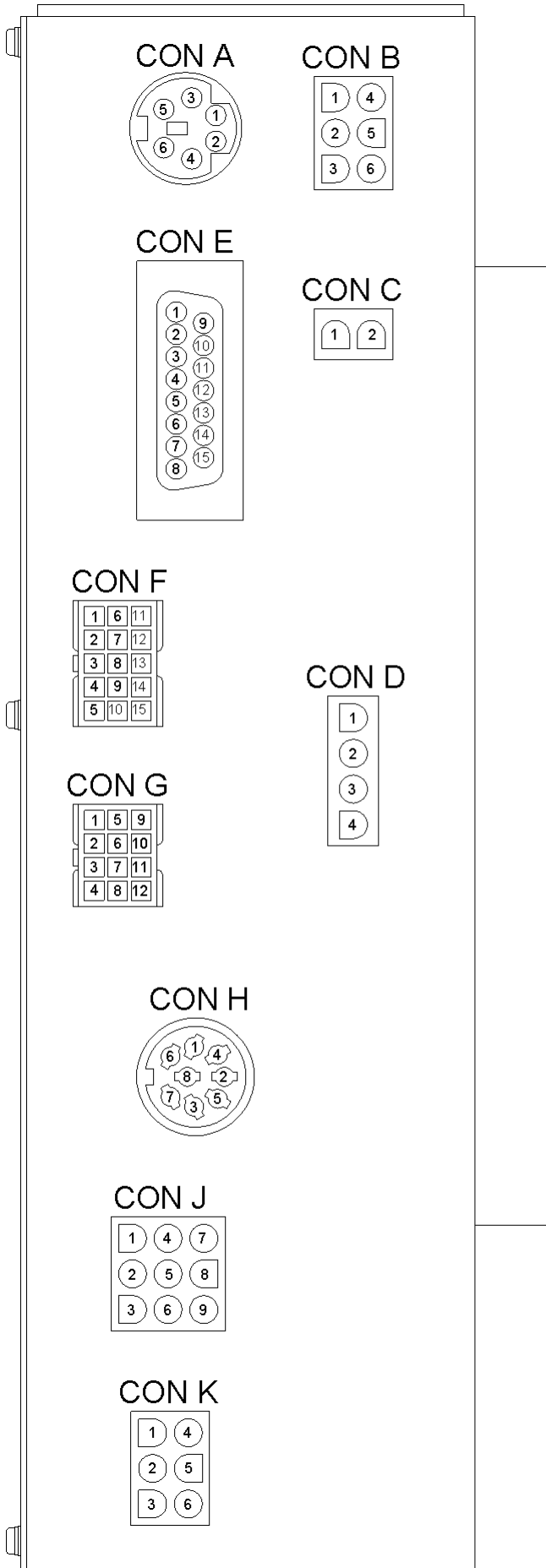

[Back side of control box]

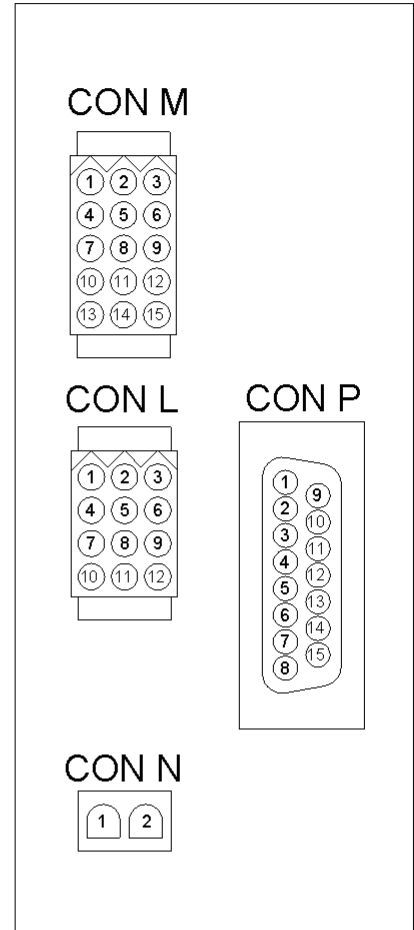

[Back side of machine head]

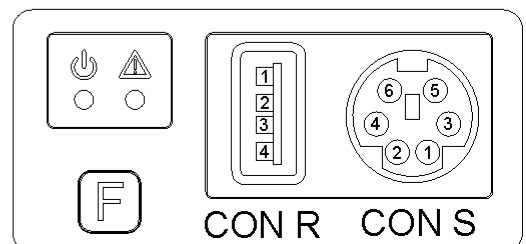

[front panel of the control box]

[14] Pin number of connectors

1. Back side of control box/sewing machine

CONA (Operation panel)

Signal	Pin No.
RXD-IO	1
RXD-PAL	2
TXD-IO	3
GND	4
+12V	5
TXD-PAL	6

CONB (Power supply)

Signal	Pin No.
R	1
S	2
T	3
-	4
E	5
FG	6

CONC (DC power supply for various solenoids (same for CONN))

Signal	Pin No.
+24V	1
GND	2

COND (Main axis servo motor)

Signal	Pin No.
W	1
U	2
V	3
FG	4

CONE (Various solenoids (same for CONP))

Signal	Pin No.
+12V	1
SCL OUT	2
SDA OUT	3
GND	4
+12V	5
SCL IN	6
SDA IN	7
GND	8
X HOME	9
Y HOME	10
Z HOME	11
STP	12
SCL OFF	13
SCL_TE	14
SDA_TE	15

CONF (Main axis encoder)

Signal	Pin No.
GND	1
UP	2
DN	3
+5V	4
FG	5
EA	6
ERA	7
EB	8
ERB	9
-	10
EZ	11
ERZ	12
EU	13
EV	14
EW	15

CONG (XY axis encoder)

Signal	Pin No.
GND	1
+5V	2
GND	3
FG	4
ENXAN	5
ENXBN	6
ENYAN	7
ENYBN	8
ENXAP	9
ENXBP	10
ENYAP	11
ENYBP	12

CONH (Foot switch)

Signal	Initial setting	Pin No.
+12V	+12V	1
I1	[SRT] Start input	2
I2	[IF1] Work holder output 1	3
VC1	ANI1 Analog input	4
GND	GND	5
GND	GND	6
I3	[IF2] Work holder output 2	7
GND	GND	8

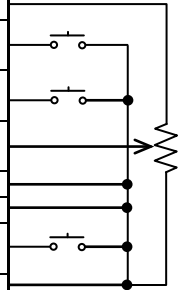

CONJ (XY axis stepping motor)

Signal	Pin No.
XA1	1
XA2	2
XB1	3
YA1	4
FG	5
XB2	6
YA2	7
YB1	8
YB2	9

CONK (PF axis stepping motor)

Signal	Pin No.
+24V	1
BR	2
B	3
AR	4
A	5
+24V	6

CONL (General purpose output)

Signal	Initial setting	Pin No.
I8	[NO] No operation	1
GND	GND	2
I9	[NO] No operation	3
IA	[NO] No operation	4
GND	GND	5
IB	[NO] No operation	6
IC	[NO] No operation	7
GND	GND	8
ID	[NO] No operation	9
IE	[NO] No operation	10
GND	GND	11
IF	[NO] No operation	12

CONR (USB)

Signal	Pin No.
VBUS	1
DM	2
DP	3
GND	4

CONS (RS-232C)

Signal	Pin No.
RXD1	1
RXD0	2
TXD1	3
GND	4
+12V	5
TXD0	6

CONM (General purpose output)

(Output for solenoid valve. The solenoid cannot be driven.)

Signal	Initial setting	Pin No.
O8	[FN1] Function code 1	1
+24V	+24V	2
O9	[FN2] Function code 2	3
OA	[NO] No operation	4
+24V	+24V	5
OB	[NO] No operation	6
+24V	+24V	7
+24V	+24V	8
+24V	+24V	9
OC	[NO] No operation	10
+24V	+24V	11
OD	[NO] No operation	12
OE	[NO] No operation	13
+24V	+24V	14
OF	[NO] No operation	15

*Refer 「3. Ratings value of output」 P.[14]-3, for the ratings of solenoid valve

2. PLK-G2-SOL

(1)Input

CON3

Printed character	Signal		Pin No.
XH	GND	Ground	1
	XHOME	X axis home position detection	2
	+12V	DC12V power supply	3

CON4

Printed character	Signal		Pin No.
YH	GND	Ground	1
	GND	Ground	2
	YHOME	Y axis home position detection	3
	+12V	DC12V power supply	4

CON5

Printed character	Signal		Pin No.
ZH	GND	Ground	1
	GND	Ground	2
	GND	Ground	3
	ZHOME	PF axis home position detection	4
	+12V	DC12V power supply	5

CON6

Printed character	Signal		Pin No.
ES	I4	[STP] Halt switch	1
	GND	Ground	2
	+12V	DC12V power supply	3
	O6	[SSW] Halt stop output	4

CON7

Printed character	Signal		Pin No.
S6	+12V	DC12V power supply	1
	I5	[HES] Mahine tilting detection input	2
	GND	Ground	3

CON8

Printed character	Signal		Pin No.
THS	+12V	DC12V power supply	1
	I6	[THS] Thread breakage detection input	2
	GND	Ground	3
	GND	Ground	4
	GND	Ground	5

CON9

Printed character	Signal		Pin No.
FSW	+12V	DC12V power supply	1
	I7	[NO] No operation	2
	GND	Ground	3

(2)Output

CON10

Printed character	Signal		Pin No.
T	O1	[T] Trim	1
	+24V	DC24V power supply	2

CON11

Printed character	Signal		Pin No.
W	O2	[W] Wiper	1
	-	-	2
	+24V	DC24V power supply	3

CON12

Printed character	Signal		Pin No.
L	O3	[L] Thread release	1
	+24V	DC24V power supply	2

CON13

Printed character	Signal		Pin No.
FU	O4	[OF1] Work holder	1
	+24V	DC24V power supply	2

CON14

Printed character	Signal		Pin No.
OP2	O7	[NO] No operation	1
	-	-	2
	+24V	DC24V power supply	3

* When the error occurs, outputs are turned off. However, "O4" and "O5" output do not turned off except overcurrent error situation.

CON15

Printed character	Signal		Pin No.
OP1	O5P	[OF2] Clamp 2 output(-)	1
	-	-	2
	O5N	[OF2] Clamp 2 output(+)	3

3. Ratings value of output

(1)Ragings value of the solenoid valve output

Output	Name	Power	Resistance	Ratings
O1	T	DC24V	6Ω or more	Moment
O2	W	DC24V	6Ω or more	Moment
O3	L	DC24V	10Ω or more	Moment
O4	FU	DC24V	6Ω or more	Continuity (Note1)
O5	OP1	DC24V	12Ω or more (Note2)	Continuity (Note1)
O7	OP2	DC24V	12Ω or more (Note2)	Continuity (Note1)

(Note 1) Continuity ratings is available when chopping duty is set to 33% or lower.

(Note 2) When neither OP1 nor OP2 are output simultaneously, it is possible to use these resistance 6 ohms or more.

(2)Ratings value for solenoid valve

Output	Power	Maximum ratings current
O8 ~ OF	DC24V	Output total 0.5A or less (Note 3)

(Note 3) Total maximum ratings current for solenoids and solenoid valves is 3.0A.

(3) Output for display light or buzzer

Output	Name	Pwer	Maximum ratings current
O6	ES	DC12V	0.1A or less

[15] Wiring diagram inside control box

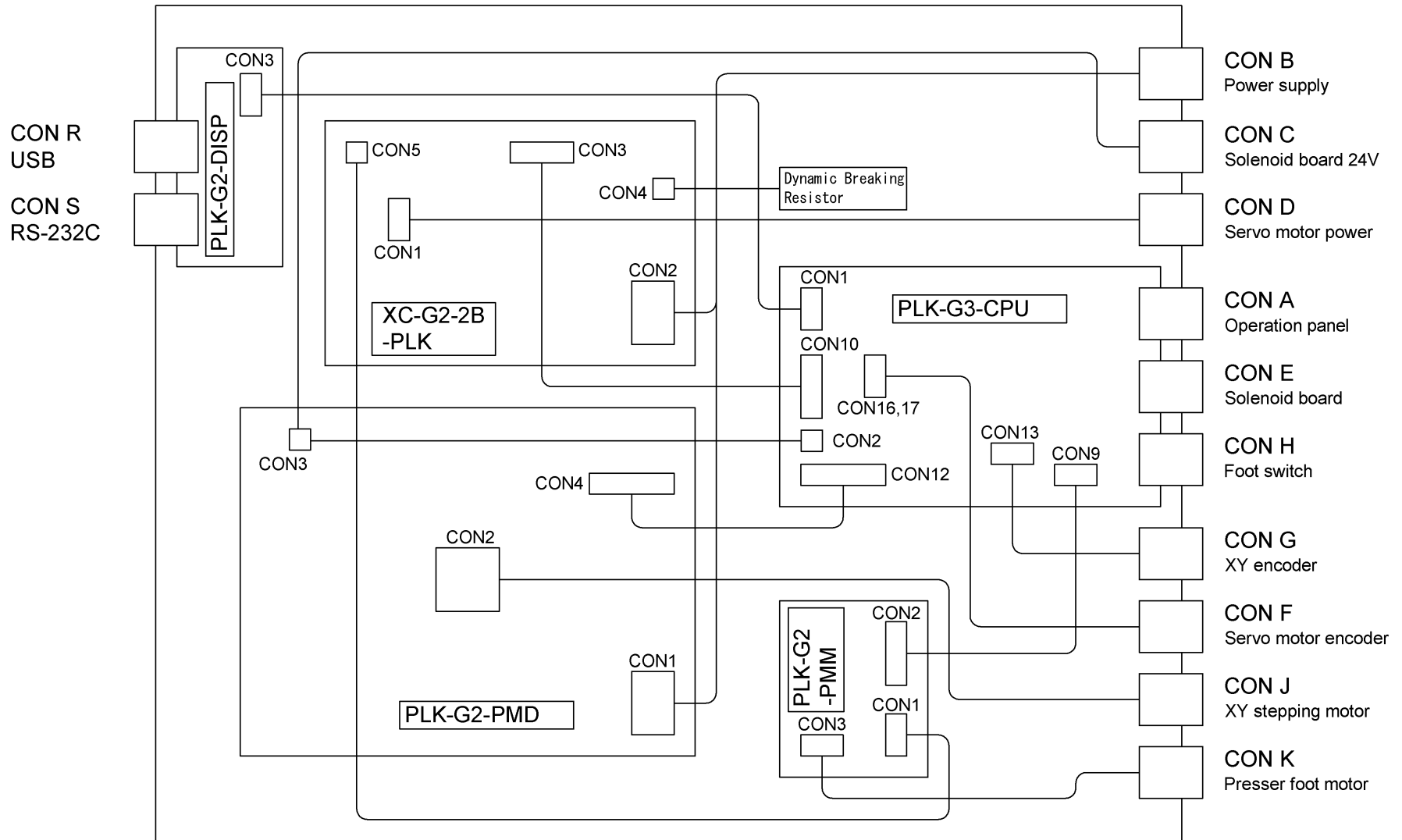

[15] - 1

[16] Specifications

Power source		100~120V Single phase 50/60Hz	200~240V Single phase / 3-phase 50/60Hz	200~240V Single phase / 3-phase (Europe) 50/60Hz	380~415V 3-phase 50/60Hz
Specifications					
Power unit		PLK-B-PUC- A10	-	-	PLK-B-PUC- B40
Noise filter unit		-	-	PLK-G-NU- SET	-
Main motor	Model name	XL-K756-20			
	Rated output	750W			
	Rated speed	3,000rpm			
Control box	Model name	PLK-G-CU-20			
	Rated output	DC 24V			
Condition	Power source	1KVA			
	Range of rating voltage	±10%			
	Ambient temperature	5°C ~ 35°C			
	Ambient humidity	45% ~ 85%			

MITSUBISHI ELECTRIC CORPORATION

Printed in Japan

From the library of Superior Sewing Machine & Supply LLC - www.supsew.com