

W200P

Small Cylinderbed Interlock Stitch Machines
小径シリンダーベッド型偏平縫いミシン

Parts Catalog



パーツカタログの見方

- このパーツカタログは、2020年06月製造中のW200Pシリーズのミシンを掲載しています。
- ゲージパーツの部品番号はゲージパーツ表に記載しています。
- 部品を御注文いただく時は、部品番号を明示してください。なお、右頁のパーツリストに部品番号の記載のない部品は販売できません。
- このパーツカタログの記載事項は改良により、予告なく変更されることがありますので、あらかじめご了承ください。

INTRODUCTION

- This parts catalog covers the W200P series machine manufactured in June, 2020.
- Gauge part numbers which vary depending on subclasses. Please refer to the gauge part list.
- In order to place an order for any part, you must specify the part number. However, parts that are not included in the parts list on the right page cannot be sold.
- Note that the contents of this book are subject to change for improvement without prior notice.

掲載機種 (Models inserted)

W264P Series

| |
|---------------|
| W264P-01CB |
| W264HP-01GB |
| W264P-01NC |
| W264P-03FB |
| W264P-03GB |
| W264P-08AB,AC |
| W264P-08BB,BC |
| W264P-08MC |

| |
|------------|
| W264P-35BB |
| W264P-35NB |
| |
| |
| |
| |
| |
| |
| |
| |
| |

● W200P

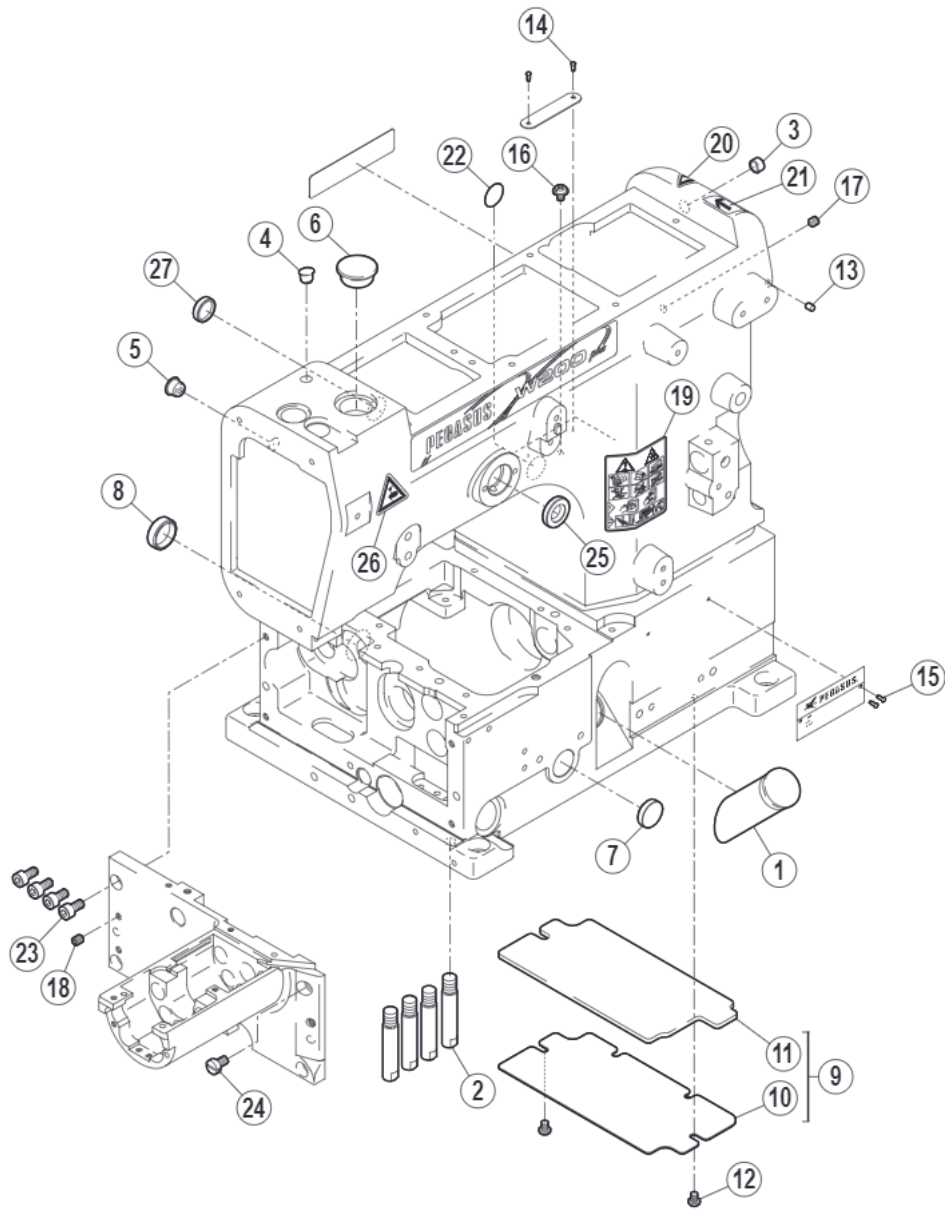







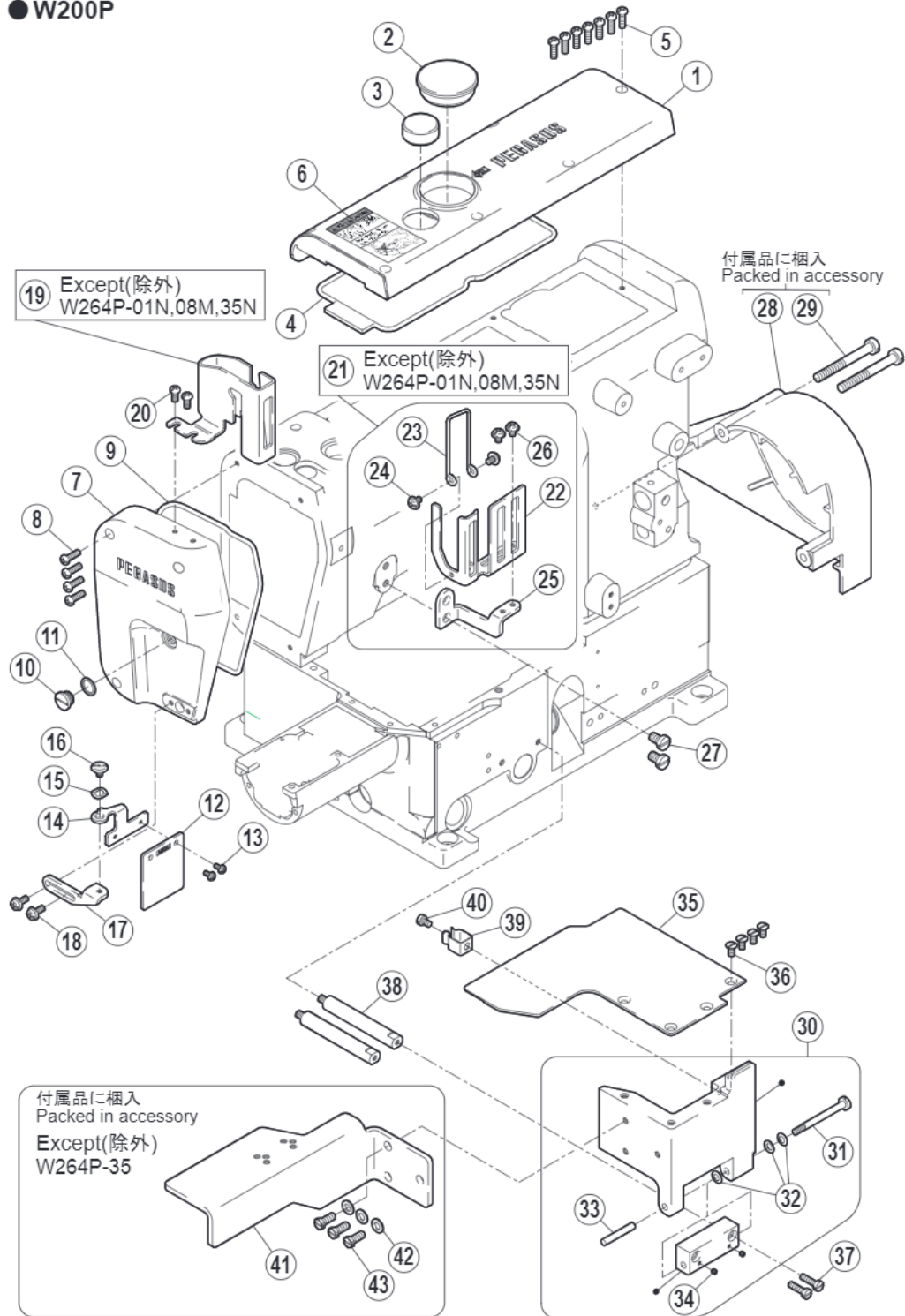

| NO. | PARTS NO. | QTY. | 360° IMAGE | INTO MYLIST |
|-----|---------------------------------|------|---------------|-------------|
| 1 | 206590000009 OIL SIGHT GAUGE | 1 | | |
| 2 | 250117000009 SHOULDER PIN | 4 | | |
| 3 | 240228000009 PLUG | 1 | | |
| 4 | 240052000009 PLUG | 1 | | |
| 5 | 240227000009 PLUG | 1 | | |
| 6 | 240110000009 PLUG | 1 | | |
| 7 | 210003000019 PLUG | 1 | | |
| 8 | 209084000009 PLUG | 1 | | |
| 9 | 250158-91009 COVER ASSY | 1 | | |
| 10 | 250020000009 COVER | 1 | | |
| 11 | 250157000009 SPONGE | 1 | | |
| 12 | 007017A00009 SCREW | 2 | | |
| 13 | 240127000009 MARK | 1 | | |
| 14 | 210679000009 PIN | 2 | « » | |











| NO. | PARTS NO. | QTY. | 360° IMAGE | INTO MYLIST |
|-----|--------------------------|------|---------------|-------------|
| 15 | 210679000009 PIN | 2 | | |
| 16 | 1B00710HZ009 SCREW | 1 | | |
| 17 | 004541000009 SCREW | 1 | | |
| 18 | 004539000009 SCREW | 1 | | |
| 19 | 9A3126000009 LABEL | 1 | | |
| 20 | 9A3046000009 SEAL | 1 | | |
| 21 | 9A3072000009 SEAL | 1 | | |
| 22 | 9A3071000009 SEAL | 1 | | |
| 23 | 004500000009 BOLT | 4 | | |
| 24 | 007027000009 SCREW | 1 | | |
| 25 | 210586000009 OIL SEAL | 1 | | |
| 26 | 9A3046000009 SEAL | 1 | | |
| 27 | 208173000019 PLUG | 1 | | |

<< >>











● W200P



| NO. | PARTS NO. | QTY. | 360° IMAGE | INTO MYLIST |
|-----|----------------------------------|------|---|-------------|
| 1 | 250150-PD019 ARM COVER (TOP) | 1 | | |
| 2 | 240226000019 PLUG | 1 |  | |
| 3 | 6R0001000009 OIL SIGHT WINDOW | 1 | | |
| 4 | 250019000009 O RING | 1 |  | |
| 5 | 007021A00009 SCREW | 7 | | |
| 6 | 9A3081000009 CAUTION LABEL | 1 | | |
| 7 | 250151BTD019 ARM COVER (LEFT) | 1 | | |
| 8 | 007021A00009 SCREW | 4 | | |
| 9 | 250153000009 O RING | 1 |  | |
| 10 | 005242000009 SCREW | 1 | | |
| 11 | 240263000009 WASHER | 1 |  | |
| 12 | 250257000009 EYE GUARD | 1 |  | |
| 13 | 1B00700HZ009 SCREW | 2 |  | |
| 14 | 250256000009 BRACKET | 1 |  | |

| NO. | PARTS NO. | QTY. | 360° IMAGE | INTO MYLIST |
|-----|---|------|---|-------------|
| 15 | 210307000009 SPRING WASHER | 1 |  | |
| 16 | 007066000009 SCREW | 1 | | |
| 17 | 250255000009 BRACKET | 1 |  | |
| 18 | 1B00730HZ009 SCREW | 2 |  | |
| 19 | 250224A00009 SAFETY COVER | 1 |  | |
| 20 | 007019A00009 SCREW | 2 | | |
| 21 | 250231A91009 THREAD TAKE-UP GUARD ASSY | 1 |  | |
| 22 | 250225000009 SAFETY COVER | 1 |  | |
| 23 | 250226000009 FINGER GUARD | 1 |  | |
| 24 | 1B00710HZ009 SCREW | 2 |  | |
| 25 | 250227A00009 BRACKET | 1 | | |
| 26 | 1B00710HZ009 SCREW | 2 |  | |
| 27 | 007052000009 SCREW | 2 |  | |
| 28 | 250022ETB009 PULLEY COVER | 1 | | |







« 1 »

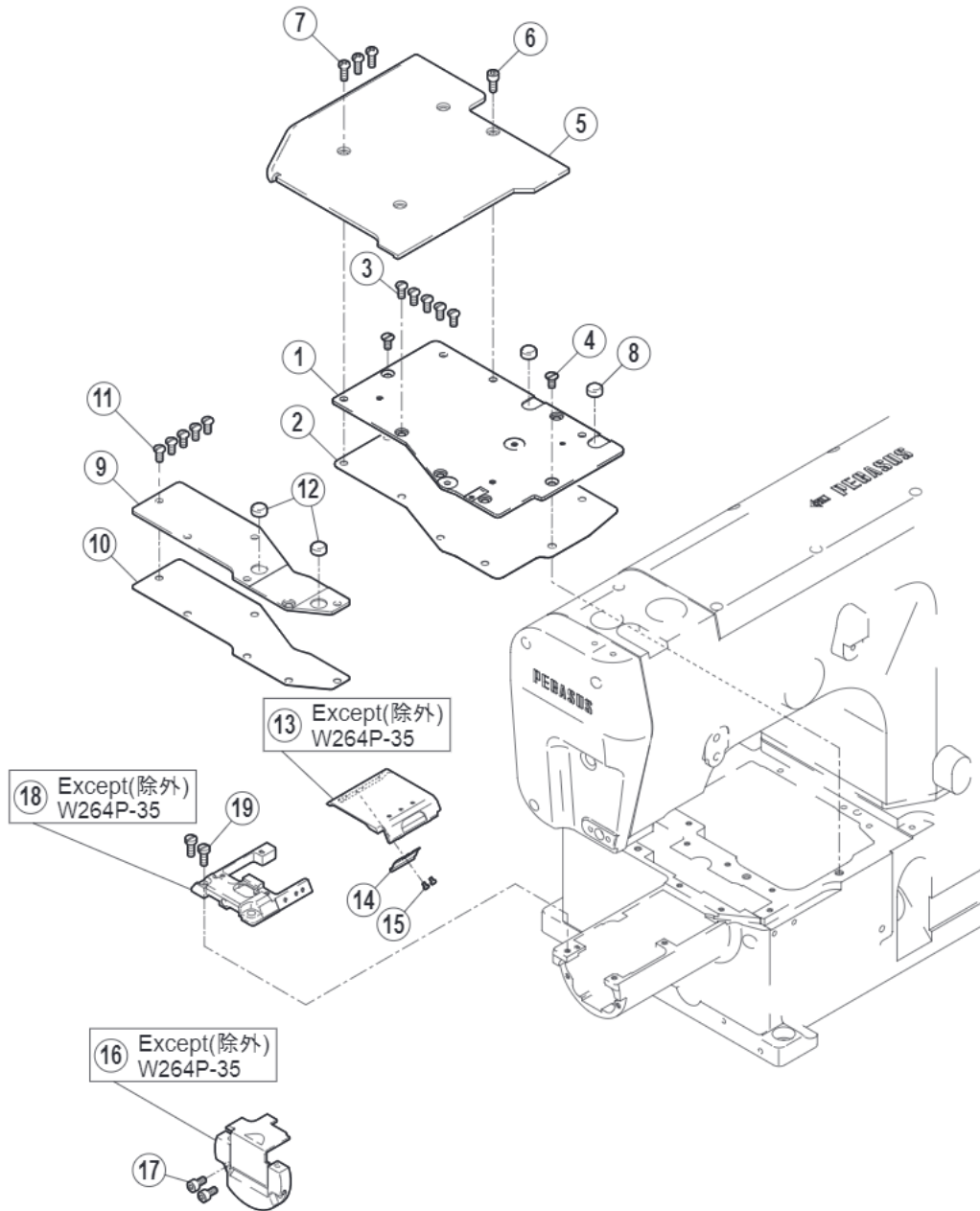



| NO. | PARTS NO. | QTY. | 360° IMAGE | INTO MYLIST |
|-----|---|------|---|-------------|
| 29 | 007075000009 SCREW | 2 |  | |
| 30 | 6C00260PD009 FRONT COVER | 1 | | |
| 31 | 250013000009 SCREW | 1 |  | |
| 32 | 201191000009 SPRING WASHER | 3 |  | |
| 33 | 240198000009 PIN | 1 |  | |
| 34 | 004554000009 SCREW | 2 | | |
| 35 | 2503990PD009 AUXILIARY PLATE | 1 | | |
| 36 | 007043000009 SCREW | 4 |  | |
| 37 | 007022000009 SCREW | 2 |  | |
| 38 | 250301000009 SCREW | 2 |  | |
| 39 | 250300000009 FLAT SPRING | 1 |  | |
| 40 | 007018000009 SCREW | 1 |  | |
| 41 | 250425000009 AUXILIARY COVER (FRONT) | 1 | | |
| 42 | 204585000009 WASHER | 3 |  | |

| NO. | PARTS NO. | QTY. | 360° IMAGE | INTO MYLIST |
|-----|----------------------|------|---|-------------|
| 43 | 004580000009 BOLT | 3 |  | |

● W200P









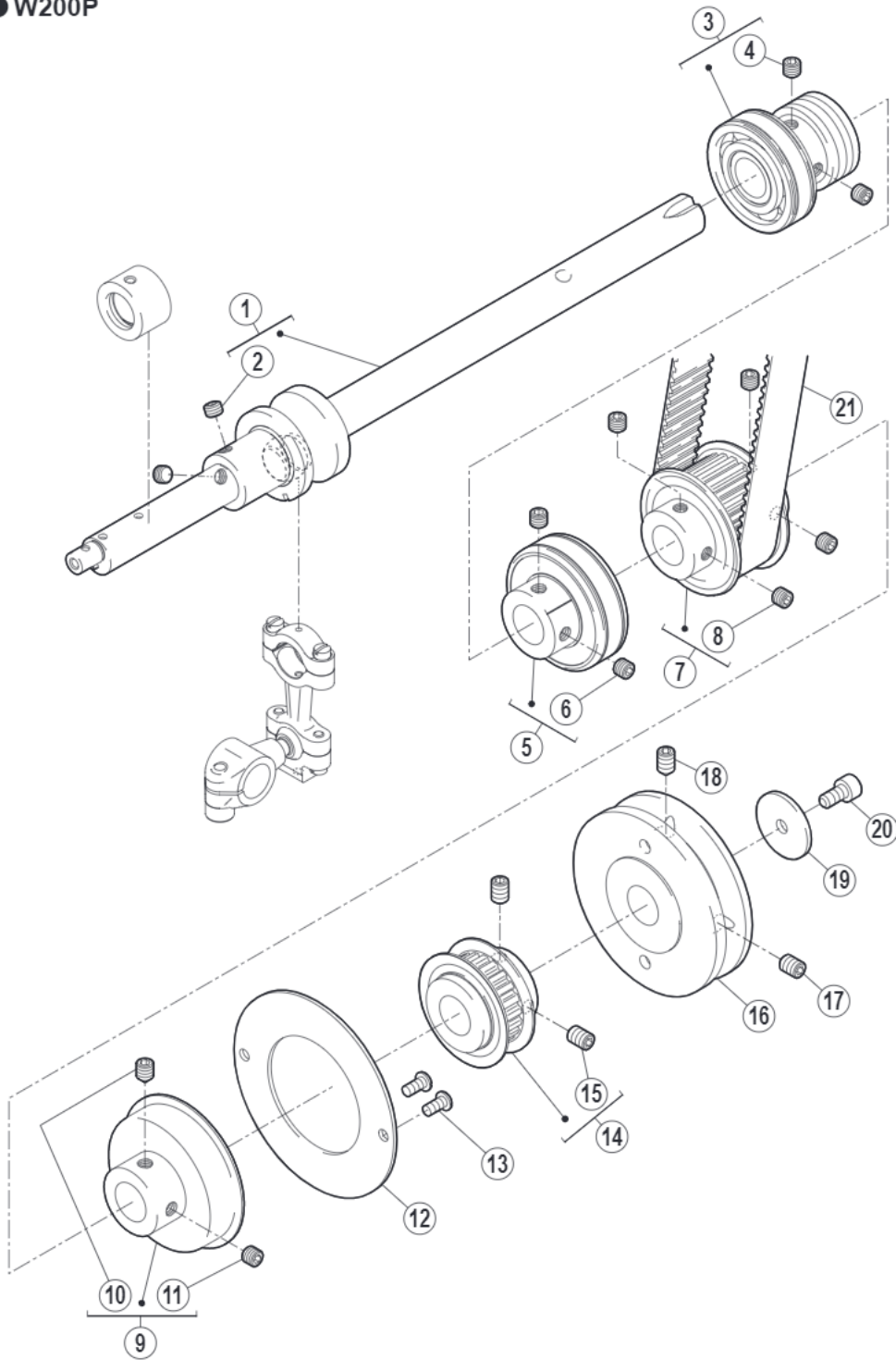





| NO. | PARTS NO. | QTY. | 360° IMAGE | INTO MYLIST |
|-----|--|------|---|-------------|
| 1 | 352179000009 TOP COVER (RIGHT) | 1 |  | |
| 2 | 250402000019 GASKET | 1 | | |
| 3 | 007082000009 SCREW | 5 |  | |
| 4 | 007043000009 SCREW | 2 |  | |
| 5 | 250411-PD009 BED COVER | 1 | | |
| 6 | 004524000009 BOLT | 1 |  | |
| 7 | 007020A00009 SCREW | 3 | | |
| 8 | 250421000009 RUBBER CUSHION | 2 |  | |
| 9 | 250403000009 TOP COVER PLATE (LEFT) | 1 | | |
| 10 | 250404000019 GASKET | 1 | | |
| 11 | 007082000009 SCREW | 5 |  | |
| 12 | 250421000009 RUBBER CUSHION | 2 |  | |
| 13 | 250416000009 COVER | 1 |  | |
| 14 | 250417000009 FLAT SPRING | 1 |  | |

| NO. | PARTS NO. | QTY. | 360° IMAGE | INTO MYLIST |
|-----|---------------------------------|------|---|-------------|
| 15 | 007061000009 SCREW | 2 | | |
| 16 | 6E0048091009 SIDE COVER ASSY | 1 |  | |
| 17 | 004527000009 BOLT | 2 |  | |
| 18 | 6A0461091009 BRACKET ASSY | 1 |  | |
| 19 | 007019000009 SCREW | 2 |  | |

● W200P









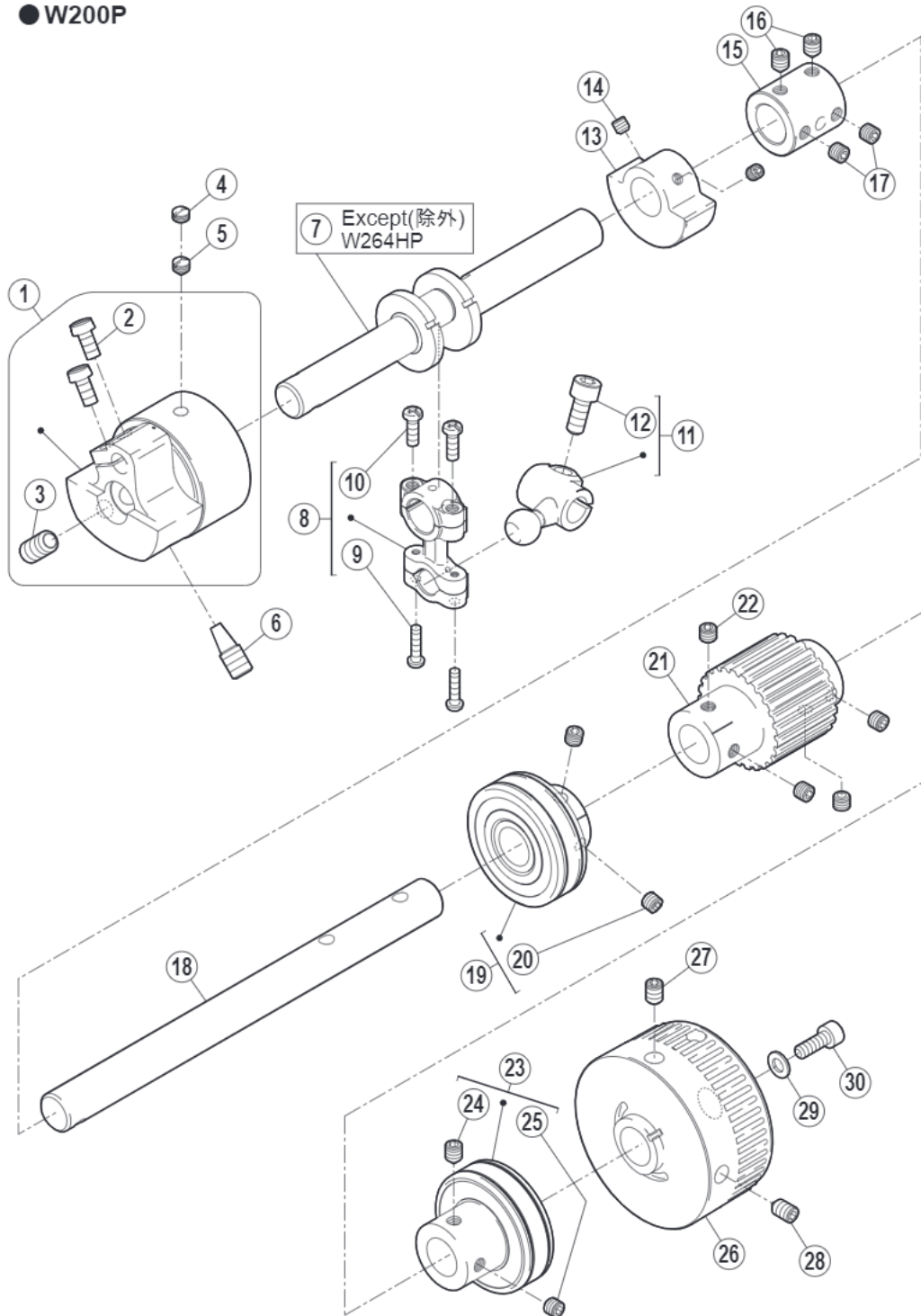













| NO. | PARTS NO. | QTY. | 360° IMAGE | INTO MYLIST |
|-----|-----------------------------------|------|---|-------------|
| 1 | 250572-91009 CRANKSHAFT ASSY | 1 | | |
| 2 | 007128000009 SCREW | 2 | | |
| 3 | 250557-91009 BALL BEARING ASSY | 1 |  | |
| 4 | 004547000009 SCREW | 2 | | |
| 5 | 250529A91009 BALL BEARING ASSY | 1 |  | |
| 6 | 004547000009 SCREW | 2 | | |
| 7 | 250545-91009 GEAR (LOWER) | 1 |  | |
| 8 | 004547000009 SCREW | 4 | | |
| 9 | 250530-91009 BALL BEARING ASSY | 1 |  | |
| 10 | 004555000009 SCREW | 1 |  | |
| 11 | 004547000009 SCREW | 1 | | |
| 12 | 250514000009 COVER | 1 |  | |
| 13 | 007082000009 SCREW | 2 |  | |
| 14 | 250565-91009 GEAR | 1 |  << >> | |



| NO. | PARTS NO. | QTY. | 360° IMAGE | INTO MYLIST |
|-----|--------------------------------|------|---|-------------|
| 15 | 004548000009 SCREW | 2 |  | |
| 16 | 250561A00009 MACHINE PULLEY | 1 |  | |
| 17 | 004541000009 SCREW | 1 |  | |
| 18 | 004556000009 SCREW | 1 |  | |
| 19 | 240126000009 WASHER | 1 |  | |
| 20 | 004500000009 BOLT | 1 |  | |
| 21 | 206050C00019 TIMING BELT | 1 | | |

● W200P



| NO. | PARTS NO. | QTY. | 360° IMAGE | INTO MYLIST |
|-----|--------------------------------|------|---|-------------|
| 1 | 251034-91009 MOTION ASSY | 1 | | |
| 2 | 007028000009 SCREW | 2 |  | |
| 3 | 004592000009 SCREW | 1 |  | |
| 4 | 007152000009 SCREW | 1 |  | |
| 5 | 007153000009 SCREW | 1 | | |
| 6 | 007268000009 SCREW | 1 |  | |
| 7 | 250560A00009 CRANKSHAFT | 1 |  | |
| 8 | 253500-92009 CONNECTION | 1 |  | |
| 9 | 007015A00009 SCREW | 2 |  | |
| 10 | 007021A00009 SCREW | 2 | | |
| 11 | 253501A92009 CRANK | 1 |  | |
| 12 | 004534000009 BOLT | 1 |  | |
| 13 | 250524000009 BALANCE WEIGHT | 1 |  | |
| 14 | 004514000009 SCREW | 2 |  << >> | |





| NO. | PARTS NO. | QTY. | 360° IMAGE | INTO MYLIST |
|-----|-----------------------------------|------|---|-------------|
| 15 | 250506000009 JOINT | 1 |  | |
| 16 | 004555000009 SCREW | 2 |  | |
| 17 | 004547000009 SCREW | 2 | | |
| 18 | 250552000009 SHAFT | 1 |  | |
| 19 | 250529-91009 BALL BEARING ASSY | 1 |  | |
| 20 | 004547000009 SCREW | 2 | | |
| 21 | 250547A00009 GEAR (UPPER) | 1 |  | |
| 22 | 004547000009 SCREW | 4 | | |
| 23 | 250528-91009 BALL BEARING ASSY | 1 |  | |
| 24 | 004555000009 SCREW | 1 |  | |
| 25 | 004547000009 SCREW | 1 | | |
| 26 | 250566-TD009 HANDWHEEL | 1 |  | |
| 27 | 004556000009 SCREW | 1 |  | |
| 28 | 004541000009 SCREW | 1 |  | |



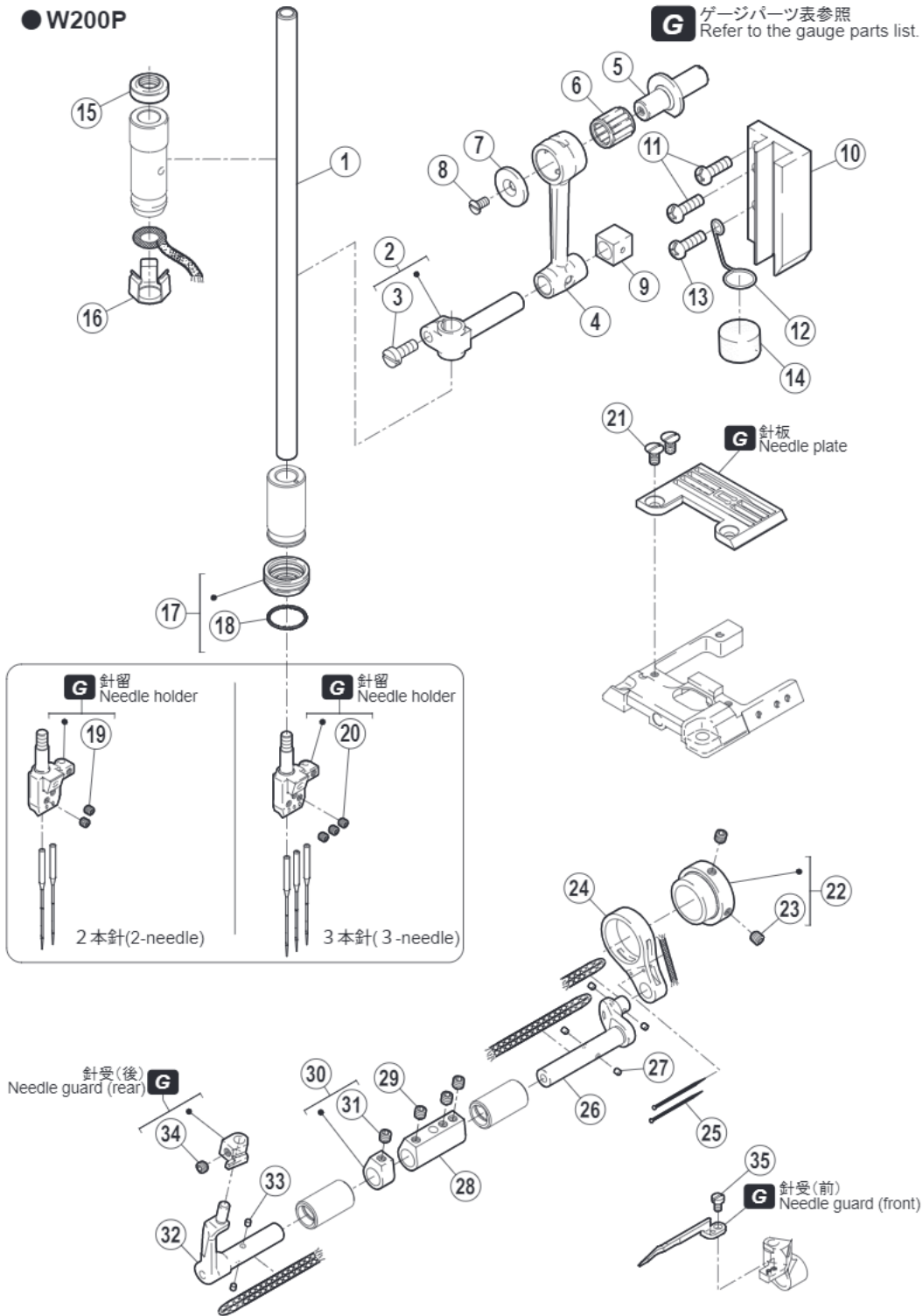







| NO. | PARTS NO. | QTY. | 360° IMAGE | INTO MYLIST |
|-----|------------------------|------|---|-------------|
| 29 | 204585000009 WASHER | 1 |  | |
| 30 | 004501000009 BOLT | 1 |  | |

● W200P

G ゲージパーツ表参照
Refer to the gauge parts list.



| NO. | PARTS NO. | QTY. | 360° IMAGE | INTO MYLIST |
|-----|----------------------------------|------|---|-------------|
| 1 | 251014-91029 NEEDLE BAR | 1 |  | |
| 2 | 261500-92009 NEEDLE BAR CLAMP | 1 |  | |
| 3 | 007020000009 SCREW | 1 |  | |
| 4 | 251016000009 LINK | 1 |  | |
| 5 | 251037000009 ECCENTRIC PIN | 1 |  | |
| 6 | 240098-20009 NEEDLE BEARING | 1 |  | |
| 7 | 205097000009 WASHER | 1 |  | |
| 8 | 007041000009 SCREW | 1 |  | |
| 9 | 206063000009 BLOCK | 1 |  | |
| 10 | 251017000019 GUIDE | 1 |  | |
| 11 | 007021A00009 SCREW | 2 | | |
| 12 | 251018000009 LATCH | 1 |  | |
| 13 | 007021A00009 SCREW | 1 | | |
| 14 | 179040-05009 SPONGE | 1 |  | |









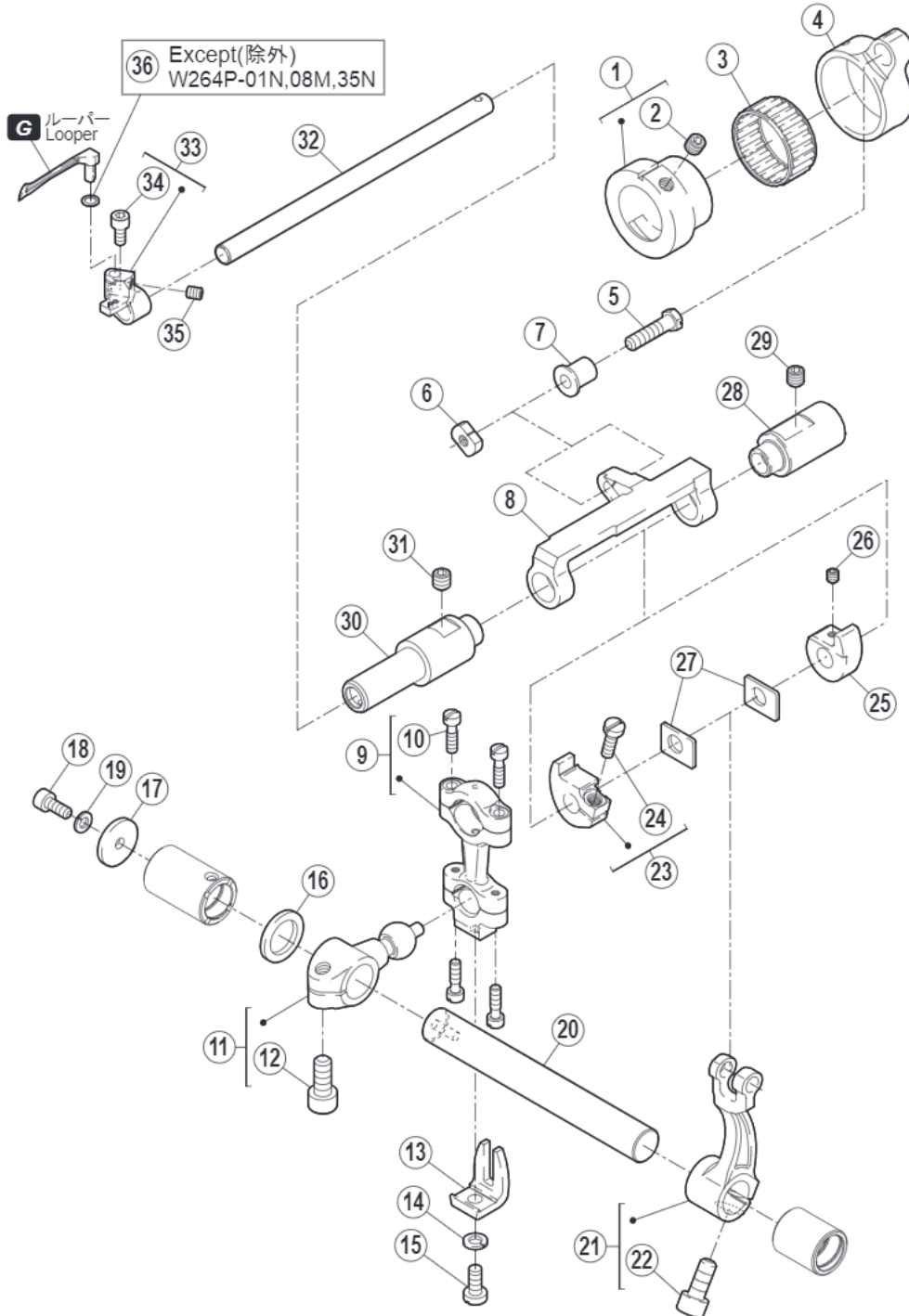



| NO. | PARTS NO. | QTY. | 360° IMAGE | INTO MYLIST |
|-----|-------------------------------|------|---|-------------|
| 15 | 1L0010000009 OIL SEAL | 1 |  | |
| 16 | 206524000009 CLAMP | 1 |  | |
| 17 | 1L0012091Y09 OIL SEAL ASSY | 1 |  | |
| 18 | 1J1039000009 CLAMP | 1 |  | |
| 19 | 004554000009 SCREW | 2 | | |
| 20 | 004554000009 SCREW | 3 | | |
| 21 | 005511-HC009 SCREW | 2 |  | |
| 22 | 251533-92009 ECCENTRIC | 1 |  | |
| 23 | 004543000009 SCREW | 2 |  | |
| 24 | 251534000009 CONNECTION | 1 |  | |
| 25 | 210766000009 PIN | 2 |  | |
| 26 | 251535000009 CRANKSHAFT | 1 |  | |
| 27 | 207925000009 FELT | 4 | | |
| 28 | 251537000009 JOINT | 1 |  | |

| NO. | PARTS NO. | QTY. | 360° IMAGE | INTO MYLIST |
|-----|--|------|---|-------------|
| 29 | 004543000009 SCREW | 3 |  | |
| 30 | 240548-92009 COLLAR | 1 |  | |
| 31 | 004543000009 SCREW | 1 |  | |
| 32 | 251536000009 NEEDLE GUARD HOLDER (REAR) | 1 |  | |
| 33 | 207925000009 FELT | 2 | | |
| 34 | 004599000009 SCREW | 1 | | |
| 35 | 007031000009 SCREW | 1 | | |

● W200P

G ゲージパーツ表参照
Refer to the gauge parts list.



| NO. | PARTS NO. | QTY. | 360° IMAGE | INTO MYLIST |
|-----|--------------------------------|------|---|-------------|
| 1 | 252036-92019 ECCENTRIC | 1 |  | |
| 2 | 004547000009 SCREW | 1 | | |
| 3 | 206172-20009 NEEDLE BEARING | 1 |  | |
| 4 | 4B0041000009 CONNECTION | 1 |  | |
| 5 | 004549000009 BOLT | 1 |  | |
| 6 | 1D0012000009 NUT | 1 |  | |
| 7 | 5A0027000009 BUSHING | 1 |  | |
| 8 | 5K0058000009 GUIDE | 1 |  | |
| 9 | 210091-92009 CONNECTION | 1 |  | |
| 10 | 005376000009 SCREW | 4 |  | |
| 11 | 252056-92009 CRANK | 1 |  | |
| 12 | 004534000009 BOLT | 1 |  | |
| 13 | 201074A00009 GUIDE | 1 |  | |
| 14 | 202286000009 SPRING WASHER | 1 |  | |

| NO. | PARTS NO. | QTY. | 360° IMAGE | INTO MYLIST |
|-----|-------------------------------|------|---|-------------|
| 15 | 005546000009 SCREW | 1 | | |
| 16 | 240231000009 WASHER | 1 |  | |
| 17 | 240232000009 WASHER | 1 |  | |
| 18 | 004524000009 BOLT | 1 |  | |
| 19 | 201252000009 SPRING WASHER | 1 | | |
| 20 | 252044000009 SHAFT | 1 |  | |
| 21 | 4M0040092009 LEVER | 1 |  | |
| 22 | 004534000009 BOLT | 1 |  | |
| 23 | 5K0132092009 HOLDER | 1 |  | |
| 24 | 007021000009 SCREW | 1 |  | |
| 25 | 5K0133000009 HOLDER | 1 |  | |
| 26 | 004546000009 SCREW | 1 | | |
| 27 | 252047000009 WASHER | 2 |  | |
| 28 | 262004000009 BUSHING | 1 |  | |

| NO. | PARTS NO. | QTY. | 360° IMAGE | INTO MYLIST |
|-----|------------------------------------|------|---|-------------|
| 29 | 004522000009 SCREW | 1 |  | |
| 30 | 252077000009 BUSHING | 1 |  | |
| 31 | 004522000009 SCREW | 1 |  | |
| 32 | 4S0082000029 SHAFT | 1 |  | |
| 33 | 252075-91019 LOOPER HOLDER ASSY | 1 |  | |
| 34 | 1B0027000009 BOLT | 1 |  | |
| 35 | 007129000009 SCREW | 1 | | |
| 36 | 240506000009 SPACER | 1 |  | |

● W200P









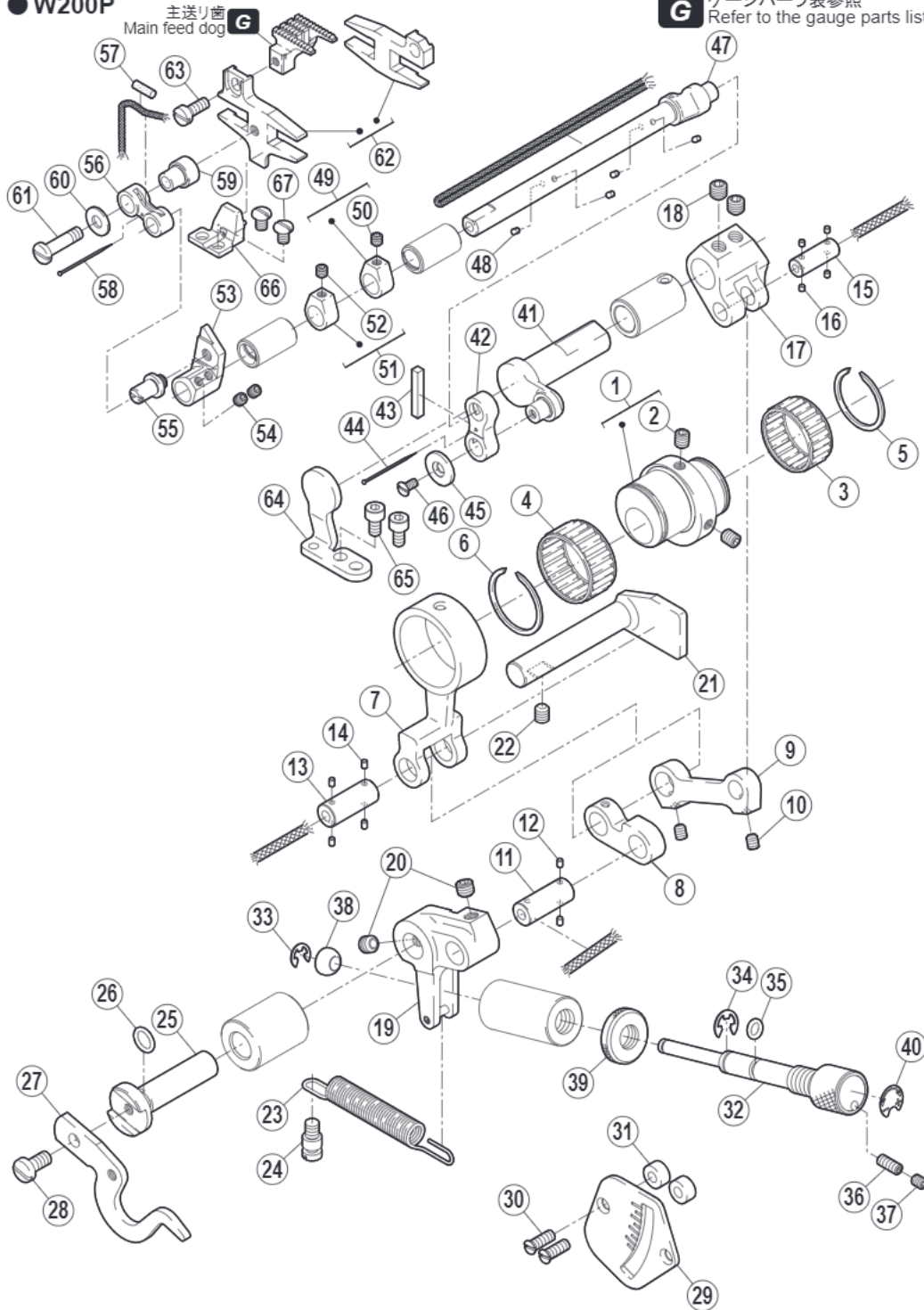

主送り歯
Main feed dog















G













ゲージパーツ表参照
Refer to the gauge parts list.











| NO. | PARTS NO. | QTY. | 360° IMAGE | INTO MYLIST |
|-----|--------------------------------|------|---|-------------|
| 1 | 252607B92019 ECCENTRIC | 1 |  | |
| 2 | 004539000009 SCREW | 2 | | |
| 3 | 204084-20009 NEEDLE BEARING | 1 |  | |
| 4 | 240236-20009 NEEDLE BEARING | 1 |  | |
| 5 | 240234000009 RETAINING RING | 1 |  | |
| 6 | 240237000009 RETAINING RING | 1 |  | |
| 7 | 252612000009 CONNECTION | 1 |  | |
| 8 | 252614000009 LINK | 1 |  | |
| 9 | 252615000009 LINK | 1 |  | |
| 10 | 004537000009 SCREW | 2 | | |
| 11 | 252613000009 SHAFT | 1 |  | |
| 12 | 207358000009 FELT | 2 | | |
| 13 | 252613000009 SHAFT | 1 |  | |
| 14 | 207358000009 FELT | 4 | « » | |

| NO. | PARTS NO. | QTY. | 360° IMAGE | INTO MYLIST |
|-----|------------------------|------|---|-------------|
| 15 | 252616000009 SHAFT | 1 |  | |
| 16 | 207925000009 FELT | 4 | | |
| 17 | 252677000009 CRANK | 1 |  | |
| 18 | 007142000009 SCREW | 2 |  | |
| 19 | 252618-91009 LINK | 1 |  | |
| 20 | 004547000009 SCREW | 2 | | |
| 21 | 252622000009 GUIDE | 1 |  | |
| 22 | 004539000009 SCREW | 1 | | |
| 23 | 252620000009 SPRING | 1 |  | |
| 24 | 007131000009 SCREW | 1 |  | |
| 25 | 252621000009 SHAFT | 1 |  | |
| 26 | 240017000009 O RING | 1 |  | |
| 27 | 252702000009 LEVER | 1 |  | |
| 28 | 007034000009 SCREW | 1 |  << >> | |

| NO. | PARTS NO. | QTY. | 360° IMAGE | INTO MYLIST |
|-----|----------------------------------|------|---|-------------|
| 29 | 252701000009 INDICATION PLATE | 1 |  | |
| 30 | 007083000009 SCREW | 2 |  | |
| 31 | 240321000009 SPACER | 2 | | |
| 32 | 252625000009 SCREW | 1 |  | |
| 33 | 201629000009 RETAINING RING | 1 |  | |
| 34 | 200983000009 RETAINING RING | 1 |  | |
| 35 | 240251000009 O RING | 1 |  | |
| 36 | 004550000009 SCREW | 1 |  | |
| 37 | 004537000009 SCREW | 1 | | |
| 38 | 252626000009 LINER | 1 |  | |
| 39 | 252660000009 NUT | 1 |  | |
| 40 | 252671000009 SEAL | 1 |  | |
| 41 | 252678000009 CRANKSHAFT | 1 |  | |
| 42 | 252679000009 LINK | 1 |  << >> | |

| NO. | PARTS NO. | QTY. | 360° IMAGE | INTO MYLIST |
|-----|----------------------------|------|---|-------------|
| 43 | 240139000009 FELT | 1 | | |
| 44 | 210766000009 PIN | 1 |  | |
| 45 | 240055000009 WASHER | 1 |  | |
| 46 | 007041000009 SCREW | 1 |  | |
| 47 | 252680000009 CRANKSHAFT | 1 |  | |
| 48 | 207358000009 FELT | 4 | | |
| 49 | 240549-92009 COLLAR | 1 |  | |
| 50 | 004543000009 SCREW | 1 |  | |
| 51 | 240549-92009 COLLAR | 1 |  | |
| 52 | 004543000009 SCREW | 1 |  | |
| 53 | 252706000009 CRANK | 1 |  | |
| 54 | 004543000009 SCREW | 2 |  | |
| 55 | 252708000009 SCREW | 1 |  | |
| 56 | 252709000009 LINK | 1 |  << >> | |

| NO. | PARTS NO. | QTY. | 360° IMAGE | INTO MYLIST |
|-----|-------------------------------|------|---|-------------|
| 57 | 240023000009 FELT | 1 | | |
| 58 | 210766000009 PIN | 1 |  | |
| 59 | 252727000009 SPACER | 1 |  | |
| 60 | 204115000009 WASHER | 1 |  | |
| 61 | 007314000009 SCREW | 1 |  | |
| 62 | 252731-91009 FEED BAR ASSY | 1 | | |
| 63 | 007020000009 SCREW | 1 |  | |
| 64 | 252695000009 GUIDE | 1 |  | |
| 65 | 004527000009 BOLT | 2 |  | |
| 66 | 252729-91009 GUIDE ASSY | 1 |  | |
| 67 | 007143000009 SCREW | 2 |  | |

● W200P

差動送り歯
Diff. feed dog









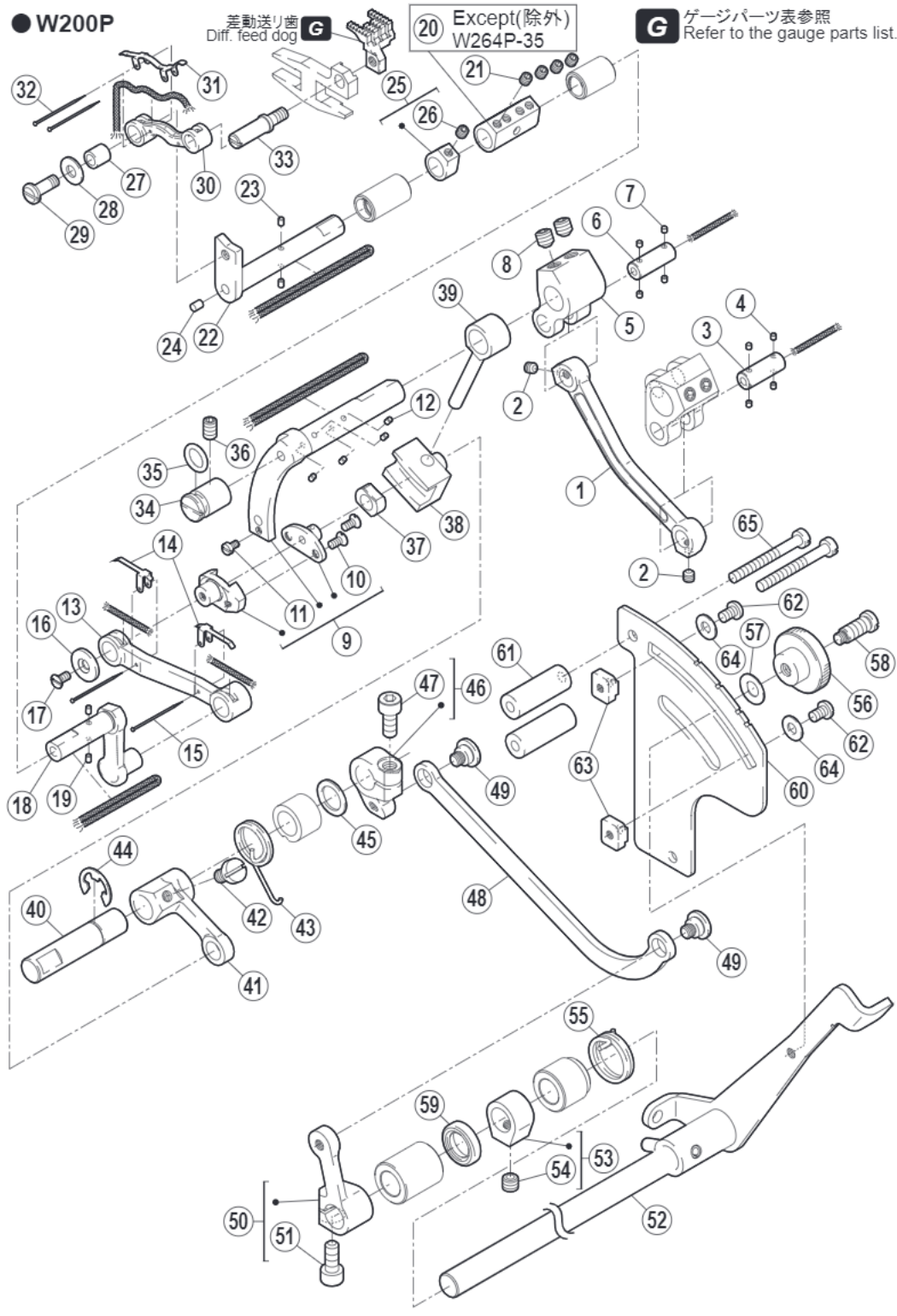













20 Except(除外)
W264P-35















ゲージパーツ表参照
Refer to the gauge parts list.











| NO. | PARTS NO. | QTY. | 360° IMAGE | INTO MYLIST |
|-----|----------------------------|------|---|-------------|
| 1 | 252681000009 LINK | 1 |  | |
| 2 | 004543000009 SCREW | 2 |  | |
| 3 | 252616000009 SHAFT | 2 |  | |
| 4 | 207925000009 FELT | 4 | | |
| 5 | 252617A00009 CRANK | 1 |  | |
| 6 | 252616000009 SHAFT | 2 |  | |
| 7 | 207925000009 FELT | 4 | | |
| 8 | 007142000009 SCREW | 2 |  | |
| 9 | 252682-91009 CRANKSHAFT | 1 |  | |
| 10 | 007041000009 SCREW | 2 |  | |
| 11 | 007031000009 SCREW | 1 | | |
| 12 | 207358000009 FELT | 4 | | |
| 13 | 252687000009 LINK | 1 |  | |
| 14 | 252726000009 LATCH | 2 |  | |

| NO. | PARTS NO. | QTY. | 360° IMAGE | INTO MYLIST |
|-----|----------------------------|------|---|-------------|
| 15 | 210766000009 PIN | 2 |  | |
| 16 | 240055000009 WASHER | 1 |  | |
| 17 | 007041000009 SCREW | 1 |  | |
| 18 | 252688000009 CRANKSHAFT | 1 |  | |
| 19 | 207358000009 FELT | 2 | | |
| 20 | 252716000009 JOINT | 1 |  | |
| 21 | 004543000009 SCREW | 4 |  | |
| 22 | 252710000009 CRANKSHAFT | 1 |  | |
| 23 | 207358000009 FELT | 2 | | |
| 24 | 206748000009 FELT | 1 | | |
| 25 | 240549-92009 COLLAR | 1 |  | |
| 26 | 004543000009 SCREW | 1 |  | |
| 27 | 252725000009 SPACER | 1 |  | |
| 28 | 204115000009 WASHER | 1 |  | |









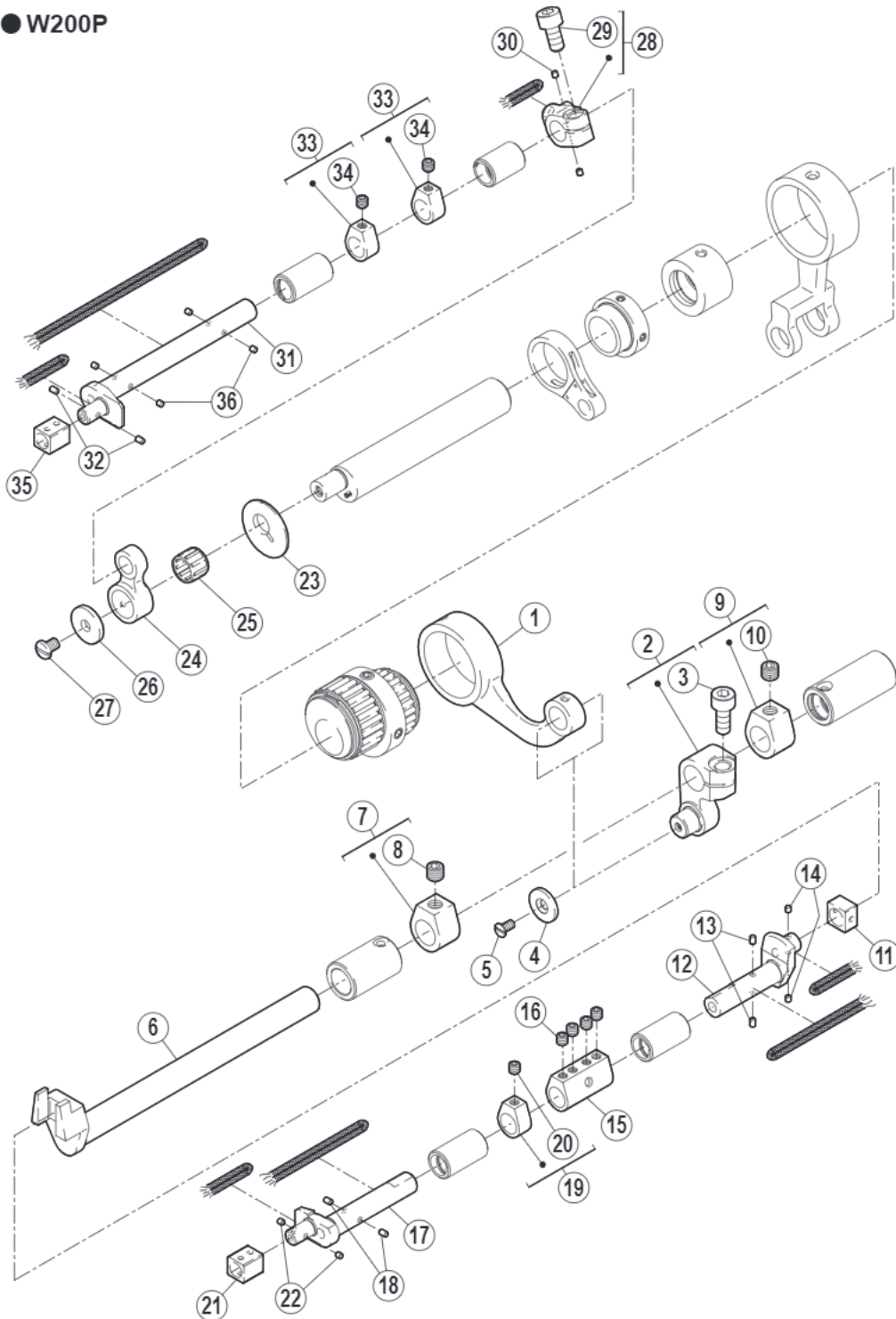

| NO. | PARTS NO. | QTY. | 360° IMAGE | INTO MYLIST |
|-----|------------------------------|------|---|-------------|
| 29 | 007315000009 SCREW | 1 |  | |
| 30 | 252711000009 LINK | 1 |  | |
| 31 | 252720000009 LATCH | 1 |  | |
| 32 | 210766000009 PIN | 2 |  | |
| 33 | 252712000009 SCREW | 1 |  | |
| 34 | 252699000009 GUIDE | 1 |  | |
| 35 | 240129000009 O RING | 1 |  | |
| 36 | 004540000009 SCREW | 1 |  | |
| 37 | 252641000009 BLOCK | 1 |  | |
| 38 | 252686000009 GUIDE | 1 |  | |
| 39 | 252685000009 FEED BAR PIN | 1 |  | |
| 40 | 252691000009 SHAFT | 1 |  | |
| 41 | 252693000009 LEVER | 1 |  | |
| 42 | 007027000009 SCREW | 1 |  | |













| NO. | PARTS NO. | QTY. | 360° IMAGE | INTO MYLIST |
|-----|--------------------------------|------|---|-------------|
| 43 | 252692000019 SPRING | 1 | | |
| 44 | 202577000009 RETAINING RING | 1 |  | |
| 45 | 240102000009 WASHER | 1 |  | |
| 46 | 212035B92009 CRANK | 1 |  | |
| 47 | 004531000009 BOLT | 1 |  | |
| 48 | 252690000009 LINK | 1 |  | |
| 49 | 007058000009 SCREW | 2 |  | |
| 50 | 252689-92009 CRANK | 1 |  | |
| 51 | 004531000009 BOLT | 1 |  | |
| 52 | 252721-91009 LEVER ASSY | 1 |  | |
| 53 | 240235-92009 COLLAR | 1 |  | |
| 54 | 004547000009 SCREW | 1 | | |
| 55 | 252657000009 SPRING | 1 |  | |
| 56 | 252069A00009 NUT | 1 |  | |





| NO. | PARTS NO. | QTY. | 360° IMAGE | INTO MYLIST |
|-----|-------------------------------|------|---|-------------|
| 57 | 211301000009 SPRING WASHER | 1 |  | |
| 58 | 007059000009 SCREW | 1 |  | |
| 59 | 240063000009 OIL SEAL | 1 |  | |
| 60 | 252730000009 GUIDE PLATE | 1 |  | |
| 61 | 252719000009 SPACER | 2 |  | |
| 62 | 007018A00009 SCREW | 2 | | |
| 63 | 252658000009 STOPPER | 2 |  | |
| 64 | 201185000009 WASHER | 2 |  | |
| 65 | 007072000009 SCREW | 2 |  | |

● W200P



| NO. | PARTS NO. | QTY. | 360° IMAGE | INTO MYLIST |
|-----|----------------------------|------|---|-------------|
| 1 | 252608000009 CONNECTION | 1 |  | |
| 2 | 252609-92009 CRANK | 1 |  | |
| 3 | 004531000009 BOLT | 1 |  | |
| 4 | 240055000009 WASHER | 1 |  | |
| 5 | 007041000009 SCREW | 1 |  | |
| 6 | 252610D00009 CRANKSHAFT | 1 |  | |
| 7 | 240235-92009 COLLAR | 1 |  | |
| 8 | 004547000009 SCREW | 1 | | |
| 9 | 240235-92009 COLLAR | 1 |  | |
| 10 | 004547000009 SCREW | 1 | | |
| 11 | 252697000009 BLOCK | 1 |  | |
| 12 | 252698000009 CRANKSHAFT | 1 |  | |
| 13 | 207358000009 FELT | 2 | | |
| 14 | 207925000009 FELT | 2 | « » | |

| NO. | PARTS NO. | QTY. | 360° IMAGE | INTO MYLIST |
|-----|--------------------------------|------|---|-------------|
| 15 | 252716000009 JOINT | 1 |  | |
| 16 | 004543000009 SCREW | 4 |  | |
| 17 | 252713000009 CRANKSHAFT | 1 |  | |
| 18 | 207358000009 FELT | 2 | | |
| 19 | 240549-92009 COLLAR | 1 |  | |
| 20 | 004543000009 SCREW | 1 |  | |
| 21 | 252715000009 BLOCK | 1 |  | |
| 22 | 207925000009 FELT | 2 | | |
| 23 | 252700000009 WASHER | 1 |  | |
| 24 | 252703000009 CONNECTION | 1 |  | |
| 25 | 240544-20009 NEEDLE BEARING | 1 |  | |
| 26 | 204107000009 WASHER | 1 |  | |
| 27 | 007143000009 SCREW | 1 |  | |
| 28 | 252694-92009 CRANK | 1 |   | |

| NO. | PARTS NO. | QTY. | 360° IMAGE | INTO MYLIST |
|-----|----------------------------|------|---|-------------|
| 29 | 004500000009 BOLT | 1 |  | |
| 30 | 207925000009 FELT | 2 | | |
| 31 | 252714000009 CRANKSHAFT | 1 |  | |
| 32 | 207925000009 FELT | 2 | | |
| 33 | 240549-92009 COLLAR | 2 |  | |
| 34 | 004543000009 SCREW | 2 |  | |
| 35 | 252715000009 BLOCK | 1 |  | |
| 36 | 207358000009 FELT | 4 | | |

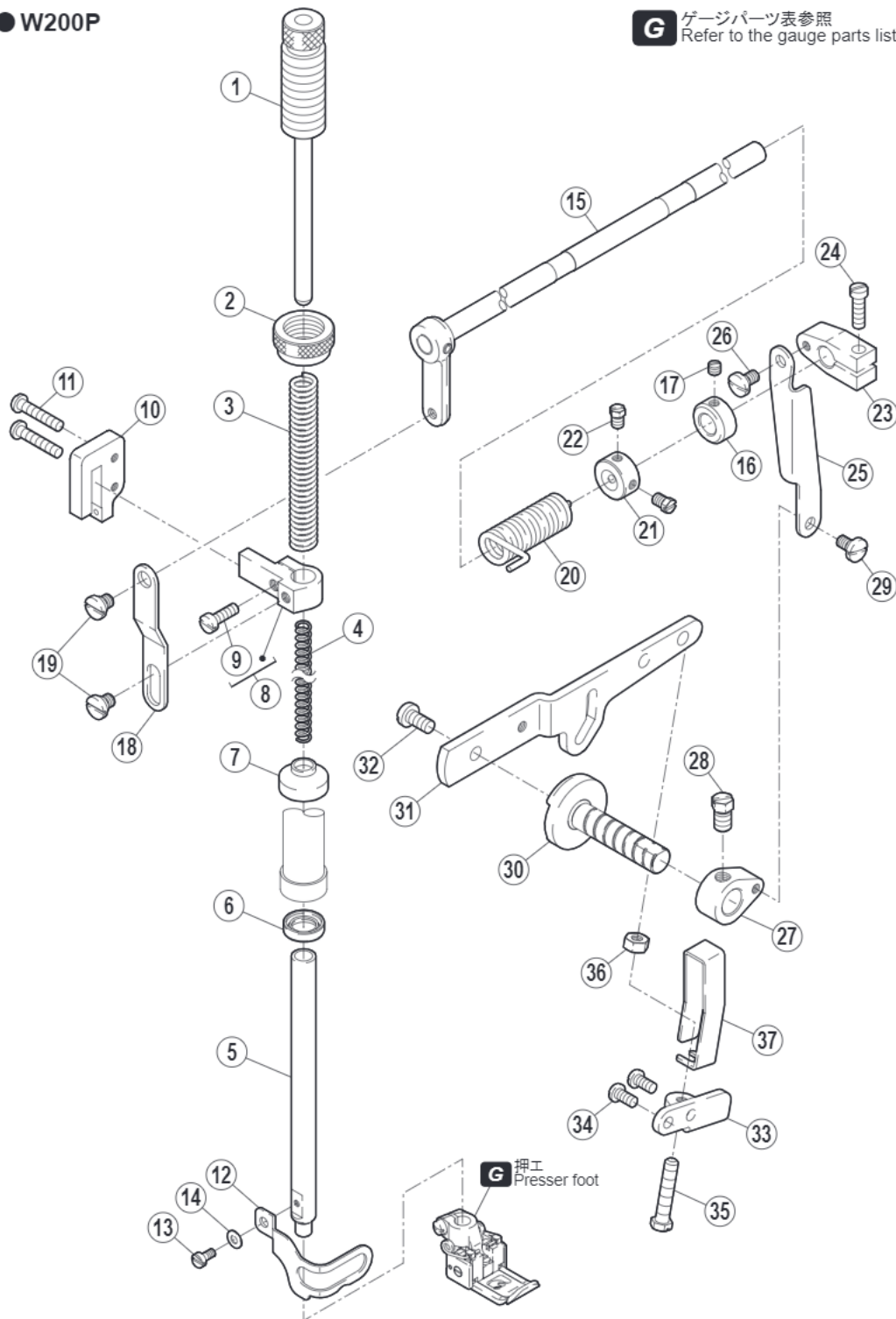

● W200P

G ゲージパーツ表参照
Refer to the gauge parts list.



| NO. | PARTS NO. | QTY. | 360° IMAGE | INTO MYLIST |
|-----|--|------|---|-------------|
| 1 | 253000-91009 ADJUSTING BAR | 1 |  | |
| 2 | 253003000019 NUT | 1 |  | |
| 3 | 240252000009 SPRING | 1 |  | |
| 4 | 240253000009 SPRING | 1 |  | |
| 5 | 253026000019 PRESSER BAR | 1 |  | |
| 6 | 240585000009 OIL SEAL | 1 |  | |
| 7 | 253053000009 OIL SHIELD | 1 |  | |
| 8 | 263007-92009 PRESSER BAR CLAMP ASSY | 1 |  | |
| 9 | 007021000009 SCREW | 1 |  | |
| 10 | 253005091019 GUIDE ASSY | 1 |  | |
| 11 | 007025A00009 SCREW | 2 |  | |
| 12 | 6G0084000009 FINGER GUARD | 1 |  | |
| 13 | 007010000009 SCREW | 1 |  | |
| 14 | 240474000009 WASHER | 1 |  | |









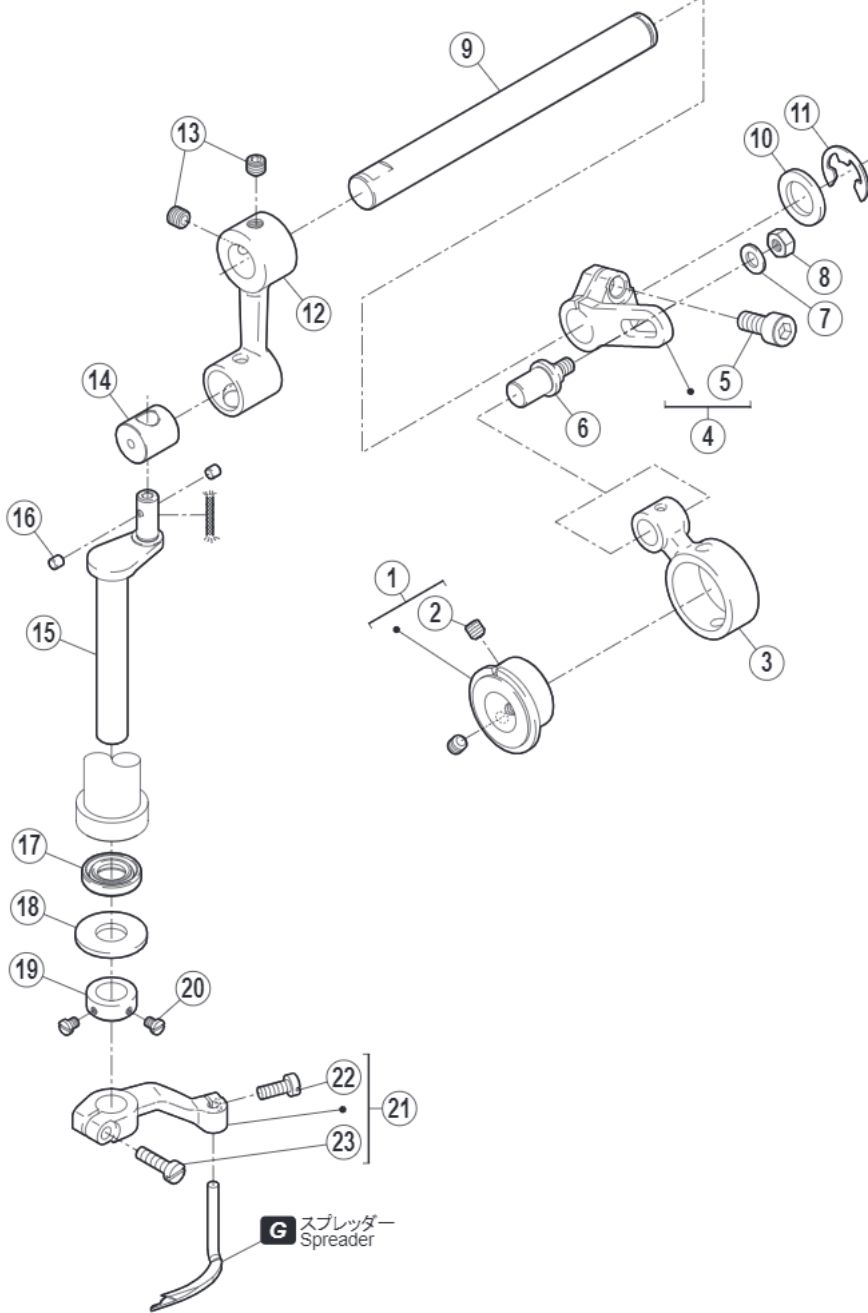

| NO. | PARTS NO. | QTY. | 360° IMAGE | INTO MYLIST |
|-----|----------------------------|------|---|-------------|
| 15 | 253008A91009 LEVER ASSY | 1 |  | |
| 16 | 192024000009 COLLAR | 1 |  | |
| 17 | 0W00024-1009 SCREW | 1 | | |
| 18 | 206157000009 LINK | 1 |  | |
| 19 | 1B0034000019 SCREW | 2 |  | |
| 20 | 253010000009 SPRING | 1 |  | |
| 21 | 206156000009 COLLAR | 1 |  | |
| 22 | 005084000009 BOLT | 2 |  | |
| 23 | 206149000009 CRANK | 1 |  | |
| 24 | 005187000009 SCREW | 1 |  | |
| 25 | 253027000009 LINK | 1 |  | |
| 26 | 005184000009 SCREW | 1 |  | |
| 27 | 206148000009 CRANK | 1 |  | |
| 28 | 002022-40009 BOLT | 1 |  | |





| NO. | PARTS NO. | QTY. | 360° IMAGE | INTO MYLIST |
|-----|---------------------------------------|------|---|-------------|
| 29 | 005184000009 SCREW | 1 |  | |
| 30 | 253013000009 SHAFT | 1 |  | |
| 31 | 253014000009 LEVER | 1 |  | |
| 32 | 007034000009 SCREW | 1 |  | |
| 33 | 253015000019 BRACKET | 1 |  | |
| 34 | 007019A00009 SCREW | 2 | | |
| 35 | 004581000009 BOLT | 1 |  | |
| 36 | 004805000009 NUT | 1 |  | |
| 37 | 250230-RA009 FOOT LIFT LEVER GUARD | 1 |  | |

● W200P

G ゲージパーツ表参照
Refer to the gauge parts list.









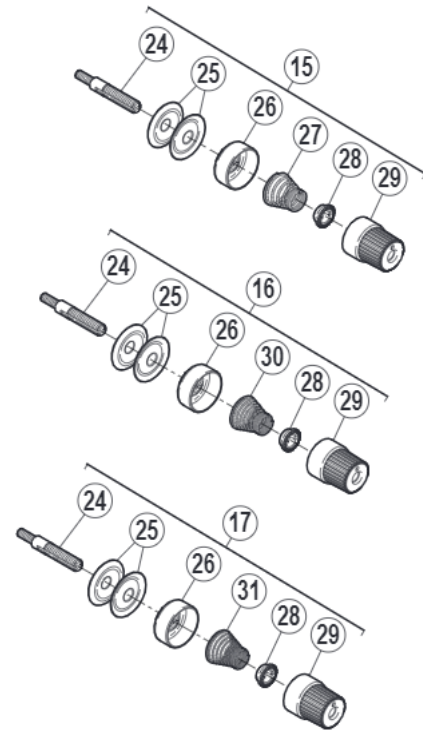
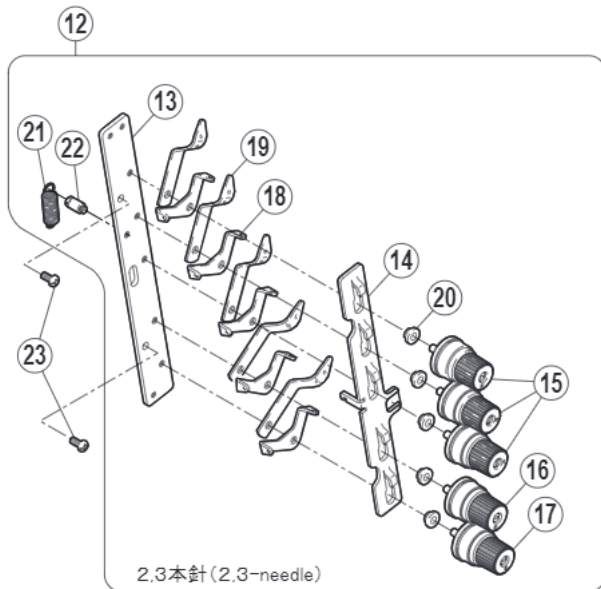
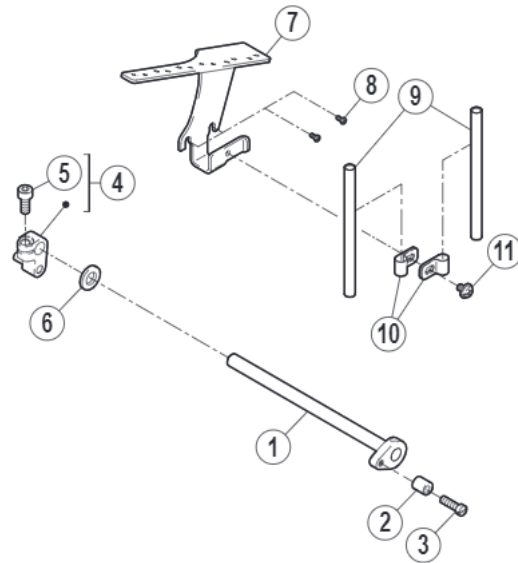

















| NO. | PARTS NO. | QTY. | 360° IMAGE | INTO MYLIST |
|-----|--------------------------------|------|---|-------------|
| 1 | 254501A92009 ECCENTRIC | 1 |  | |
| 2 | 004514000009 SCREW | 2 |  | |
| 3 | 254511000009 CONNECTION | 1 |  | |
| 4 | 254503-92009 CRANK | 1 |  | |
| 5 | 004534000009 BOLT | 1 |  | |
| 6 | 254504000009 SCREW | 1 |  | |
| 7 | 240062000009 WASHER | 1 | | |
| 8 | 004805000009 NUT | 1 |  | |
| 9 | 254519000009 SHAFT | 1 |  | |
| 10 | 206180000009 WASHER | 1 | | |
| 11 | 306671000009 RETAINING RING | 1 |  | |
| 12 | 254506B00009 CRANK | 1 |  | |
| 13 | 004547000009 SCREW | 2 | | |
| 14 | 254507000009 BLOCK | 1 |  | |



| NO. | PARTS NO. | QTY. | 360° IMAGE | INTO MYLIST |
|-----|----------------------------|------|---|-------------|
| 15 | 254518000009 CRANKSHAFT | 1 |  | |
| 16 | 207925000009 FELT | 2 | | |
| 17 | 210586000009 OIL SEAL | 1 |  | |
| 18 | 240584000009 WASHER | 1 |  | |
| 19 | 212039000009 COLLAR | 1 |  | |
| 20 | 001227000009 SCREW | 2 | | |
| 21 | 254516-92009 LEVER | 1 |  | |
| 22 | 007020000009 SCREW | 1 |  | |
| 23 | 007022000009 SCREW | 1 |  | |

● W200P











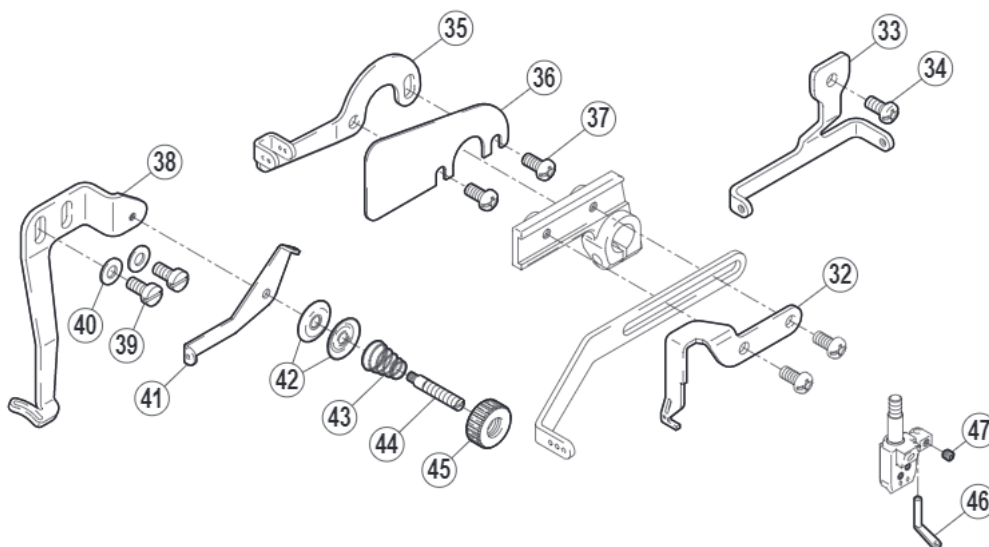
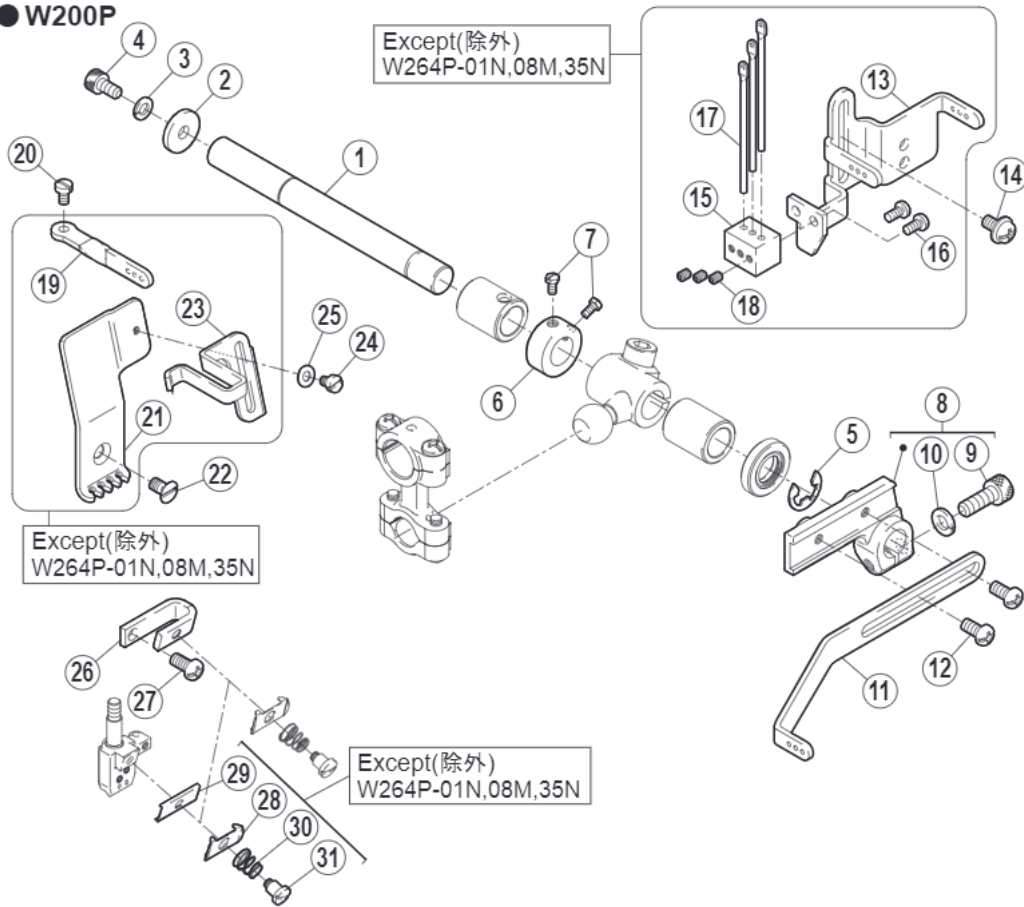



| NO. | PARTS NO. | QTY. | 360° IMAGE | INTO MYLIST |
|-----|-------------------------------------|------|---|-------------|
| 1 | 254000-91009 LEVER | 1 | | |
| 2 | 254022000019 SPACER | 1 |  | |
| 3 | 005187000009 SCREW | 1 |  | |
| 4 | 254003B91009 CRANK | 1 |  | |
| 5 | 004531000009 BOLT | 1 |  | |
| 6 | 202868000009 WASHER | 1 |  | |
| 7 | 254008000009 THREAD GUIDE | 1 |  | |
| 8 | 007019A00009 SCREW | 2 | | |
| 9 | 192120000009 PIPE | 2 |  | |
| 10 | 206115000009 BRACKET | 2 |  | |
| 11 | 1B00710HZ009 SCREW | 1 |  | |
| 12 | 263541-9T009 TENSION SPRING ASSY | 1 | | |
| 13 | 254019000009 BRACKET | 1 |  | |
| 14 | 254021000009 THREAD RELEASER | 1 |  | |













| NO. | PARTS NO. | QTY. | 360° IMAGE | INTO MYLIST |
|-----|--|------|---|-------------|
| 15 | 263542A9T009 TENSION SPRING ASSY (HEAVY) | 3 |  | |
| 16 | 263542B9T009 TENSION SPRING ASSY (MEDIUM) | 1 |  | |
| 17 | 263542C9T009 TENSION SPRING ASSY (LIGHT) | 1 |  | |
| 18 | 254020000009 THREAD GUIDE | 5 |  | |
| 19 | 206203000009 THREAD GUIDE | 5 |  | |
| 20 | 206202000009 SPACER | 5 |  | |
| 21 | 306301000009 SPRING | 1 |  | |
| 22 | 005447000009 SCREW | 1 |  | |
| 23 | 007019A00009 SCREW | 2 | | |
| 24 | 001817-2A009 SCREW STUD | 1 |  | |
| 25 | 210319000009 TENSION DISC | 2 |  | |
| 26 | 263544-TA009 SPRING SHIELD | 1 |  | |
| 27 | 201037000009 SPRING (HEAVY) | 1 |  | |
| 28 | 208448000009 RATCHET | 1 |  | |

| NO. | PARTS NO. | QTY. | 360° IMAGE | INTO MYLIST |
|-----|---------------------------------|------|---|-------------|
| 29 | 263543-TA009 KNOB | 1 |  | |
| 30 | 201086000009 SPRING (MEDIUM) | 1 |  | |
| 31 | 201068000009 SPRING (LIGHT) | 1 |  | |





● W200P



| NO. | PARTS NO. | QTY. | 360° IMAGE | INTO MYLIST |
|-----|--------------------------------|------|---|-------------|
| 1 | 253503000009 SHAFT | 1 |  | |
| 2 | 204107000009 WASHER | 1 |  | |
| 3 | 201252000009 SPRING WASHER | 1 | | |
| 4 | 004527000009 BOLT | 1 |  | |
| 5 | 205061000009 RETAINING RING | 1 |  | |
| 6 | 204754A00009 COLLAR | 1 |  | |
| 7 | 002193000009 BOLT | 2 |  | |
| 8 | 253504-92009 LEVER | 1 |  | |
| 9 | 004501000009 BOLT | 1 |  | |
| 10 | 303067000009 SPRING WASHER | 1 |  | |
| 11 | 253505A00019 THREAD TAKE-UP | 1 |  | |
| 12 | 007019A00009 SCREW | 2 | | |
| 13 | 253544000009 THREAD GUIDE | 1 |  | |
| 14 | 1B00720HZ009 SCREW | 1 |  | |

| NO. | PARTS NO. | QTY. | 360° IMAGE | INTO MYLIST |
|-----|--------------------------------------|------|---|-------------|
| 15 | 253545000009 HOLDER | 1 |  | |
| 16 | 007010000009 SCREW | 2 |  | |
| 17 | 1K5003000009 THREAD GUIDE | 3 |  | |
| 18 | 004535000009 SCREW | 3 |  | |
| 19 | 253507000009 THREAD GUIDE | 1 |  | |
| 20 | 007009000009 SCREW | 1 |  | |
| 21 | 253508A00009 THREAD GUIDE | 1 |  | |
| 22 | 007077000009 SCREW | 1 |  | |
| 23 | 253509A00009 THREAD SUPPORT | 1 |  | |
| 24 | 007008000009 SCREW | 1 | | |
| 25 | 240474000009 WASHER | 1 |  | |
| 26 | 253516000009 THREAD TENSION GUIDE | 1 |  | |
| 27 | 007019A00009 SCREW | 1 | | |
| 28 | 253593000009 THREAD RETAINER | 1 |  | |







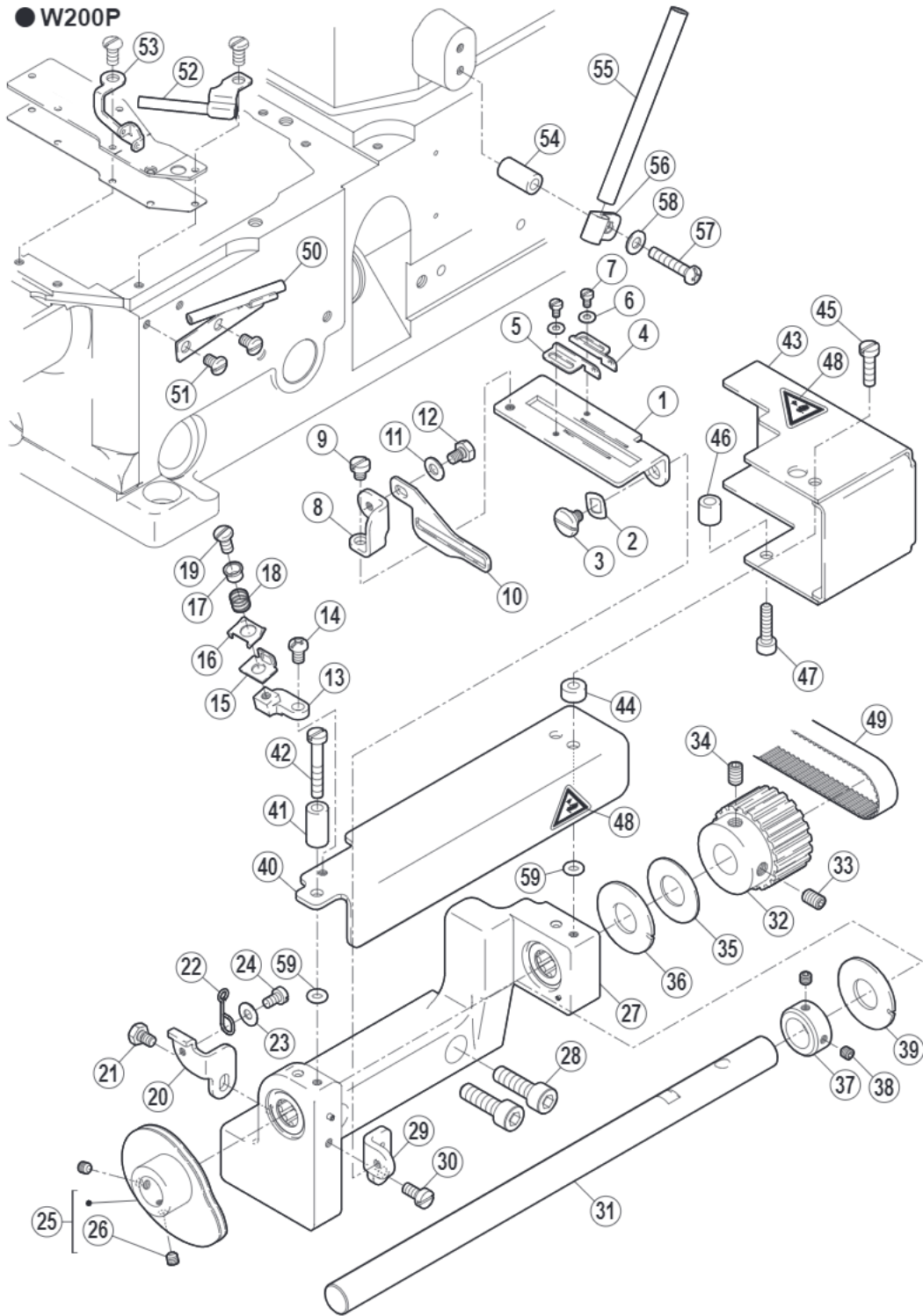





| NO. | PARTS NO. | QTY. | 360° IMAGE | INTO MYLIST |
|-----|---------------------------------|----------|---|-------------|
| 29 | 234561000009 THREAD GUIDE | 1 |  | |
| 30 | 253517000009 SPRING | 1 |  | |
| 31 | 0W09070-2009 SCREW | 1 |  | |
| 32 | 253506000009 THREAD TAKE-UP | 1 |  | |
| 33 | 253515000009 THREAD GUIDE | 1 |  | |
| 34 | 007019A00009 SCREW | 1 | | |
| 35 | 253514000009 THREAD GUIDE | 1 |  | |
| 36 | 250229000009 SAFETY COVER | 1 |  | |
| 37 | 007019A00009 SCREW | 2 | | |
| 38 | 253548B00009 THREAD GUIDE | 1 |  | |
| 39 | 007019000009 SCREW | 2 |  | |
| 40 | 303448000009 WASHER | 2 |  | |
| 41 | 253547000009 THREAD GUIDE | 1 |  | |
| 42 | 137108000009 THREAD RETAINER | 2<<< >>> |  | |





| NO. | PARTS NO. | QTY. | 360° IMAGE | INTO MYLIST |
|-----|------------------------------|------|---|-------------|
| 43 | 211388000009 SPRING | 1 |  | |
| 44 | 007167000019 SCREW | 1 |  | |
| 45 | 275034000009 KNOB | 1 |  | |
| 46 | 253511000009 THREAD GUIDE | 1 |  | |
| 47 | 004554000009 SCREW | 1 | | |









● W200P





| NO. | PARTS NO. | QTY. | 360° IMAGE | INTO MYLIST |
|-----|--------------------------------------|------|---|-------------|
| 1 | 253681000009 BRACKET | 1 |  | |
| 2 | 210307000009 WASHER | 1 |  | |
| 3 | 007066000009 SCREW | 1 | | |
| 4 | 253534A00009 THREAD GUIDE | 1 |  | |
| 5 | 253533D00009 THREAD GUIDE | 1 |  | |
| 6 | 210585000009 WASHER | 2 |  | |
| 7 | 007031000009 SCREW | 2 | | |
| 8 | 253632000009 BRACKET | 1 |  | |
| 9 | 007196000009 SCREW | 1 |  | |
| 10 | 253680000009 THREAD GUIDE | 1 |  | |
| 11 | 303448000009 WASHER | 1 |  | |
| 12 | 004325000009 BOLT | 1 |  | |
| 13 | 253676000009 THREAD TENSION GUIDE | 1 |  | |
| 14 | 007018A00009 SCREW | 1 |  | |

| NO. | PARTS NO. | QTY. | 360° IMAGE | INTO MYLIST |
|-----|---------------------------------------|------|---|-------------|
| 15 | 212503000009 THREAD RETAINER GUIDE | 1 |  | |
| 16 | 212504000009 THREAD RETAINER | 1 |  | |
| 17 | 210750000009 GUIDE | 1 |  | |
| 18 | 210751000009 SPRING | 1 |  | |
| 19 | 007082000009 SCREW | 1 |  | |
| 20 | 253635000019 BRACKET | 1 |  | |
| 21 | 004325000009 BOLT | 1 |  | |
| 22 | 210306000009 SPRING | 1 |  | |
| 23 | 137906000009 WASHER | 1 |  | |
| 24 | 007012000009 SCREW | 1 |  | |
| 25 | 253689-91009 THREAD TAKE-UP ASSY | 1 | | |
| 26 | 004543000009 SCREW | 2 |  | |
| 27 | 253625-9P009 BRACKET ASSY | 1 | | |
| 28 | 004503000009 BOLT | 2 |  | |









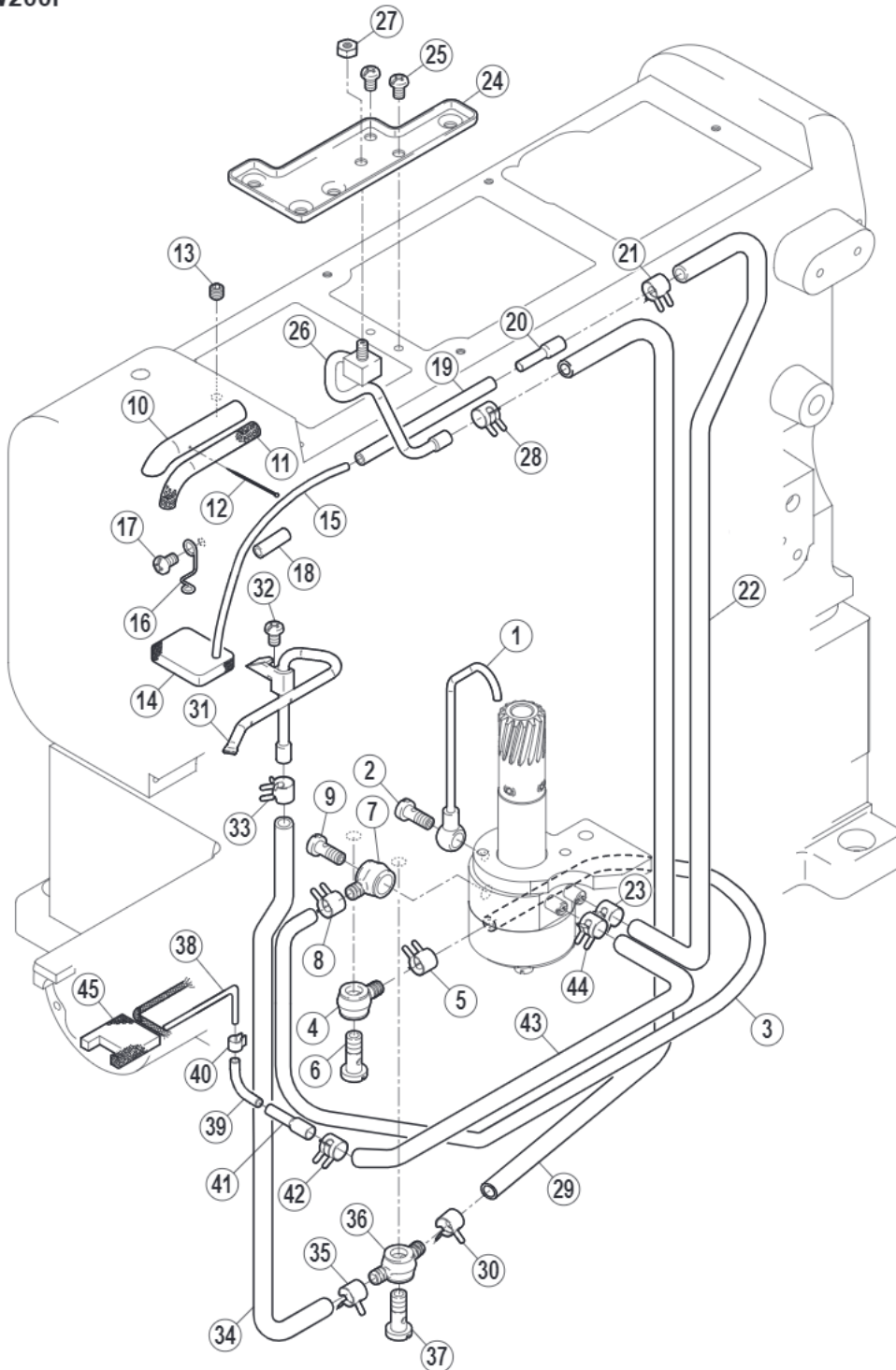

| NO. | PARTS NO. | QTY. | 360° IMAGE | INTO MYLIST |
|-----|-------------------------|------|---|-------------|
| 29 | 253636000009 BRACKET | 1 |  | |
| 30 | 007019000009 SCREW | 1 |  | |
| 31 | 253671000009 SHAFT | 1 |  | |
| 32 | 253623000009 GEAR | 1 |  | |
| 33 | 004548000009 SCREW | 1 |  | |
| 34 | 004555000009 SCREW | 1 |  | |
| 35 | 240279000009 WASHER | 1 |  | |
| 36 | 240278000009 WASHER | 1 |  | |
| 37 | 240308000009 COLLAR | 1 |  | |
| 38 | 004543000009 SCREW | 2 |  | |
| 39 | 240278000009 WASHER | 1 |  | |
| 40 | 253640000019 COVER | 1 |  | |
| 41 | 240332000009 SPACER | 1 |  | |
| 42 | 007026000009 SCREW | 1 |  | |









| NO. | PARTS NO. | QTY. | 360° IMAGE | INTO MYLIST |
|-----|----------------------------------|------|---|-------------|
| 43 | 253674000009 BELT COVER | 1 |  | |
| 44 | 240321000009 SPACER | 1 | | |
| 45 | 007022000009 SCREW | 1 |  | |
| 46 | 240560000009 SPACER | 1 |  | |
| 47 | 004529000009 BOLT | 1 |  | |
| 48 | 9A3046000009 SEAL | 2 | | |
| 49 | 253641A00009 TIMING BELT | 1 |  | |
| 50 | 253685-91009 THREAD TUBE ASSY | 1 |  | |
| 51 | 007143000009 SCREW | 2 |  | |
| 52 | 253687-91009 THREAD TUBE ASSY | 1 |  | |
| 53 | 253675000009 THREAD GUIDE | 1 |  | |
| 54 | 240332000009 SPACER | 1 |  | |
| 55 | 253679000009 PIPE | 1 |  | |
| 56 | 206115000009 BRACKET | 1 |  | |









| NO. | PARTS NO. | QTY. | 360° IMAGE | INTO MYLIST |
|-----|------------------------|------|---|-------------|
| 57 | 007025A00009 SCREW | 1 |  | |
| 58 | 303448000009 WASHER | 1 |  | |
| 59 | 206366000009 O RING | 2 |  | |

● W200P



| NO. | PARTS NO. | QTY. | 360° IMAGE | INTO MYLIST |
|-----|-----------------------------|------|---|-------------|
| 1 | 255035-91009 PIPE | 1 |  | |
| 2 | 255037000009 JOINT SCREW | 1 |  | |
| 3 | 240135000009 TUBE | 1 | | |
| 4 | 200136000009 JOINT | 1 | | |
| 5 | 202199000009 CLAMP | 1 |  | |
| 6 | 200152000009 JOINT | 1 |  | |
| 7 | 200136000009 JOINT | 1 | | |
| 8 | 202199000009 CLAMP | 1 |  | |
| 9 | 200152000009 JOINT | 1 |  | |
| 10 | 255003A00009 PIPE | 1 |  | |
| 11 | 240136000009 FELT | 1 | | |
| 12 | 210766000009 PIN | 1 |  | |
| 13 | 004514000009 SCREW | 1 |  | |
| 14 | 255021000009 FELT | 1 |  « » | |









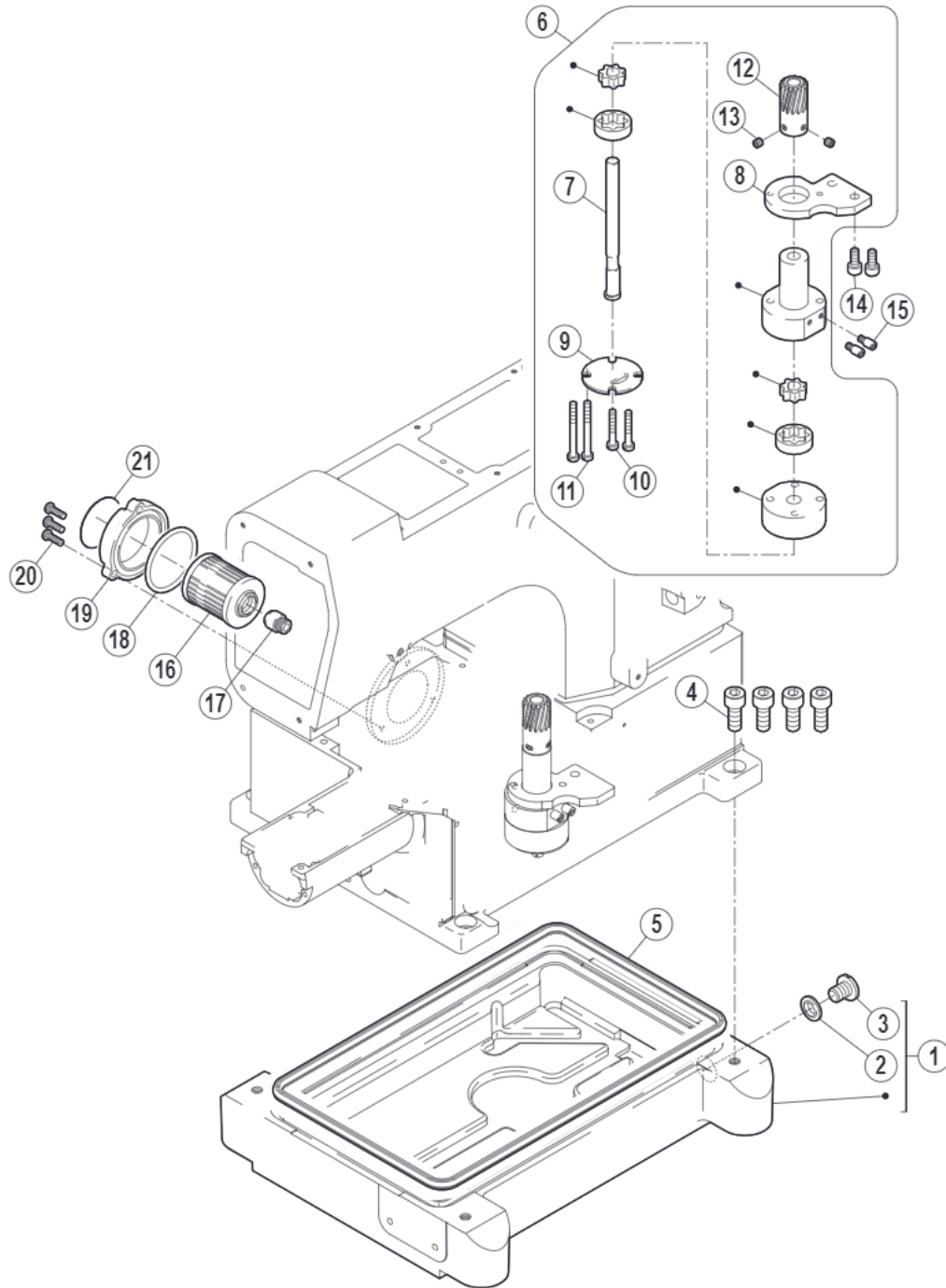

| NO. | PARTS NO. | QTY. | 360° IMAGE | INTO MYLIST |
|-----|-----------------------------------|------|---|-------------|
| 15 | 255039000009 PIPE | 1 |  | |
| 16 | 255005000009 LATCH | 1 |  | |
| 17 | 007018A00009 SCREW | 1 | | |
| 18 | 240143000009 TUBE | 1 | | |
| 19 | 240568000009 TUBE | 1 | | |
| 20 | 255038000009 JOINT | 1 |  | |
| 21 | 202199000009 CLAMP | 1 |  | |
| 22 | 240145000009 TUBE | 1 | | |
| 23 | 202199000009 CLAMP | 1 |  | |
| 24 | 255099000009 OIL RELEASE PLATE | 1 |  | |
| 25 | 007018A00009 SCREW | 2 | | |
| 26 | 255097-91009 OIL SPLASH PIPE | 1 |  | |
| 27 | 004821000009 NUT | 1 |  | |
| 28 | 202199000009 CLAMP | 1 |  | |





| NO. | PARTS NO. | QTY. | 360° IMAGE | INTO MYLIST |
|-----|---------------------------------|------|---|-------------|
| 29 | 240006000009 TUBE | 1 | | |
| 30 | 202199000009 CLAMP | 1 |  | |
| 31 | 255094-91009 OIL SPLASH PIPE | 1 |  | |
| 32 | 007018A00009 SCREW | 1 | | |
| 33 | 202199000009 CLAMP | 1 |  | |
| 34 | 200140A00009 TUBE | 1 | | |
| 35 | 202199000009 CLAMP | 1 |  | |
| 36 | 255123000009 JOINT | 1 | | |
| 37 | 200152000009 JOINT | 1 |  | |
| 38 | 255139000009 PIPE | 1 |  | |
| 39 | 240144000009 TUBE | 1 | | |
| 40 | 255137000009 CLAMP | 1 |  | |
| 41 | 255038000009 JOINT | 1 |  | |
| 42 | 202199000009 CLAMP | 1 |  << >> | |

| NO. | PARTS NO. | QTY. | 360° IMAGE | INTO MYLIST |
|-----|-----------------------|------|---|-------------|
| 43 | 205763000009 TUBE | 1 | | |
| 44 | 202199000009 CLAMP | 1 |  | |
| 45 | 255140000009 FELT | 1 | | |

● W200P



| NO. | PARTS NO. | QTY. | 360° IMAGE | INTO MYLIST |
|-----|-------------------------------|------|---|-------------|
| 1 | 255041000009 OIL RESERVOIR | 1 | | |
| 2 | 202287A000009 WASHER | 1 |  | |
| 3 | 005138B000009 SCREW | 1 |  | |
| 4 | 0045040000009 BOLT | 4 |  | |
| 5 | 1L30040000009 RUBBER RING | 1 |  | |
| 6 | 255091-91009 PUMP | 1 |  | |
| 7 | 2550240000009 SHAFT | 1 |  | |
| 8 | 2550330000009 BRACKET | 1 | | |
| 9 | 2550280000009 COVER | 1 |  | |
| 10 | 0070260000009 SCREW | 2 |  | |
| 11 | 0071050000009 SCREW | 2 |  | |
| 12 | 2550190000009 WORM WHEEL | 1 | | |
| 13 | 0045140000009 SCREW | 2 |  | |
| 14 | 0045310000009 BOLT | 2 |  | |





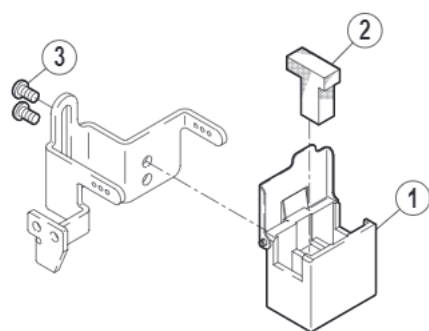



| NO. | PARTS NO. | QTY. | 360° IMAGE | INTO MYLIST |
|-----|--------------------------------|------|---|-------------|
| 15 | 255093000009 JOINT SCREW | 2 |  | |
| 16 | 206233000009 FILTER ELEMENT | 1 |  | |
| 17 | 210200000009 FILTER BRACKET | 1 |  | |
| 18 | 206431000009 O RING | 1 |  | |
| 19 | 210201-PD019 COVER | 1 |  | |
| 20 | 007021A00009 SCREW | 3 | | |
| 21 | 9A3002000009 SEAL | 1 | | |

● W200P



| NO. | PARTS NO. | QTY. | 360° IMAGE | INTO MYLIST |
|-----|---|------|---------------|-------------|
| 1 | 207065A91009 SILICONE OIL RESERVOIR ASSY | 1 | | |
| 2 | 207068000009 FELT | 1 | | |
| 3 | 004928000009 TAPPING SCREW | 2 | | |









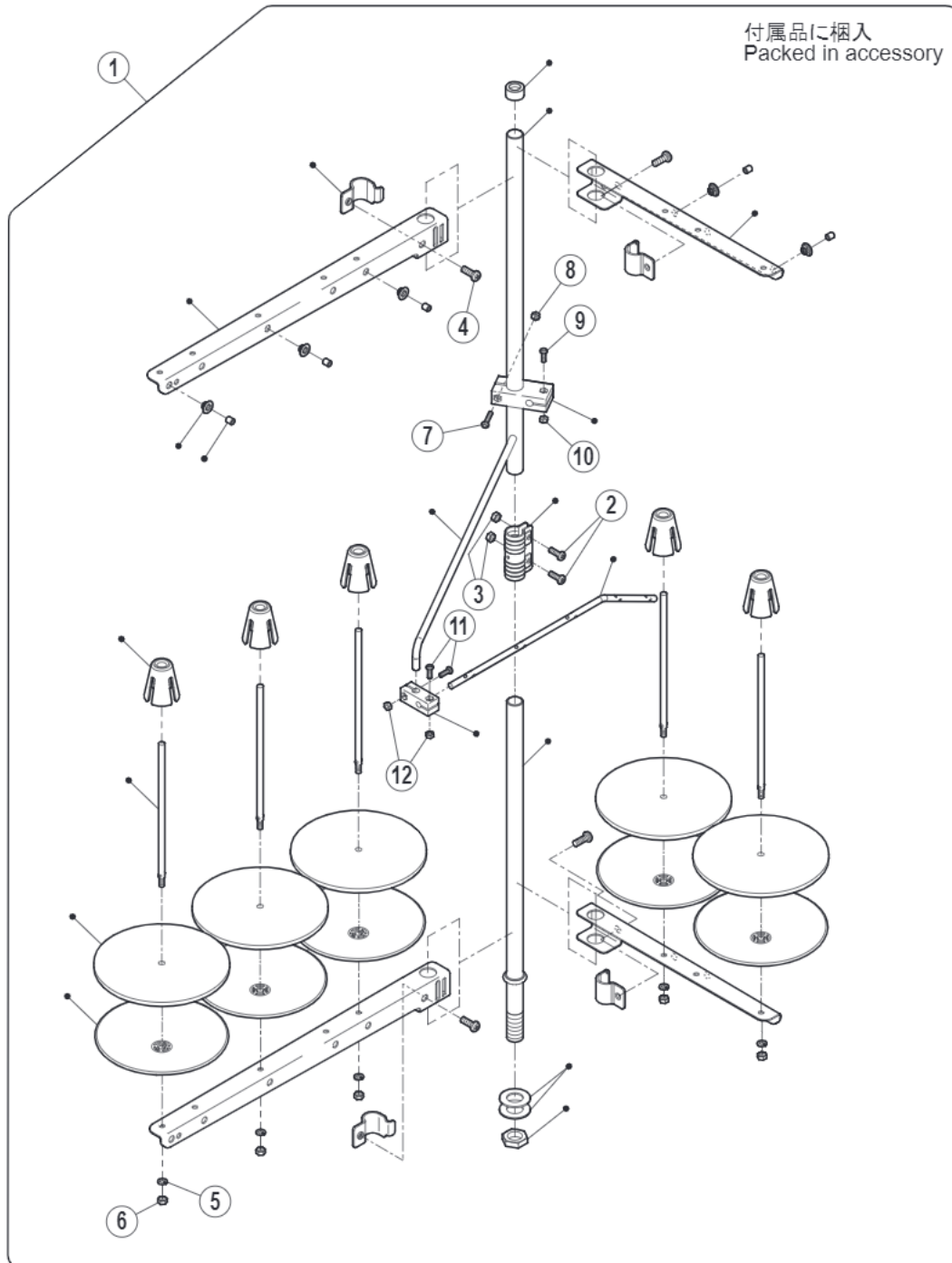

<< >>

| NO. | PARTS NO. | QTY. | 360° IMAGE | INTO MYLIST |
|-----|--|------|--|-------------|
| 1 | 259002000009 SEMI-SUBMERGED INSTALLATION ASSY | 1 | | |
| 2 | 009016000009 RUBBER CUSHION (SET) | 1 | | |
| 3 | 206338000009 RUBBER CUSHION | 4 |  | |
| 4 | 206336000009 NUT | 4 |  | |
| 5 | 259000000009 REST BOARD | 2 | | |
| 6 | 004512000009 BOLT | 4 |  | |
| 7 | 206337000009 WASHER | 12 |  | |
| 8 | 205764000009 RUBBER CUSHION | 4 |  | |
| 9 | 205765000009 LINER | 4 |  | |
| 10 | 007093000009 SCREW | 4 |  | |
| 11 | 206329000009 TREADLE CHAIN GUIDE | 1 |  | |
| 12 | 007027000009 SCREW | 2 |  | |
| 13 | 205467000009 SPACER | 4 |  | |
| 14 | 009016000009 RUBBER CUSHION (SET) | 1 |  | |

| NO. | PARTS NO. | QTY. | 360° IMAGE | INTO MYLIST |
|-----|--------------------------------|------|--|-------------|
| 15 | 206338000009 RUBBER CUSHION | 4 |  | |
| 16 | 009032000009 SCREW (SET) | 1 |  | |
| 17 | 207073000009 FIXING ROD | 4 |  | |
| 18 | 207074000009 RETAINING RING | 4 |  | |
| 19 | 200728000009 WASHER | 4 |  | |
| 20 | 202045000009 SPRING WASHER | 4 |  | |
| 21 | 005020000009 NUT | 4 |  | |
| 22 | 259003ATB009 BELT GUARD | 1 |  | |
| 23 | 004906000009 SCREW | 3 |  | |
| 24 | 303335000009 WASHER | 3 |  | |
| 25 | 000138000009 GREASE | 1 | | |

● W200P



| NO. | PARTS NO. | QTY. | 360° IMAGE | INTO MYLIST |
|-----|---|------|---|-------------|
| 1 | 9E0026A9Q009 5-THREAD STAND COMPLETE | 1 | | |
| 2 | 004066-HU009 SCREW | 2 |  | |
| 3 | 004067-HU009 NUT | 2 |  | |
| 4 | 004068-HU009 SCREW | 4 |  | |
| 5 | 303067A000009 SPRING WASHER | 5 |  | |
| 6 | 004067-HU009 NUT | 5 |  | |
| 7 | 0041130000009 SCREW | 1 |  | |
| 8 | 0048030000009 NUT | 1 |  | |
| 9 | 004065-HU009 SCREW | 1 |  | |
| 10 | 0048030000009 NUT | 1 |  | |
| 11 | 004065-HU009 SCREW | 2 |  | |
| 12 | 0048030000009 NUT | 2 |  | |

●W200HP-01GB

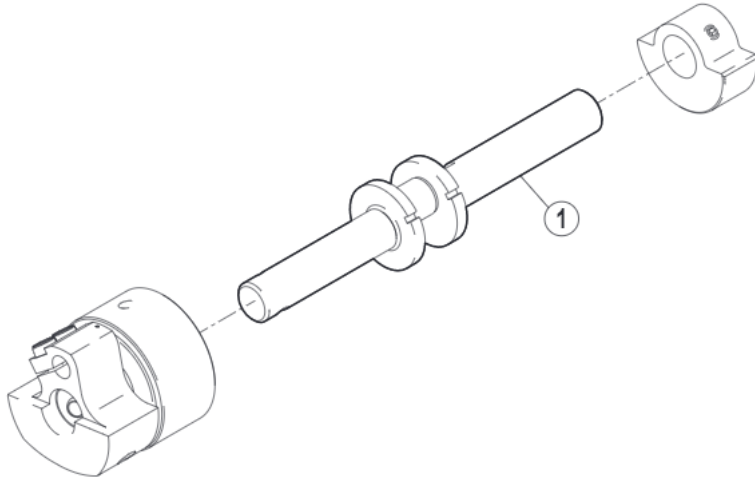

付属品に梱入
Packed in accessory

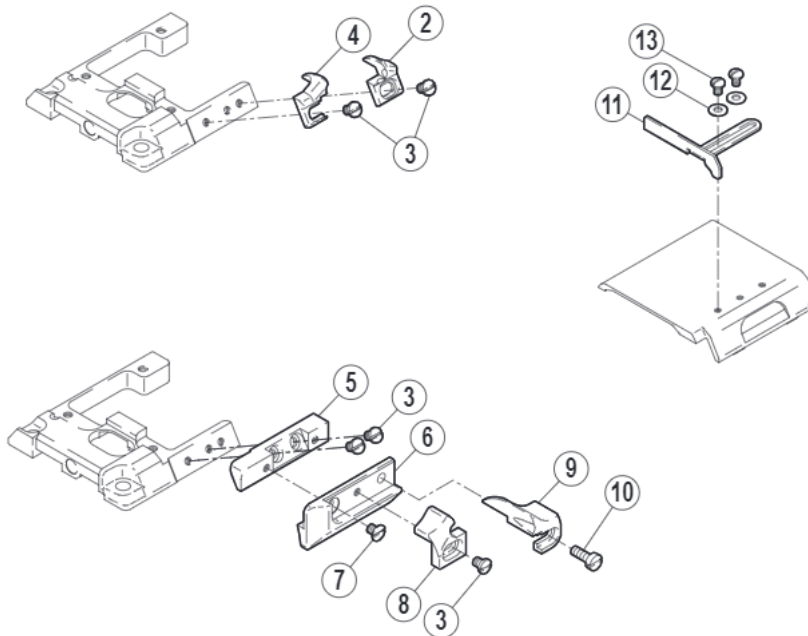

| NO. | PARTS NO. | QTY. | 360° IMAGE | INTO MYLIST |
|-----|--------------------------------------|------|---|-------------|
| 1 | 250517A00009 CRANKSHAFT | 1 |  | |
| 2 | 258169000009 FABRIC GUIDE (RIGHT) | 1 |  | |
| 3 | 007154000009 SCREW | 3 | | |
| 4 | 258170000009 FABRIC GUIDE (LEFT) | 1 |  | |
| 5 | 258174000009 BRACKET | 1 |  | |
| 6 | 258175000009 BRACKET | 1 |  | |
| 7 | 007040000009 SCREW | 1 | | |
| 8 | 257575000009 FABRIC GUIDE (LEFT) | 1 |  | |
| 9 | 257576000009 FABRIC GUIDE (RIGHT) | 1 |  | |
| 10 | 007011000009 SCREW | 1 |  | |
| 11 | 258167000009 FABRIC GUIDE (RIGHT) | 1 |  | |
| 12 | 210585000009 WASHER | 2 |  | |
| 13 | 007156000009 SCREW | 2 | | |





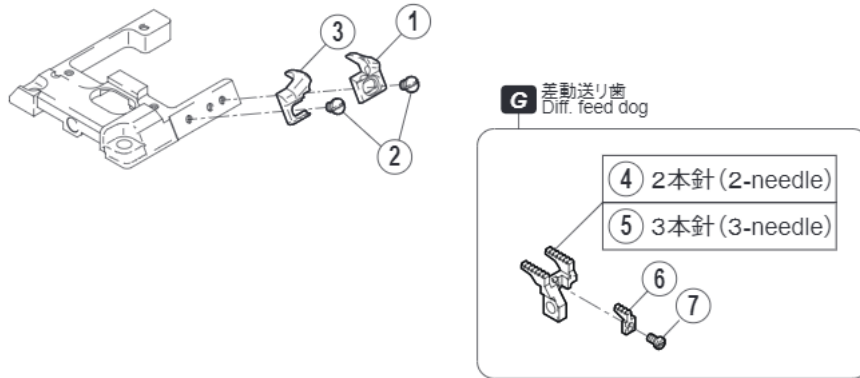



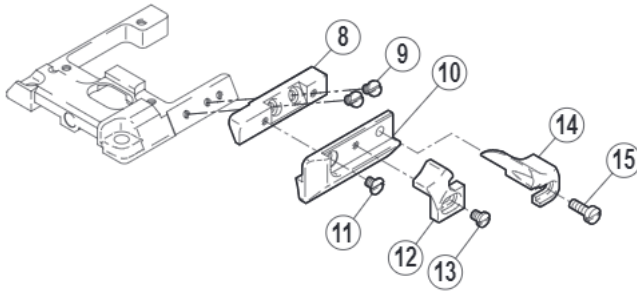

<< >>

● W200P-03F



● W200P-03G



| NO. | PARTS NO. | QTY. | 360° IMAGE | INTO MYLIST |
|-----|--------------------------------------|------|---|-------------|
| 1 | 258169000009 FABRIC GUIDE (RIGHT) | 1 |  | |
| 2 | 007154000009 SCREW | 2 | | |
| 3 | 258170000009 FABRIC GUIDE (LEFT) | 1 |  | |
| 4 | 259262-16F09 DIFF. FEED DOG | 1 |  | |
| 5 | 259263-16F09 DIFF. FEED DOG | 1 |  | |
| 6 | 259264-16F09 AUXILIARY FEED DOG | 1 |  | |
| 7 | 007362000009 SCREW | 1 |  | |
| 8 | 258174000009 BRACKET | 1 |  | |
| 9 | 007154000009 SCREW | 2 | | |
| 10 | 258175000009 BRACKET | 1 |  | |
| 11 | 007040000009 SCREW | 1 | | |
| 12 | 257575000009 FABRIC GUIDE (LEFT) | 1 |  | |
| 13 | 007154000009 SCREW | 1 | | |
| 14 | 257576000009 FABRIC GUIDE (RIGHT) | 1 |  << >> | |





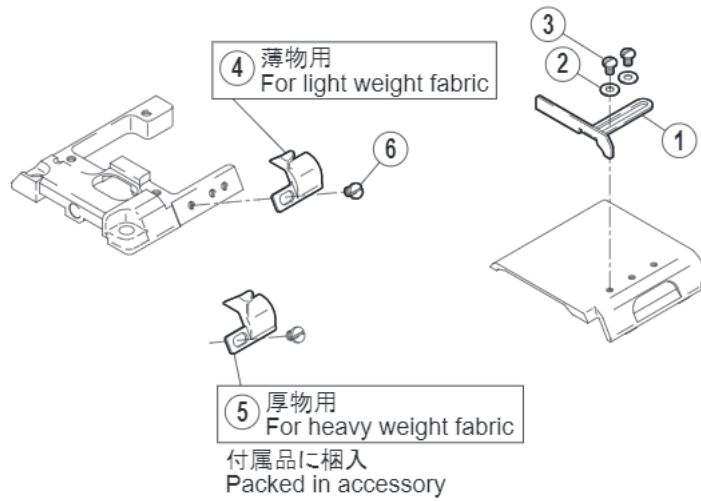

| NO. | PARTS NO. | QTY. | 360° IMAGE | INTO MYLIST |
|-----|-----------------------|------|---|-------------|
| 15 | 007011000009 SCREW | 1 |  | |

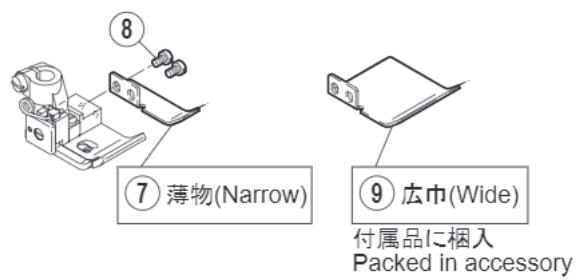
● W200P-08



● W200P-08B



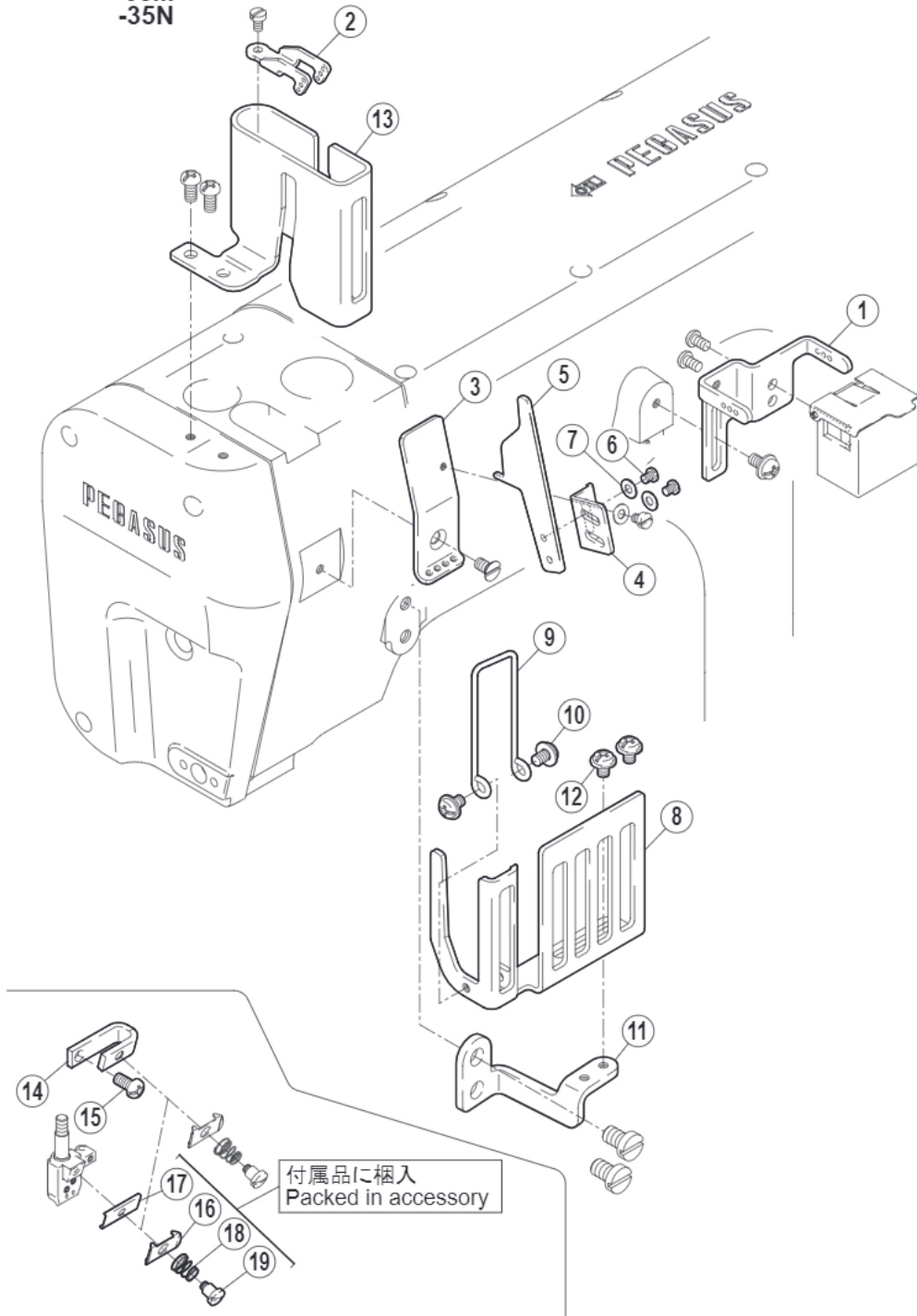

| NO. | PARTS NO. | QTY. | 360° IMAGE | INTO MYLIST |
|-----|--------------------------------------|------|---|-------------|
| 1 | 258167000009 FABRIC GUIDE (RIGHT) | 1 |  | |
| 2 | 210585000009 WASHER | 2 |  | |
| 3 | 007156000009 SCREW | 2 | | |
| 4 | 258178000009 FABRIC GUIDE (LEFT) | 1 |  | |
| 5 | 258179000009 FABRIC GUIDE (LEFT) | 1 |  | |
| 6 | 007154000009 SCREW | 1 | | |
| 7 | 257761A00009 FABRIC GUIDE | 1 |  | |
| 8 | 007031000009 SCREW | 2 | | |
| 9 | 257761000009 FABRIC GUIDE | 1 |  | |

● W200P-01N
-08M
-35N



<< >>







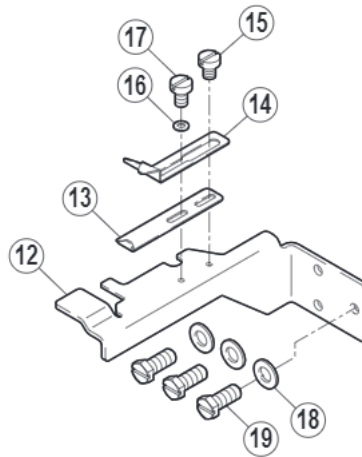
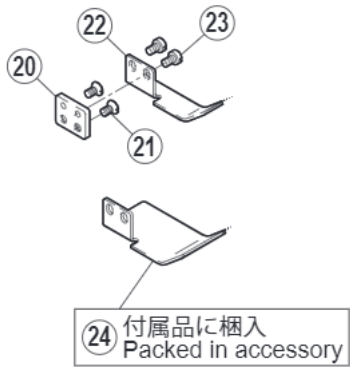
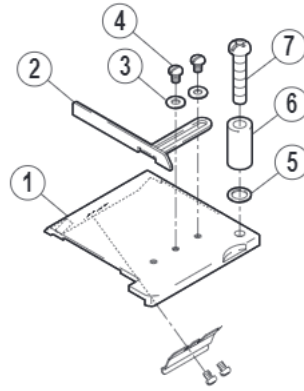
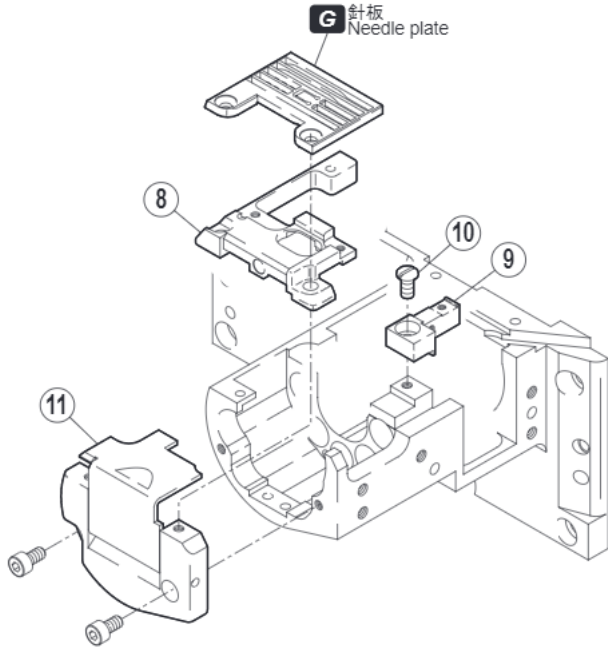

| NO. | PARTS NO. | QTY. | 360° IMAGE | INTO MYLIST |
|-----|-----------------------------------|------|---|-------------|
| 1 | 253678000009 BRACKET | 1 |  | |
| 2 | 253677000009 THREAD GUIDE | 1 |  | |
| 3 | 253684000009 THREAD GUIDE | 1 |  | |
| 4 | 253683000009 BRACKET | 1 |  | |
| 5 | 253682000009 NEEDLE THREAD CAM | 1 |  | |
| 6 | 007154000009 SCREW | 2 | | |
| 7 | 202875000009 WASHER | 2 |  | |
| 8 | 250434000009 SAFETY COVER | 1 |  | |
| 9 | 250226000009 FINGER GUARD | 1 |  | |

● W200P-35B,N

G ゲージパーツ表参照
Refer to the gauge parts list.









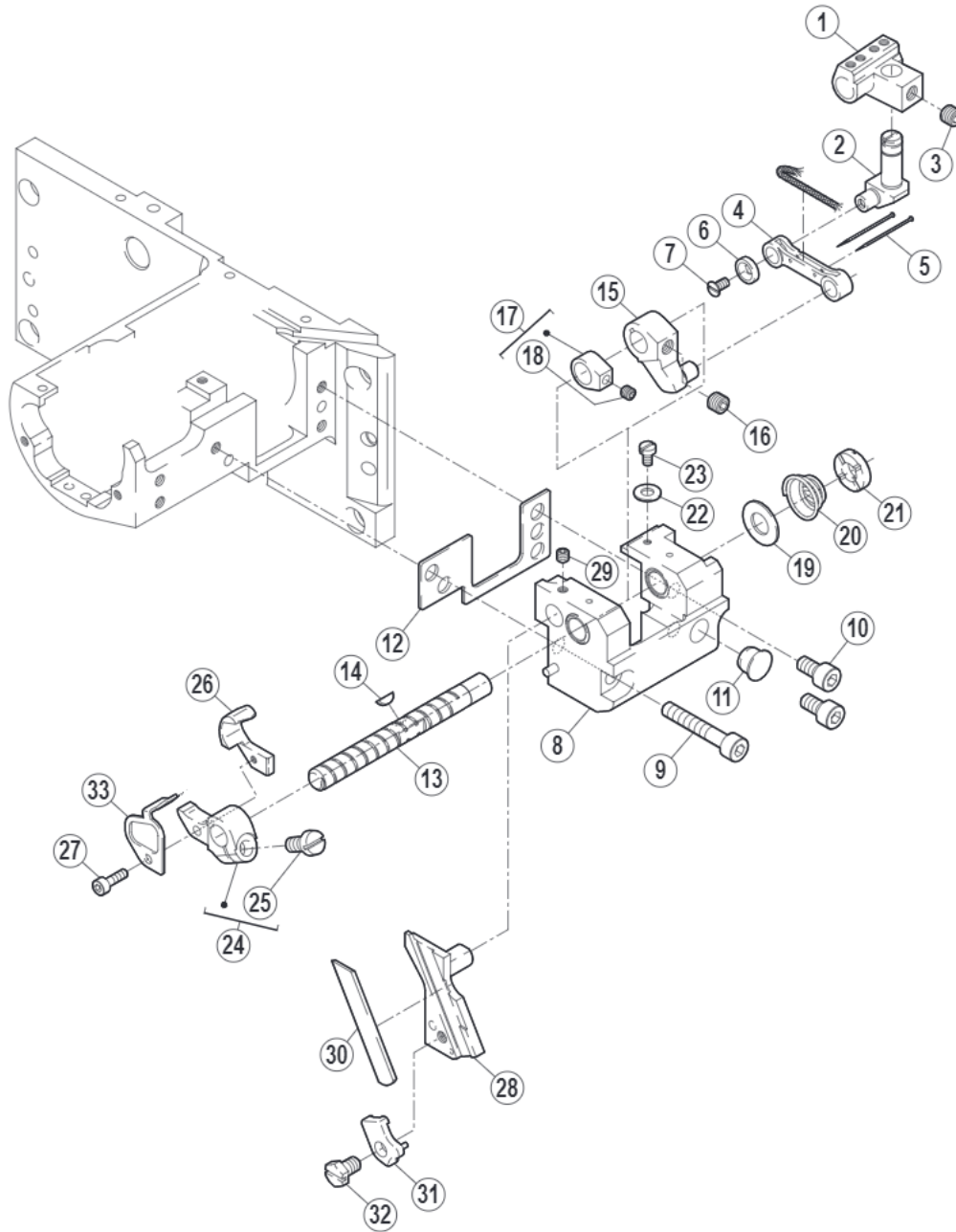

















| NO. | PARTS NO. | QTY. | 360° IMAGE | INTO MYLIST |
|-----|--------------------------------------|------|---|-------------|
| 1 | 6G0078000009 COVER | 1 |  | |
| 2 | 6K0050000009 FABRIC GUARD (RIGHT) | 1 |  | |
| 3 | 210585000009 WASHER | 2 |  | |
| 4 | 007156000009 SCREW | 2 | | |
| 5 | 240314000009 WASHER | 1 |  | |
| 6 | 1H0014000009 SPACER | 1 | | |
| 7 | 007025A00009 SCREW | 1 |  | |
| 8 | 6A0461A91009 BRACKET ASSY | 1 |  | |
| 9 | 6A0313000009 BRACKET | 1 |  | |
| 10 | 007082000009 SCREW | 1 |  | |
| 11 | 6E0050091009 SIDE COVER ASSY | 1 |  | |
| 12 | 6G0079000019 COVER | 1 |  | |
| 13 | 257577A00019 HEMMING GUIDE(LEFT) | 1 |  | |
| 14 | 257578000009 HEMMING GUIDE(RIGHT) | 1 |  | |





| NO. | PARTS NO. | QTY. | 360° IMAGE | INTO MYLIST |
|-----|---------------------------------|------|---|-------------|
| 15 | 007017000009 SCREW | 1 |  | |
| 16 | 303448000009 WASHER | 1 |  | |
| 17 | 007018000009 SCREW | 1 |  | |
| 18 | 204585000009 WASHER | 3 |  | |
| 19 | 004580000009 BOLT | 3 |  | |
| 20 | 257948000009 SPACER | 1 |  | |
| 21 | 007377000009 SCREW | 2 | | |
| 22 | 257949A00009 FABRIC GUARD | 1 |  | |
| 23 | 007031000009 SCREW | 2 | | |
| 24 | 257949000009 AUXILIARY PLATE | 1 |  | |

● W200P-35B,N





| NO. | PARTS NO. | QTY. | 360° IMAGE | INTO MYLIST |
|-----|------------------------------|------|---|-------------|
| 1 | 6A0206000009 JOINT | 1 |  | |
| 2 | 4C0030000009 CRANK PIN | 1 |  | |
| 3 | 004547000009 SCREW | 1 | | |
| 4 | 4L00150B0009 LINK | 1 |  | |
| 5 | 210766000009 PIN | 2 |  | |
| 6 | 1G0011000009 WASHER | 1 |  | |
| 7 | 007041000009 SCREW | 1 |  | |
| 8 | 6A020809P009 BRACKET ASSY | 1 | | |
| 9 | 004502000009 BOLT | 1 |  | |
| 10 | 004500000009 BOLT | 2 |  | |
| 11 | 240227000009 PLUG | 1 |  | |
| 12 | 1L4015000009 GASKET | 1 |  | |
| 13 | 4S0062000009 SHAFT | 1 |  | |
| 14 | 240008000009 KEY | 1 |  | |





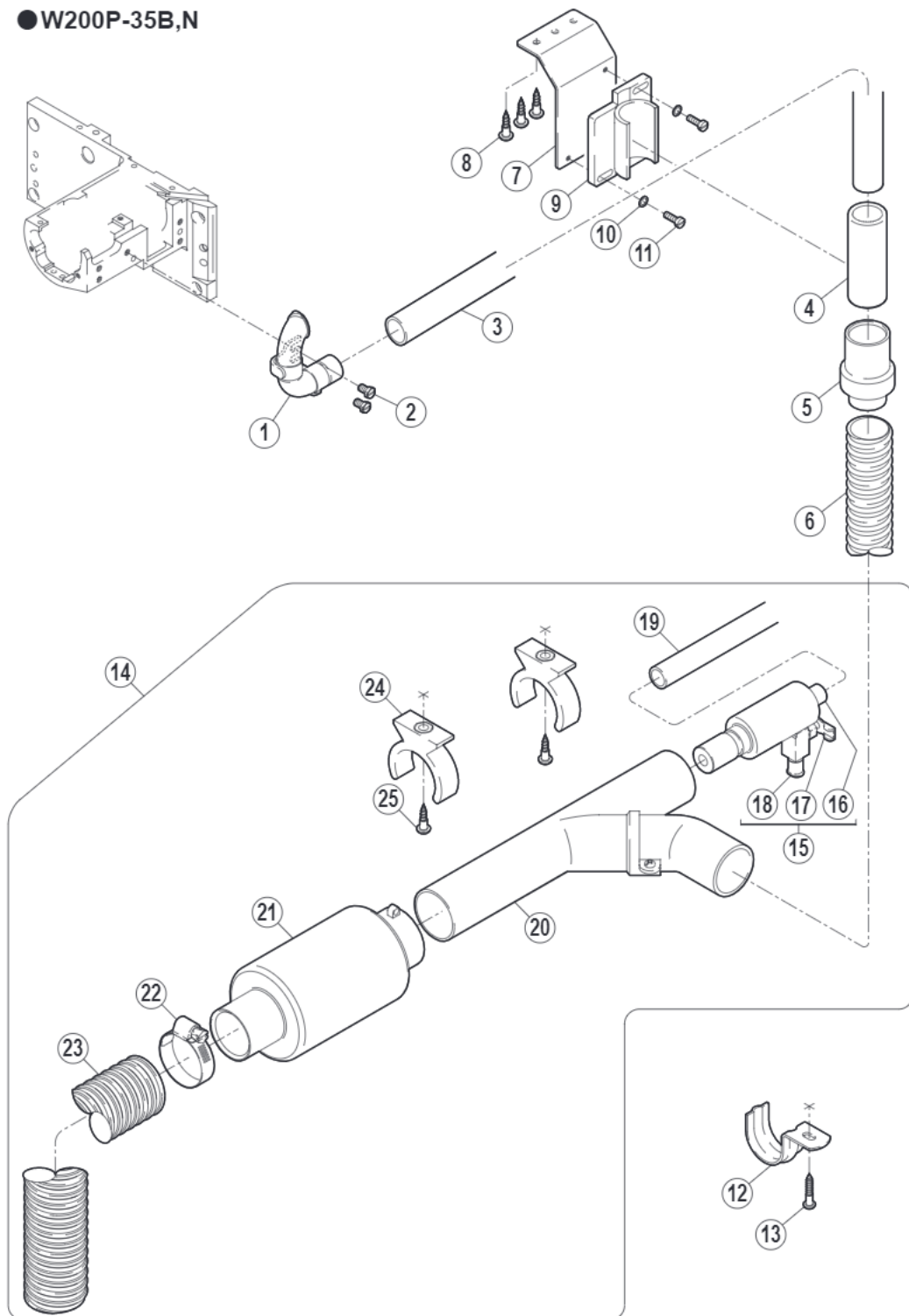



| NO. | PARTS NO. | QTY. | 360° IMAGE | INTO MYLIST |
|-----|------------------------------------|------|---|-------------|
| 15 | 4C0031000009 CRANK | 1 |  | |
| 16 | 004547000009 SCREW | 1 | | |
| 17 | 240549-92009 COLLAR | 1 |  | |
| 18 | 004543000009 SCREW | 1 |  | |
| 19 | 240101000009 WASHER | 1 |  | |
| 20 | 1J1017000009 SPRING | 1 |  | |
| 21 | 255546000009 NUT | 1 |  | |
| 22 | 303448000009 WASHER | 1 |  | |
| 23 | 007009000009 SCREW | 1 |  | |
| 24 | 5G0013092019 UPPER KNIFE HOLDER | 1 |  | |
| 25 | 007028000009 SCREW | 1 |  | |
| 26 | 2A0007000009 UPPER KNIFE | 1 |  | |
| 27 | 004030-HU009 BOLT | 1 |  | |
| 28 | 5G0014000009 LOWER KNIFE HOLDER | 1 |  | |

| NO. | PARTS NO. | QTY. | 360° IMAGE | INTO MYLIST |
|-----|-----------------------------------|------|---|-------------|
| 29 | 004543000009 SCREW | 1 |  | |
| 30 | 2A0008000009 LOWER KNIFE | 1 |  | |
| 31 | 273012000009 LOWER KNIFE CLAMP | 1 |  | |
| 32 | 007173000009 BOLT | 1 |  | |
| 33 | 6G0182000009 WASTE CHUTE | 1 |  | |

● W200P-35B,N









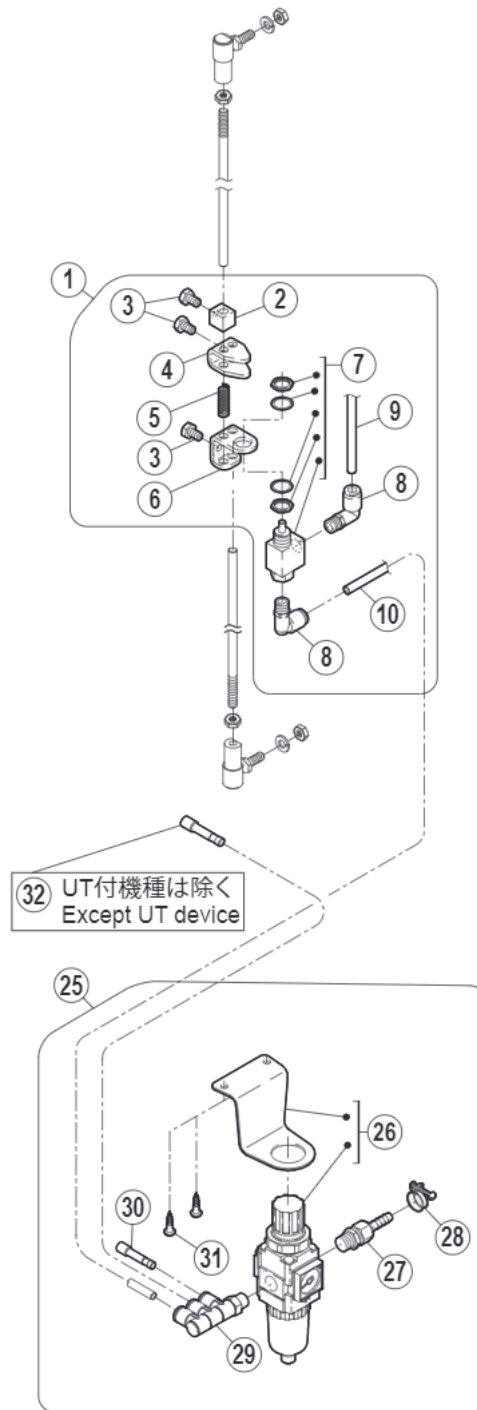
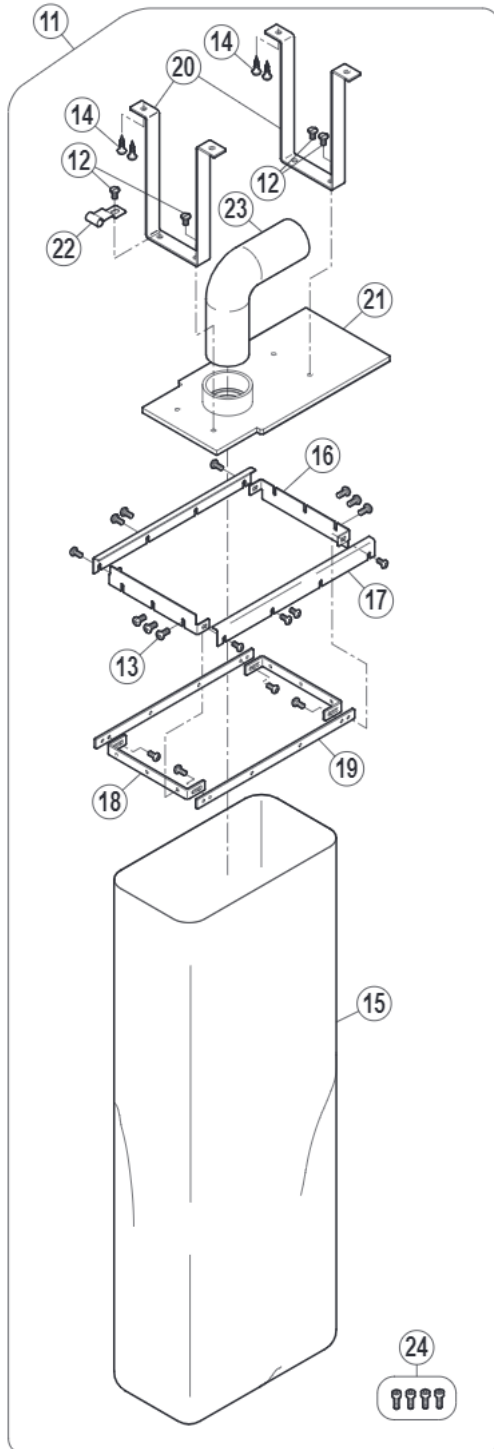













| NO. | PARTS NO. | QTY. | 360° IMAGE | INTO MYLIST |
|-----|-----------------------------|------|---|-------------|
| 1 | 1L6033091009 PIPE ASSY | 1 |  | |
| 2 | 004577000009 BOLT | 2 |  | |
| 3 | 1L7007000009 TUBE | 1 | | |
| 4 | 1L6037000009 PIPE | 1 |  | |
| 5 | 600174000019 CUFF | 1 |  | |
| 6 | 600178000019 HOSE | 1 | | |
| 7 | 6A0211000009 BRACKET | 1 |  | |
| 8 | 004911000009 WOOD SCREW | 3 |  | |
| 9 | 255630-91019 HOLDER ASSY | 1 |  | |
| 10 | 240314000009 WASHER | 2 |  | |
| 11 | 007021000009 SCREW | 2 |  | |
| 12 | 300526000009 HOSE CLIP | 1 |  | |
| 13 | 004905000009 WOOD SCREW | 1 |  | |
| 14 | 300020-91029 VENTURI SET | 1 | « » | |

| NO. | PARTS NO. | QTY. | 360° IMAGE | INTO MYLIST |
|-----|------------------------------|------|---|-------------|
| 15 | 300021-91009 VENTURI ASSY | 1 |  | |
| 16 | 300015000009 VENTURI | 1 |  | |
| 17 | 526002000009 VALVE | 1 |  | |
| 18 | 601095000009 JOINT | 1 |  | |
| 19 | 600176000009 HOSE | 1 |  | |
| 20 | 600158000019 JOINT | 1 | | |
| 21 | 598003000019 SILENCER | 1 |  | |
| 22 | 608009000009 HOSE CLAMP | 1 |  | |
| 23 | 600163000009 HOSE | 1 | | |
| 24 | 604004000009 TUBE CLIP | 2 |  | |
| 25 | 004910000009 WOOD SCREW | 2 |  | |

●W200P-35B,N



| NO. | PARTS NO. | QTY. | 360° IMAGE | INTO MYLIST |
|-----|------------------------------------|------|---|-------------|
| 1 | 300059-91009 PITMAN SWITCH ASSY | 1 |  | |
| 2 | 300469000009 STOPPER | 1 |  | |
| 3 | 004320000009 BOLT | 3 |  | |
| 4 | 300468000009 ACTUATOR | 1 |  | |
| 5 | 240272000009 SPRING | 1 |  | |
| 6 | 306731000009 BRACKET | 1 |  | |
| 7 | 530004000009 AIR VALVE | 1 | | |
| 8 | 601068000009 JOINT | 2 |  | |
| 9 | 600015000009 TUBE | 1 |  | |
| 10 | 600175000009 TUBE | 1 |  | |
| 11 | 305020-91009 DUST BAG ASSY | 1 | | |
| 12 | 004009-10009 SCREW | 4 |  | |
| 13 | 004106000009 SCREW | 18 |  | |
| 14 | 004911000009 SCREW | 4 |  | |

| NO. | PARTS NO. | QTY. | 360° IMAGE | INTO MYLIST |
|-----|---------------------------------------|------|---|-------------|
| 15 | 305021000009 DUST BAG | 1 | | |
| 16 | 305022000009 BRACKET | 2 |  | |
| 17 | 305023000009 BRACKET | 2 |  | |
| 18 | 305024000009 BRACKET | 2 |  | |
| 19 | 305025000009 BRACKET | 2 |  | |
| 20 | 305030000009 BRACKET | 2 |  | |
| 21 | 305107-91009 BRACKET ASSY | 1 | | |
| 22 | 305127000009 FLAT SPRING | 1 |  | |
| 23 | 601124000009 JOINT | 1 | | |
| 24 | 004528000009 BOLT | 4 |  | |
| 25 | 522014-91009 FILTER REGULATOR ASSY | 1 | | |
| 26 | 7B1004000009 FILTER REGULATOR | 1 | | |
| 27 | 601049000009 JOINT | 1 |  | |
| 28 | 608002000009 HOSE CLAMP | 1 |  | |

| NO. | PARTS NO. | QTY. | 360° IMAGE | INTO MYLIST |
|-----|-----------------------|------|---|-------------|
| 29 | 601089000009 JOINT | 1 |  | |
| 30 | 601072000009 PLUG | 1 |  | |
| 31 | 004910000009 SCREW | 2 |  | |
| 32 | 601072000009 PLUG | 1 |  | |

● W200P-01CB

押工
Presser foot **G**

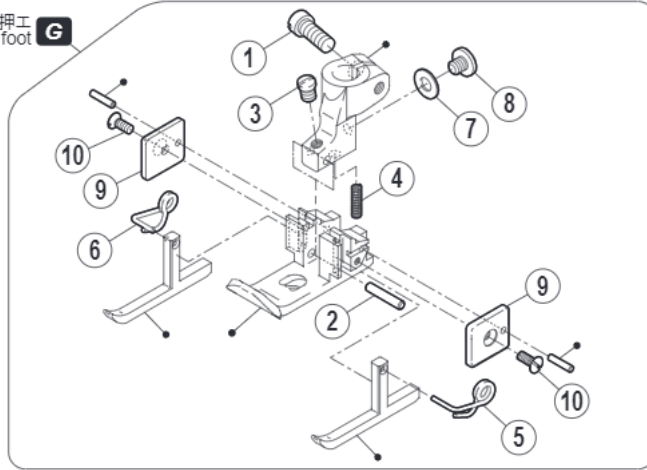

● W200HP-01GB
W200P-03GB



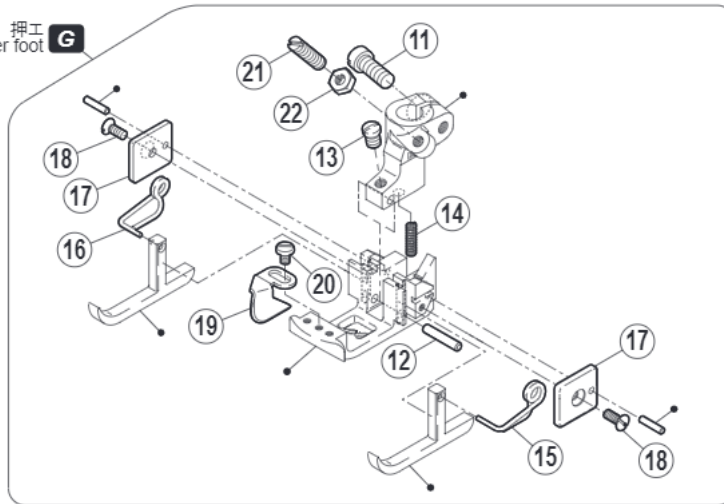





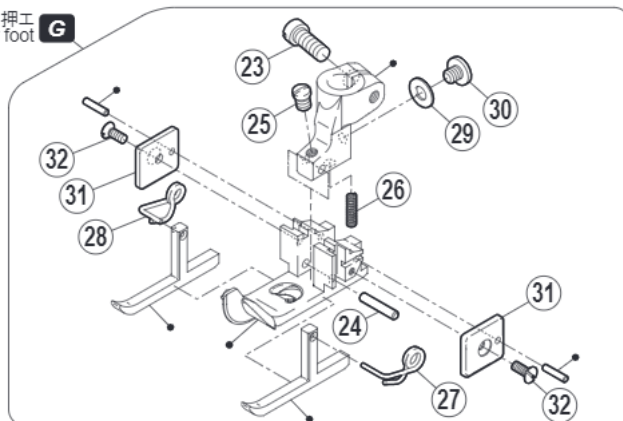

押工
Presser foot **G**





● W200P-03FB

押工
Presser foot **G**



| NO. | PARTS NO. | QTY. | 360° IMAGE | INTO MYLIST |
|-----|-------------------------------|------|---|-------------|
| 1 | 001170-30009 SCREW | 1 |  | |
| 2 | 207515000009 PIN | 1 |  | |
| 3 | 001222000009 SCREW | 1 | | |
| 4 | 207544000009 SPRING | 1 |  | |
| 5 | 257852000009 SPRING(RIGHT) | 1 |  | |
| 6 | 257853000009 SPRING(LEFT) | 1 |  | |
| 7 | 202875000009 WASHER | 1 |  | |
| 8 | 005519000009 SCREW | 1 | | |
| 9 | 236457000009 GUIDE | 2 |  | |
| 10 | 007119000009 SCREW | 2 | | |
| 11 | 001170-30009 SCREW | 1 |  | |
| 12 | 207515000009 PIN | 1 |  | |
| 13 | 001222000009 SCREW | 1 | | |
| 14 | 207544000009 SPRING | 1 |  | |

| NO. | PARTS NO. | QTY. | 360° IMAGE | INTO MYLIST |
|-----|--------------------------------|------|---|-------------|
| 15 | 1J1035000009 SPRING (LEFT) | 1 |  | |
| 16 | 1J1036000009 SPRING (RIGHT) | 1 |  | |
| 17 | 236457000009 GUIDE | 2 |  | |
| 18 | 007119000009 SCREW | 2 | | |
| 19 | 5K0068000009 GUIDE | 1 |  | |
| 20 | 007120000009 SCREW | 1 | | |
| 21 | 005618000009 SCREW | 1 |  | |
| 22 | 005409000009 NUT | 1 |  | |
| 23 | 001170-30009 SCREW | 1 |  | |
| 24 | 207515000009 PIN | 1 |  | |
| 25 | 001222000009 SCREW | 1 | | |
| 26 | 207544000009 SPRING | 1 |  | |
| 27 | 257852000009 SPRING(RIGHT) | 1 |  | |
| 28 | 257853000009 SPRING(LEFT) | 1 |  | |

| NO. | PARTS NO. | QTY. | 360° IMAGE | INTO MYLIST |
|-----|------------------------|------|---|-------------|
| 29 | 202875000009 WASHER | 1 |  | |
| 30 | 005519000009 SCREW | 1 | | |
| 31 | 236457000009 GUIDE | 2 |  | |
| 32 | 007119000009 SCREW | 2 | | |

● W200P-01N
-08A,M

押工
Presser foot **G**

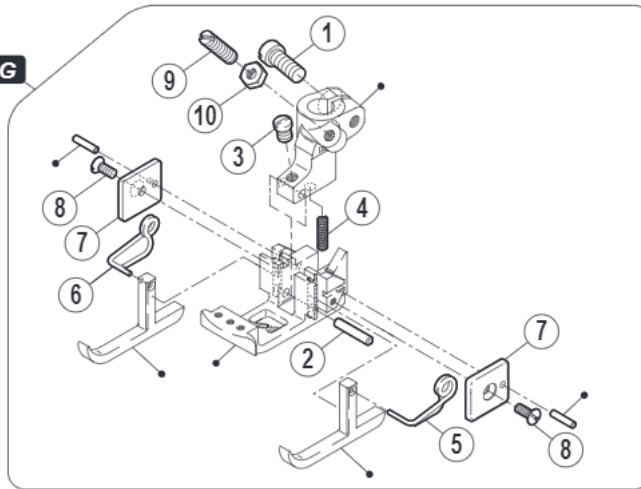

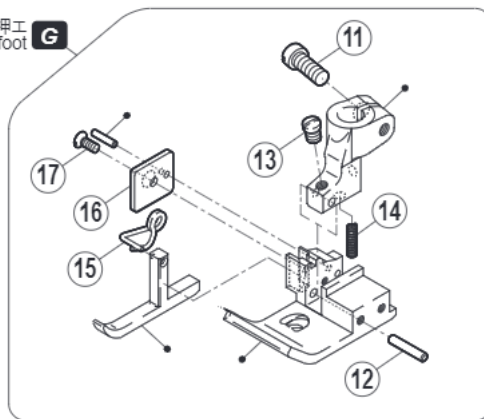

● W200P-08B
-35B,N

押工
Presser foot **G**



| NO. | PARTS NO. | QTY. | 360° IMAGE | INTO MYLIST |
|-----|--------------------------------|------|---|-------------|
| 1 | 001170-30009 SCREW | 1 |  | |
| 2 | 207515000009 PIN | 1 |  | |
| 3 | 001222000009 SCREW | 1 | | |
| 4 | 207544000009 SPRING | 1 |  | |
| 5 | 1J1035000009 SPRING (LEFT) | 1 |  | |
| 6 | 1J1036000009 SPRING (RIGHT) | 1 |  | |
| 7 | 236457000009 GUIDE | 2 |  | |
| 8 | 007119000009 SCREW | 2 | | |
| 9 | 005618000009 SCREW | 1 |  | |
| 10 | 005409000009 NUT | 1 |  | |
| 11 | 001170-30009 SCREW | 1 |  | |
| 12 | 207515000009 PIN | 1 |  | |
| 13 | 001222000009 SCREW | 1 | | |
| 14 | 207544000009 SPRING | 1 |  | |

| NO. | PARTS NO. | QTY. | 360° IMAGE | INTO MYLIST |
|-----|------------------------------|------|---|-------------|
| 15 | 257853000009 SPRING(LEFT) | 1 |  | |
| 16 | 236457000009 GUIDE | 1 |  | |
| 17 | 007119000009 SCREW | 1 | | |













W200P ゲージパーツ表 (1)







W200P GAUGE PARTS LIST(1)



























| マシン形式 | ゲージ | 針留 | 針板 | 主送り歯 | 差動送り歯 | 押工 | ルーパー | 針受 (前) | 針受 (後) | スプレッダー | 針 |
|---------------------|-------|---------------|--------------|---------------|----------------|--------------|--------------|--------------|--------------|--------------|---------------|
| MACHINE TYPE / SPEC | GAUGE | NEEDLE HOLDER | NEEDLE PLATE | MAIN FEED DOG | DIFF. FEED DOG | PRESSER FOOT | LOOPER | NEEDLE GUARD | | SPREADER | NEEDLE |
| | | | | | | | | FRONT | REAR | | |
| W264P-01CB | 232 | 257541-32019 | 259612B32019 | 259146-16F09 | 259254-16F19 | 257460-32009 | 257566000009 | 259572000009 | 259573-92009 | 257565000009 | UY128GAS #9S |
| | 240 | 257541-40019 | 259612B40019 | | | 257460-40009 | | | | | |
| | 248 | 257541-48019 | 259612B48019 | 257460-48009 | | | | | | | |
| | 356 | 257542-56019 | 259614B56019 | 259148-16F09 | 259255-16F19 | 257461-56009 | | | | | |
| | 364 | 257542-64019 | 259614B64019 | 257461-64009 | | | | | | | |
| W264HP-01GB | 356 | 257542-56019 | 259614B56019 | 259148-16F09 | 259255-16F19 | 3Q0073035609 | 257566000009 | 259572000009 | 259573-92009 | 257565000009 | UY128GAS #10S |
| | 364 | 257542-64019 | 259614B64019 | 3Q0073036409 | | | | | | | |
| W264P-01NC | 356 | 257542-56019 | 259622C56019 | 259148-16F09 | 259255-16F19 | 3Q0073A35809 | 257566000009 | 259572000009 | 259573-92009 | 257565000009 | UY128GAS #10S |
| W264P-03FB | 240 | 257541-40019 | 259611B40019 | 259146-16F09 | 259265-16F09 | 257467-40009 | 257566000009 | 259572000009 | 259573-92009 | 257565000009 | UY128GAS #9S |
| | 248 | 257541-48019 | 259615B48019 | 259149-16F09 | | 257467-48009 | | | | | |
| | 356 | 257542-56019 | 259608B56019 | 259147-16F09 | 259266-16F09 | 257468-56009 | | | | | |
| | 364 | 257542-64019 | 259608B64019 | 257468-64009 | | | | | | | |
| W264P-03GB | 240 | 257541-40019 | 259618B40019 | 259146-16F09 | 259262-16F09 | 3Q0073024009 | 257566000009 | 259572000009 | 259573-92009 | 257565000009 | UY128GAS #9S |
| | 248 | 257541-48019 | 259618B48019 | 3Q0073024809 | | | | | | | |
| | 356 | 257542-56019 | 259619B56019 | 259148-16F09 | 259263-16F09 | 3Q0073035609 | | | | | |
| | 364 | 257542-64019 | 259619B64019 | 3Q0073036409 | | | | | | | |
| W264P-08AB | 240 | 257541-40019 | 259610B40019 | 259146-16F09 | 259252-16F19 | 3Q0073A24009 | 257566000009 | 259572000009 | 259573-92009 | 257565000009 | UY128GAS #9S |
| | 248 | 257541-48019 | 259610B48019 | 3Q0073A24809 | | | | | | | |
| | 356 | 257542-56019 | 259609B56019 | 259148-16F09 | 259251-16F19 | 3Q0073A35609 | | | | | |
| | 364 | 257542-64019 | 259609B64019 | 3Q0073A36409 | | | | | | | |
| W264P-08AC | 240 | 257541-40019 | 259610C40019 | 259146-16F09 | 259252-16F19 | 3Q0073A24009 | 257566000009 | 259572000009 | 259573-92009 | 257565000009 | UY128GAS #9S |
| | 248 | 257541-48019 | 259610C48019 | 3Q0073A24809 | | | | | | | |
| | 356 | 257542-56019 | 259609C56019 | 259148-16F09 | 259251-16F19 | 3Q0073A35609 | | | | | |
| | 364 | 257542-64019 | 259609C64019 | 3Q0073A36409 | | | | | | | |



| NO. | PARTS NO. | QTY. | 360° IMAGE | INTO MYLIST |
|-----|-----------------------------------|------|---|-------------|
| 1 | 257460-32009 PRESSER FOOT ASSY | 1 |  | |
| 2 | 257460-40009 PRESSER FOOT ASSY | 1 |  | |
| 3 | 257460-48009 PRESSER FOOT ASSY | 1 |  | |
| 4 | 257461-56009 PRESSER FOOT ASSY | 1 |  | |
| 5 | 257461-64009 PRESSER FOOT ASSY | 1 |  | |
| 6 | 257467-40009 PRESSER FOOT ASSY | 1 |  | |
| 7 | 257467-48009 PRESSER FOOT ASSY | 1 |  | |
| 8 | 257468-56009 PRESSER FOOT ASSY | 1 | | |
| 9 | 257468-64009 PRESSER FOOT ASSY | 1 |  | |
| 10 | 257541-32019 NEEDLE HOLDER | 1 |  | |
| 11 | 257541-40019 NEEDLE HOLDER | 1 |  | |
| 12 | 257541-48019 NEEDLE HOLDER | 1 |  | |
| 13 | 257542-56019 NEEDLE HOLDER | 1 |  | |
| 14 | 257542-64019 NEEDLE HOLDER | 1 |  | |

| NO. | PARTS NO. | QTY. | 360° IMAGE | INTO MYLIST |
|-----|--------------------------------|------|---|-------------|
| 15 | 257565000009 SPREADER | 1 |  | |
| 16 | 257566000009 LOOPER | 1 |  | |
| 17 | 259146-16F09 MAIN FEED DOG | 1 |  | |
| 18 | 259147-16F09 MAIN FEED DOG | 1 |  | |
| 19 | 259148-16F09 MAIN FEED DOG | 1 |  | |
| 20 | 259149-16F09 MAIN FEED DOG | 1 |  | |
| 21 | 259251-16F19 DIFF. FEED DOG | 1 |  | |
| 22 | 259252-16F19 DIFF. FEED DOG | 1 |  | |
| 23 | 259254-16F19 DIFF. FEED DOG | 1 |  | |
| 24 | 259255-16F19 DIFF. FEED DOG | 1 |  | |
| 25 | 259262-16F09 DIFF. FEED DOG | 1 |  | |
| 26 | 259263-16F09 DIFF. FEED DOG | 1 |  | |
| 27 | 259265-16F09 DIFF. FEED DOG | 1 |  | |
| 28 | 259266-16F09 DIFF. FEED DOG | 1 |  | |

| NO. | PARTS NO. | QTY. | 360° IMAGE | INTO MYLIST |
|-----|-------------------------------------|------|---|-------------|
| 29 | 259572000009 NEEDLE GUARD(FRONT) | 1 |  | |
| 30 | 259573-92009 NEEDLE GUARD(REAR) | 1 |  | |
| 31 | 259608B56019 NEEDLE PLATE | 1 |  | |
| 32 | 259608B64019 NEEDLE PLATE | 1 |  | |
| 33 | 259609B56019 NEEDLE PLATE | 1 |  | |
| 34 | 259609B64019 NEEDLE PLATE | 1 |  | |
| 35 | 259609C56019 NEEDLE PLATE | 1 |  | |
| 36 | 259609C64019 NEEDLE PLATE | 1 |  | |
| 37 | 259610B40019 NEEDLE PLATE | 1 |  | |
| 38 | 259610B48019 NEEDLE PLATE | 1 |  | |
| 39 | 259610C40019 NEEDLE PLATE | 1 |  | |
| 40 | 259610C48019 NEEDLE PLATE | 1 |  | |
| 41 | 259611B40019 NEEDLE PLATE | 1 |  | |
| 42 | 259612B32019 NEEDLE PLATE | 1 |  | |

| NO. | PARTS NO. | QTY. | 360° IMAGE | INTO MYLIST |
|-----|------------------------------|------|---|-------------|
| 43 | 259612B40019 NEEDLE PLATE | 1 |  | |
| 44 | 259612B48019 NEEDLE PLATE | 1 |  | |
| 45 | 259614B56019 NEEDLE PLATE | 1 |  | |
| 46 | 259614B64019 NEEDLE PLATE | 1 |  | |
| 47 | 259615B48019 NEEDLE PLATE | 1 |  | |
| 48 | 259618B40019 NEEDLE PLATE | 1 | | |
| 49 | 259618B48019 NEEDLE PLATE | 1 |  | |
| 50 | 259619B56019 NEEDLE PLATE | 1 |  | |
| 51 | 259619B64019 NEEDLE PLATE | 1 |  | |
| 52 | 259622C56019 NEEDLE PLATE | 1 |  | |
| 53 | 3Q0073024009 PRESSER FOOT | 1 | | |
| 54 | 3Q0073024809 PRESSER FOOT | 1 |  | |
| 55 | 3Q0073035609 PRESSER FOOT | 1 | | |
| 56 | 3Q0073036409 PRESSER FOOT | 1 |  | |

| NO. | PARTS NO. | QTY. | 360° IMAGE | INTO MYLIST |
|-----|------------------------------|------|---|-------------|
| 57 | 3Q0073A24009 PRESSER FOOT | 1 |  | |
| 58 | 3Q0073A24809 PRESSER FOOT | 1 |  | |
| 59 | 3Q0073A35609 PRESSER FOOT | 1 |  | |
| 60 | 3Q0073A36409 PRESSER FOOT | 1 |  | |













W200P ゲージパーツ表 (2)















W200P GAUGE PARTS LIST(2)













| マシン形式 | ゲージ | 針留 | 針板 | 主送り歯 | 差動送り歯 | 押工 | ルーパー | 針受(前) | 針受(後) | スプレッダー | 針 |
|---------------------|-------|---------------|--------------|---------------|----------------|--------------|--------------|--------------|--------------|--------------|---------------|
| MACHINE TYPE / SPEC | GAUGE | NEEDLE HOLDER | NEEDLE PLATE | MAIN FEED DOG | DIFF. FEED DOG | PRESSER FOOT | LOOPER | NEEDLE GUARD | | SPREADER | NEEDLE |
| | | | | | | | | FRONT | REAR | | |
| W264P-08BB | 232 | 257541-32019 | 259610B32019 | 259146-16F09 | 259252-16F19 | 257479-32009 | 257566000009 | 259572000009 | 259573-92009 | 257565000009 | UY128GAS #9S |
| | 240 | 257541-40019 | 259610B40019 | | | 257479-40009 | | | | | |
| | 248 | 257541-48019 | 259610B48019 | 257479-48009 | | | | | | | |
| | 356 | 257542-56019 | 259609B56019 | 257480-56009 | | | | | | | |
| W264P-08BC | 240 | 257541-40019 | 259610C40019 | 259146-16F09 | 259252-16F19 | 257479-40009 | 257566000009 | 259572000009 | 259573-92009 | 257565000009 | UY128GAS #9S |
| | 248 | 257541-48019 | 259610C48019 | | | 257479-48009 | | | | | |
| | 356 | 257542-56019 | 259609C56019 | 257480-56009 | | | | | | | |
| | 364 | 257542-64019 | 259609C64019 | 257480-64009 | | | | | | | |
| W264P-08MC | 356 | 257542-56019 | 259623C56019 | 259148-16F09 | 259251-16F19 | 3Q0073A35609 | 257566000009 | 259572000009 | 259573-92009 | 257565000009 | UY128GAS #10S |
| W264P-35BB | 248 | 257541-48019 | 2Q0011B24819 | 3B0007016F09 | 3G0010016F09 | 3Q0038024809 | 257566000009 | 259572000009 | 259573-92009 | 257565000009 | UY128GAS #9S |
| | 356 | 257542-56019 | 2Q0013B35619 | 3B0008016F09 | 3G0011016F09 | 3Q0039035609 | | | | | |
| | 364 | 257542-64019 | 2Q0013B36409 | | | 3Q0039036409 | | | | | |
| W264P-35NB | 248 | 257541-48019 | 2Q0019B24809 | 3B0007016F09 | 3G0010016F09 | 3Q0038024809 | 257566000009 | 259572000009 | 259573-92009 | 257565000009 | UY128GAS #10S |
| | 356 | 257542-56019 | 2Q0020B35609 | 3B0008016F09 | 3G0011016F09 | 3Q0039035609 | | | | | |



| NO. | PARTS NO. | QTY. | 360° IMAGE | INTO MYLIST |
|-----|-----------------------------------|------|---|-------------|
| 1 | 257479-32009 PRESSER FOOT ASSY | 1 |  | |
| 2 | 257479-40009 PRESSER FOOT ASSY | 1 |  | |
| 3 | 257479-48009 PRESSER FOOT ASSY | 1 |  | |
| 4 | 257480-56009 PRESSER FOOT ASSY | 1 |  | |
| 5 | 257480-64009 PRESSER FOOT ASSY | 1 |  | |
| 6 | 257541-32019 NEEDLE HOLDER | 1 |  | |
| 7 | 257541-40019 NEEDLE HOLDER | 1 |  | |
| 8 | 257541-48019 NEEDLE HOLDER | 1 |  | |
| 9 | 257542-56019 NEEDLE HOLDER | 1 |  | |
| 10 | 257542-64019 NEEDLE HOLDER | 1 |  | |
| 11 | 257565000009 SPREADER | 1 |  | |
| 12 | 257566000009 LOOPER | 1 |  | |
| 13 | 259146-16F09 MAIN FEED DOG | 1 |  | |
| 14 | 259148-16F09 MAIN FEED DOG | 1 |  | |

| NO. | PARTS NO. | QTY. | 360° IMAGE | INTO MYLIST |
|-----|-------------------------------------|------|---|-------------|
| 15 | 259251-16F19 DIFF. FEED DOG | 1 |  | |
| 16 | 259252-16F19 DIFF. FEED DOG | 1 |  | |
| 17 | 259572000009 NEEDLE GUARD(FRONT) | 1 |  | |
| 18 | 259573-92009 NEEDLE GUARD(REAR) | 1 |  | |
| 19 | 259609B56019 NEEDLE PLATE | 1 |  | |
| 20 | 259609B64019 NEEDLE PLATE | 1 |  | |
| 21 | 259609C56019 NEEDLE PLATE | 1 |  | |
| 22 | 259609C64019 NEEDLE PLATE | 1 |  | |
| 23 | 259610B32019 NEEDLE PLATE | 1 |  | |
| 24 | 259610B40019 NEEDLE PLATE | 1 |  | |
| 25 | 259610B48019 NEEDLE PLATE | 1 |  | |
| 26 | 259610C40019 NEEDLE PLATE | 1 |  | |
| 27 | 259610C48019 NEEDLE PLATE | 1 |  | |
| 28 | 259623C56019 NEEDLE PLATE | 1 |  | |

| NO. | PARTS NO. | QTY. | 360° IMAGE | INTO MYLIST |
|-----|--------------------------------|------|---|-------------|
| 29 | 2Q0011B24819 NEEDLE PLATE | 1 | | |
| 30 | 2Q0013B35619 NEEDLE PLATE | 1 |  | |
| 31 | 2Q0013B36409 NEEDLE PLATE | 1 |  | |
| 32 | 2Q0019B24809 NEEDLE PLATE | 1 | | |
| 33 | 2Q0020B35609 NEEDLE PLATE | 1 |  | |
| 34 | 3B0007016F09 MAIN FEED DOG | 1 |  | |
| 35 | 3B0008016F09 MAIN FEED DOG | 1 |  | |
| 36 | 3G0010016F09 DIFF. FEED DOG | 1 |  | |
| 37 | 3G0011016F09 DIFF. FEED DOG | 1 |  | |
| 38 | 3Q0038024809 PRESSER FOOT | 1 |  | |
| 39 | 3Q0039035609 PRESSER FOOT | 1 |  | |
| 40 | 3Q0039036409 PRESSER FOOT | 1 |  | |
| 41 | 3Q0073A35609 PRESSER FOOT | 1 |  | |







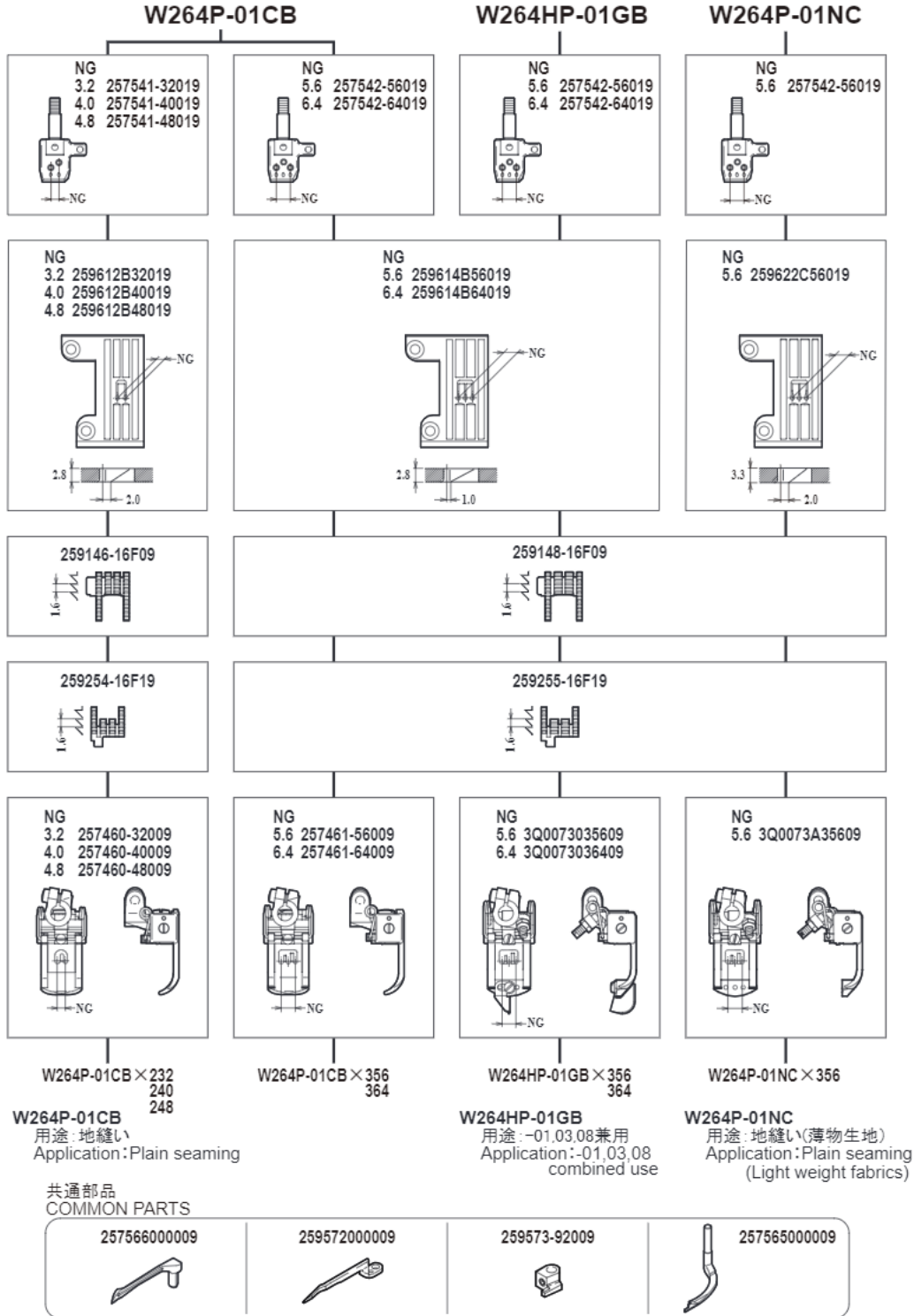





<< >>

W200P ゲージパーツ系列構成図

W200P GAUGE PARTS CHART



| NO. | PARTS NO. | QTY. | 360° IMAGE | INTO MYLIST |
|-----|-----------------------------------|------|---|-------------|
| 1 | 257460-32009 PRESSER FOOT ASSY | 1 |  | |
| 2 | 257460-40009 PRESSER FOOT ASSY | 1 |  | |
| 3 | 257460-48009 PRESSER FOOT ASSY | 1 |  | |
| 4 | 257461-56009 PRESSER FOOT ASSY | 1 |  | |
| 5 | 257461-64009 PRESSER FOOT ASSY | 1 |  | |
| 6 | 257541-32019 NEEDLE HOLDER | 1 |  | |
| 7 | 257541-40019 NEEDLE HOLDER | 1 |  | |
| 8 | 257541-48019 NEEDLE HOLDER | 1 |  | |
| 9 | 257542-56019 NEEDLE HOLDER | 1 |  | |
| 10 | 257542-64019 NEEDLE HOLDER | 1 |  | |
| 11 | 257565000009 SPREADER | 1 |  | |
| 12 | 257566000009 LOOPER | 1 |  | |
| 13 | 259146-16F09 MAIN FEED DOG | 1 |  | |
| 14 | 259148-16F09 MAIN FEED DOG | 1 |  | |

| NO. | PARTS NO. | QTY. | 360° IMAGE | INTO MYLIST |
|-----|-------------------------------------|------|---|-------------|
| 15 | 259254-16F19 DIFF. FEED DOG | 1 |  | |
| 16 | 259255-16F19 DIFF. FEED DOG | 1 |  | |
| 17 | 259572000009 NEEDLE GUARD(FRONT) | 1 |  | |
| 18 | 259573-92009 NEEDLE GUARD(REAR) | 1 |  | |
| 19 | 259612B32019 NEEDLE PLATE | 1 |  | |
| 20 | 259612B40019 NEEDLE PLATE | 1 |  | |
| 21 | 259612B48019 NEEDLE PLATE | 1 |  | |
| 22 | 259614B56019 NEEDLE PLATE | 1 |  | |
| 23 | 259614B64019 NEEDLE PLATE | 1 |  | |
| 24 | 259622C56019 NEEDLE PLATE | 1 |  | |
| 25 | 3Q0073035609 PRESSER FOOT | 1 | | |
| 26 | 3Q0073036409 PRESSER FOOT | 1 |  | |
| 27 | 3Q0073A35609 PRESSER FOOT | 1 |  | |

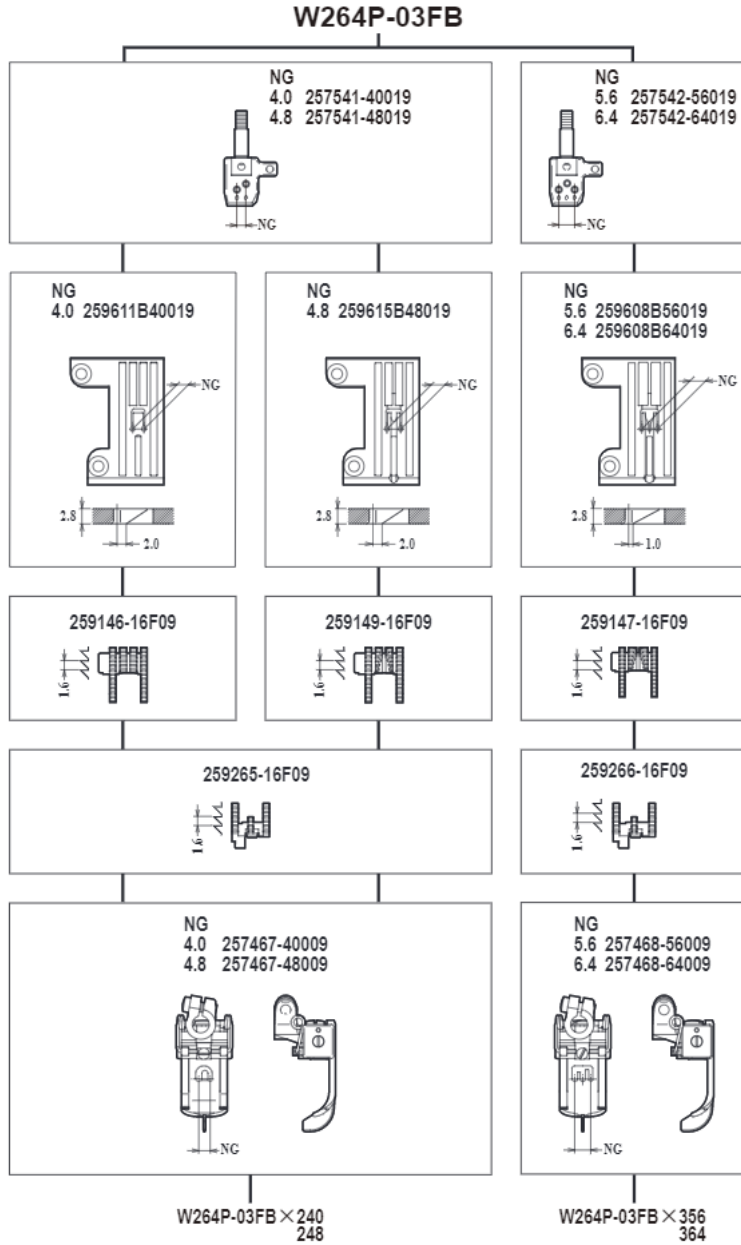





W264P-03FB
 用途: カバリング
 Application: Covering

共通部品
 COMMON PARTS

| | | | |
|---|---|---|---|
| 257566000009 | 259572000009 | 259573-92009 | 257565000009 |
|  |  |  |  |

| NO. | PARTS NO. | QTY. | 360° IMAGE | INTO MYLIST |
|-----|-------------------------------------|------|---|-------------|
| 1 | 257467-40009 PRESSER FOOT ASSY | 1 |  | |
| 2 | 257467-48009 PRESSER FOOT ASSY | 1 |  | |
| 3 | 257541-40019 NEEDLE HOLDER | 1 |  | |
| 4 | 257541-48019 NEEDLE HOLDER | 1 |  | |
| 5 | 257542-56019 NEEDLE HOLDER | 1 |  | |
| 6 | 257542-64019 NEEDLE HOLDER | 1 |  | |
| 7 | 257565000009 SPREADER | 1 |  | |
| 8 | 257566000009 LOOPER | 1 |  | |
| 9 | 259146-16F09 MAIN FEED DOG | 1 |  | |
| 10 | 259147-16F09 MAIN FEED DOG | 1 |  | |
| 11 | 259149-16F09 MAIN FEED DOG | 1 |  | |
| 12 | 259265-16F09 DIFF. FEED DOG | 1 |  | |
| 13 | 259266-16F09 DIFF. FEED DOG | 1 |  | |
| 14 | 259572000009 NEEDLE GUARD(FRONT) | 1 |  | |

| NO. | PARTS NO. | QTY. | 360° IMAGE | INTO MYLIST |
|-----|------------------------------------|------|---|-------------|
| 15 | 259573-92009 NEEDLE GUARD(REAR) | 1 |  | |
| 16 | 259608B56019 NEEDLE PLATE | 1 |  | |
| 17 | 259608B64019 NEEDLE PLATE | 1 |  | |
| 18 | 259611B40019 NEEDLE PLATE | 1 |  | |
| 19 | 259615B48019 NEEDLE PLATE | 1 |  | |



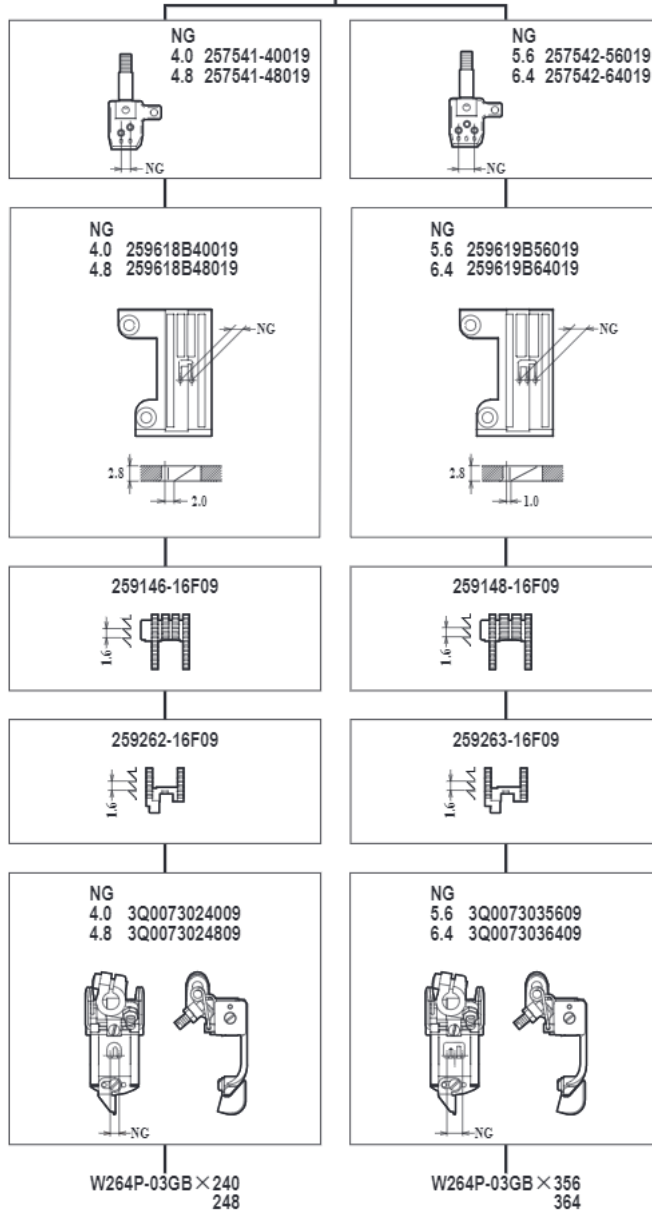

W264P-03GB



W264P-03GB
 用途: カバリング
 Application: Covering

共通部品
 COMMON PARTS

| | | | |
|--------------|--------------|--------------|--------------|
| 257566000009 | 259572000009 | 259573-92009 | 257565000009 |
| | | | |

| NO. | PARTS NO. | QTY. | 360° IMAGE | INTO MYLIST |
|-----|-------------------------------------|------|---|-------------|
| 1 | 257541-40019 NEEDLE HOLDER | 1 |  | |
| 2 | 257541-48019 NEEDLE HOLDER | 1 |  | |
| 3 | 257542-56019 NEEDLE HOLDER | 1 |  | |
| 4 | 257542-64019 NEEDLE HOLDER | 1 |  | |
| 5 | 257565000009 SPREADER | 1 |  | |
| 6 | 257566000009 LOOPER | 1 |  | |
| 7 | 259146-16F09 MAIN FEED DOG | 1 |  | |
| 8 | 259148-16F09 MAIN FEED DOG | 1 |  | |
| 9 | 259262-16F09 DIFF. FEED DOG | 1 |  | |
| 10 | 259263-16F09 DIFF. FEED DOG | 1 |  | |
| 11 | 259572000009 NEEDLE GUARD(FRONT) | 1 |  | |
| 12 | 259573-92009 NEEDLE GUARD(REAR) | 1 |  | |
| 13 | 259618B40019 NEEDLE PLATE | 1 | | |
| 14 | 259618B48019 NEEDLE PLATE | 1 |  | |

| NO. | PARTS NO. | QTY. | 360° IMAGE | INTO MYLIST |
|-----|------------------------------|------|---|-------------|
| 15 | 259619B56019 NEEDLE PLATE | 1 |  | |
| 16 | 259619B64019 NEEDLE PLATE | 1 |  | |
| 17 | 3Q0073024009 PRESSER FOOT | 1 | | |
| 18 | 3Q0073024809 PRESSER FOOT | 1 |  | |
| 19 | 3Q0073035609 PRESSER FOOT | 1 | | |
| 20 | 3Q0073036409 PRESSER FOOT | 1 |  | |

W200P ゲージパーツ系列構成図

W200P GAUGE PARTS CHART

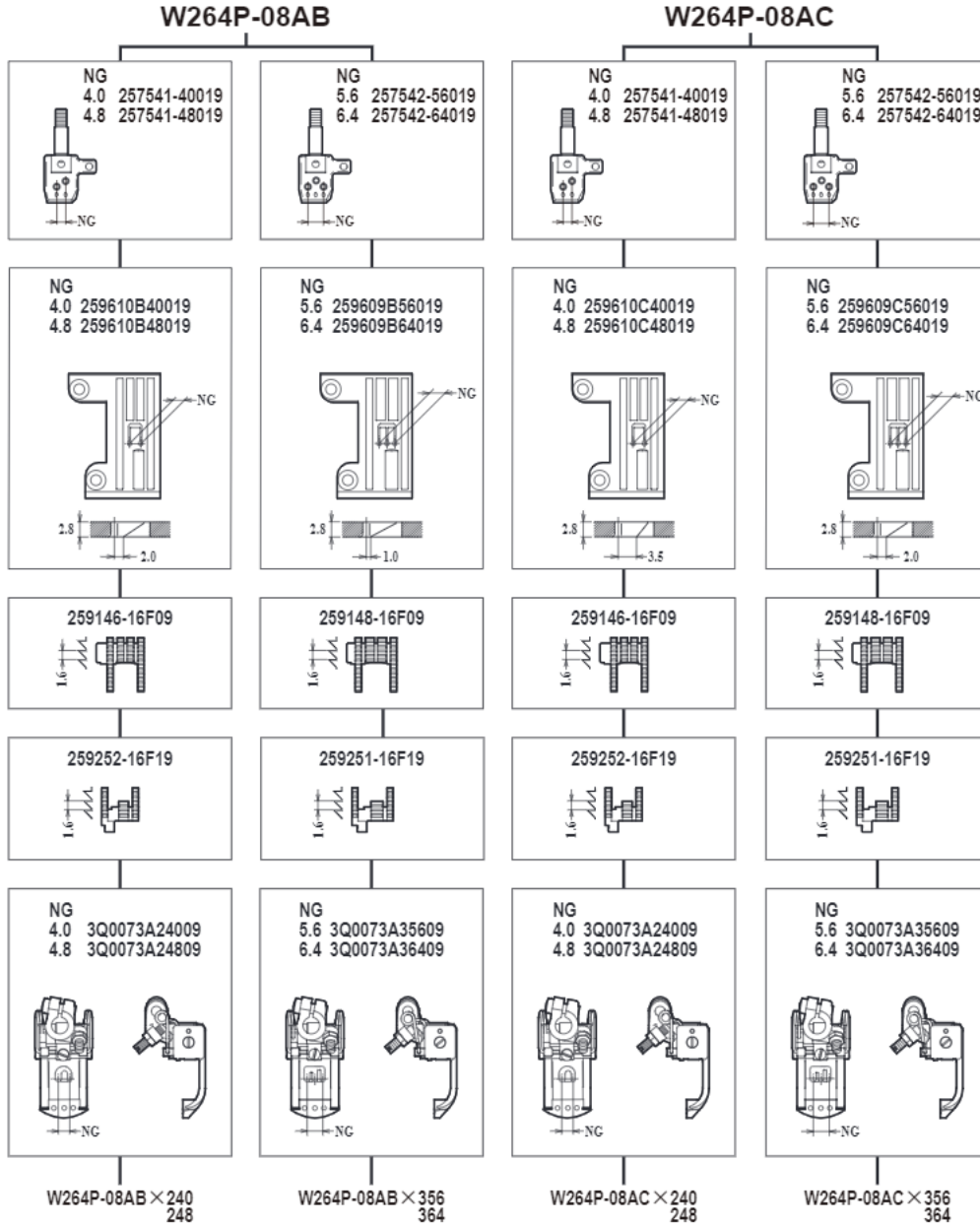











W264P-08A
 用途:裾伏せ縫い
 Application: Hemming

共通部品
 COMMON PARTS



| NO. | PARTS NO. | QTY. | 360° IMAGE | INTO MYLIST |
|-----|-------------------------------------|------|---|-------------|
| 1 | 257541-40019 NEEDLE HOLDER | 1 |  | |
| 2 | 257541-48019 NEEDLE HOLDER | 1 |  | |
| 3 | 257542-56019 NEEDLE HOLDER | 1 |  | |
| 4 | 257542-64019 NEEDLE HOLDER | 1 |  | |
| 5 | 257565000009 SPREADER | 1 |  | |
| 6 | 257566000009 LOOPER | 1 |  | |
| 7 | 259146-16F09 MAIN FEED DOG | 1 |  | |
| 8 | 259148-16F09 MAIN FEED DOG | 1 |  | |
| 9 | 259251-16F19 DIFF. FEED DOG | 1 |  | |
| 10 | 259252-16F19 DIFF. FEED DOG | 1 |  | |
| 11 | 259572000009 NEEDLE GUARD(FRONT) | 1 |  | |
| 12 | 259573-92009 NEEDLE GUARD(REAR) | 1 |  | |
| 13 | 259609B56019 NEEDLE PLATE | 1 |  | |
| 14 | 259609B64019 NEEDLE PLATE | 1 |  | |

| NO. | PARTS NO. | QTY. | 360° IMAGE | INTO MYLIST |
|-----|------------------------------|------|---|-------------|
| 15 | 259609C56019 NEEDLE PLATE | 1 |  | |
| 16 | 259609C64019 NEEDLE PLATE | 1 |  | |
| 17 | 259610B40019 NEEDLE PLATE | 1 |  | |
| 18 | 259610B48019 NEEDLE PLATE | 1 |  | |
| 19 | 259610C40019 NEEDLE PLATE | 1 |  | |
| 20 | 259610C48019 NEEDLE PLATE | 1 |  | |
| 21 | 3Q0073A24009 PRESSER FOOT | 1 |  | |
| 22 | 3Q0073A24809 PRESSER FOOT | 1 |  | |
| 23 | 3Q0073A35609 PRESSER FOOT | 1 |  | |
| 24 | 3Q0073A36409 PRESSER FOOT | 1 |  | |

W200P ゲージパーツ系列構成図

W200P GAUGE PARTS CHART

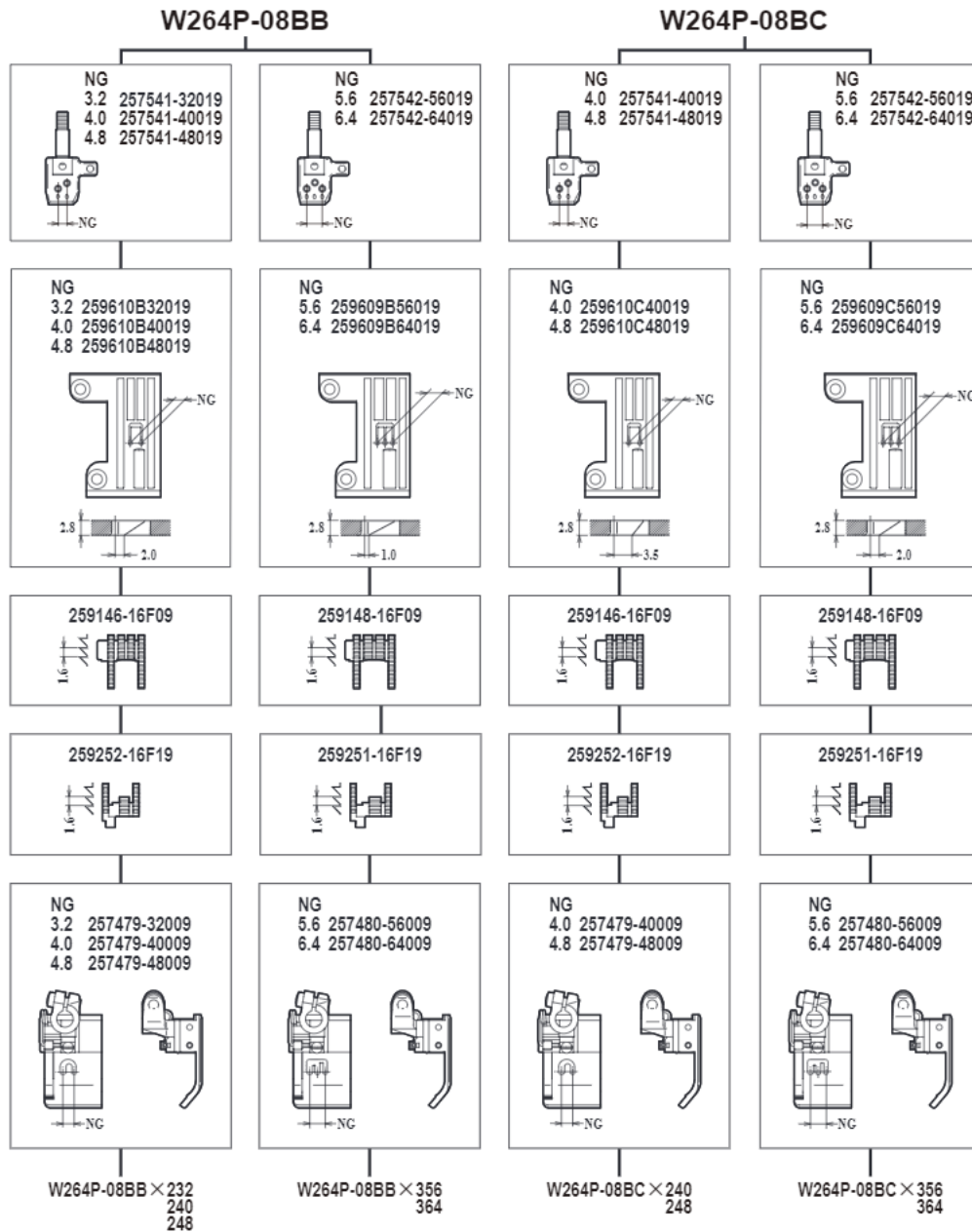























W264P-08B

用途: 裾伏せ縫い
Application: Hemming

共通部品
COMMON PARTS



| NO. | PARTS NO. | QTY. | 360° IMAGE | INTO MYLIST |
|-----|-----------------------------------|------|---|-------------|
| 1 | 257479-32009 PRESSER FOOT ASSY | 1 |  | |
| 2 | 257479-40009 PRESSER FOOT ASSY | 1 |  | |
| 3 | 257479-48009 PRESSER FOOT ASSY | 1 |  | |
| 4 | 257480-56009 PRESSER FOOT ASSY | 1 |  | |
| 5 | 257480-64009 PRESSER FOOT ASSY | 1 |  | |
| 6 | 257541-32019 NEEDLE HOLDER | 1 |  | |
| 7 | 257541-40019 NEEDLE HOLDER | 1 |  | |
| 8 | 257541-48019 NEEDLE HOLDER | 1 |  | |
| 9 | 257542-56019 NEEDLE HOLDER | 1 |  | |
| 10 | 257542-64019 NEEDLE HOLDER | 1 |  | |
| 11 | 257565000009 SPREADER | 1 |  | |
| 12 | 257566000009 LOOPER | 1 |  | |
| 13 | 259146-16F09 MAIN FEED DOG | 1 |  | |
| 14 | 259148-16F09 MAIN FEED DOG | 1 |  | |

| NO. | PARTS NO. | QTY. | 360° IMAGE | INTO MYLIST |
|-----|-------------------------------------|------|---|-------------|
| 15 | 259251-16F19 DIFF. FEED DOG | 1 |  | |
| 16 | 259252-16F19 DIFF. FEED DOG | 1 |  | |
| 17 | 259572000009 NEEDLE GUARD(FRONT) | 1 |  | |
| 18 | 259573-92009 NEEDLE GUARD(REAR) | 1 |  | |
| 19 | 259609B56019 NEEDLE PLATE | 1 |  | |
| 20 | 259609B64019 NEEDLE PLATE | 1 |  | |
| 21 | 259609C56019 NEEDLE PLATE | 1 |  | |
| 22 | 259609C64019 NEEDLE PLATE | 1 |  | |
| 23 | 259610B32019 NEEDLE PLATE | 1 |  | |
| 24 | 259610B40019 NEEDLE PLATE | 1 |  | |
| 25 | 259610B48019 NEEDLE PLATE | 1 |  | |
| 26 | 259610C40019 NEEDLE PLATE | 1 |  | |
| 27 | 259610C48019 NEEDLE PLATE | 1 |  | |

<< >>

W264P-08MC

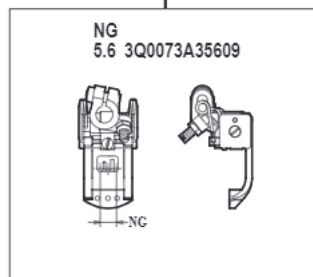
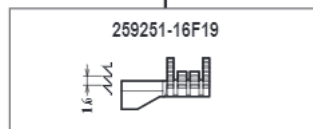
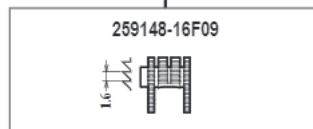
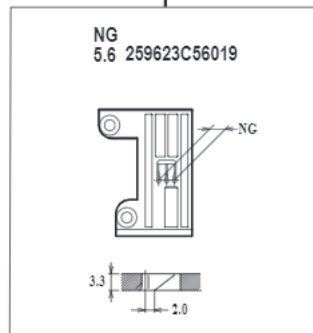
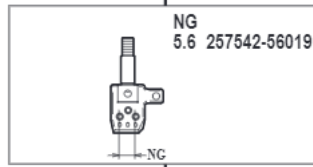



W264P-08MC × 356

W264P-08MC

用途: 裾伏せ縫い
Application: Hemming

共通部品
COMMON PARTS

| | | | |
|--------------|--------------|--------------|--------------|
| 257566000009 | 259572000009 | 259573-92009 | 257565000009 |
| | | | |

| NO. | PARTS NO. | QTY. | 360° IMAGE | INTO MYLIST |
|-----|-------------------------------------|------|---|-------------|
| 1 | 257542-56019 NEEDLE HOLDER | 1 |  | |
| 2 | 257565000009 SPREADER | 1 |  | |
| 3 | 257566000009 LOOPER | 1 |  | |
| 4 | 259148-16F09 MAIN FEED DOG | 1 |  | |
| 5 | 259251-16F19 DIFF. FEED DOG | 1 |  | |
| 6 | 259572000009 NEEDLE GUARD(FRONT) | 1 |  | |
| 7 | 259573-92009 NEEDLE GUARD(REAR) | 1 |  | |
| 8 | 259623C56019 NEEDLE PLATE | 1 |  | |
| 9 | 3Q0073A35609 PRESSER FOOT | 1 |  | |

W200P ゲージパーツ系列構成図

W200P GAUGE PARTS CHART

W264P-35BB







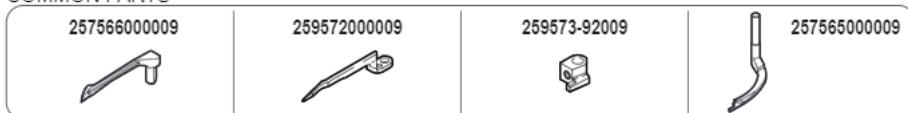

W264P-35NB







W264P-35B,N
用途:裾伏せ縫い
Application:Hemming

共通部品
COMMON PARTS



| NO. | PARTS NO. | QTY. | 360° IMAGE | INTO MYLIST |
|-----|-------------------------------------|------|---|-------------|
| 1 | 257541-48019 NEEDLE HOLDER | 1 |  | |
| 2 | 257542-56019 NEEDLE HOLDER | 1 |  | |
| 3 | 257542-64019 NEEDLE HOLDER | 1 |  | |
| 4 | 257565000009 SPREADER | 1 |  | |
| 5 | 257566000009 LOOPER | 1 |  | |
| 6 | 259572000009 NEEDLE GUARD(FRONT) | 1 |  | |
| 7 | 259573-92009 NEEDLE GUARD(REAR) | 1 |  | |
| 8 | 2Q0011B24819 NEEDLE PLATE | 1 | | |
| 9 | 2Q0013B35619 NEEDLE PLATE | 1 |  | |
| 10 | 2Q0013B36409 NEEDLE PLATE | 1 |  | |
| 11 | 2Q0019B24809 NEEDLE PLATE | 1 | | |
| 12 | 2Q0020B35609 NEEDLE PLATE | 1 |  | |
| 13 | 3B0007016F09 MAIN FEED DOG | 1 |  | |
| 14 | 3B0008016F09 MAIN FEED DOG | 1 |  | |

| NO. | PARTS NO. | QTY. | 360° IMAGE | INTO MYLIST |
|-----|--------------------------------|------|---|-------------|
| 15 | 3G0010016F09 DIFF. FEED DOG | 1 |  | |
| 16 | 3G0011016F09 DIFF. FEED DOG | 1 |  | |
| 17 | 3Q0038024809 PRESSER FOOT | 1 |  | |
| 18 | 3Q0039035609 PRESSER FOOT | 1 |  | |
| 19 | 3Q0039036409 PRESSER FOOT | 1 |  | |

ペガサスミシン製造株式会社

本社 〒 553-0002 大阪市福島区鷺洲 5-7-2 TEL (06)6458-4739
FAX (06)6454-8785

PEGASUS SEWING MACHINE MFG. CO., LTD.

5-7-2, Sagisu, Fukushima-ku, Osaka 553-0002, Japan. Phone : (06)6458-4739
Telefax: (06)6454-8785

Cat. No. 973900000029 April 2020

© 1996 PEGASUS SEWING MACHINE MFG. CO., LTD.

このパーツカタログに記載されている内容は、改良のため予告なく変更することがあります。
The description in this PARTS CATALOG is subject to change without prior notice.

