

# **LOIVA<sup>®</sup>**

## **USER MANUAL & PARTS LIST**

단추 공급기

**BUTTON FEEDER MACHINE**

**ST-12**





- 최고의 품질! Easy to operate!
- 간단한 방식! Tight knotting!
  - 원활한 공급! Best feeder!

*포기없는 추진력... Do our best for you...*

*최선을 다하는 로이바... We, LOIVA COMPANY.*

저희 로이바는 수 많은 봉제 현장의 문제점을 정확히 파악하고 효율적인 생산을 위해 봉제현장의 오랜 경험을 가진 기술진들과 국내 최고의 기계들로 새 바람을 일으켜 왔습니다.

보이지 않는 부품 하나에도 정성을 다하며 정확한 공정과 제품관리로 폐사에서 생산되는 단추뿌리감기 기계, 포기 없는 추진력과 철저한 장인정신으로 최선을 다해 제조되는 로이바의 제품인 단추 공급기를 자신 있게 권해 드리며 제품의 원활한 공급과 완벽한 A/S 로 소비자의 관심에 보답하고 항상 발전하는 로이바가 되겠습니다.

먼저 단추 공급기를 구입하여 주셔서 감사 드립니다. 사용 설명서 대로 사용하시면 최고의 품질을 생산할 수 있습니다.

Our LOIVA has correctly found out numerous problems happening in the field. For an effective production, we have blown a new trend into the sewing-machine industry by the exclusive development without imitation in cooperation with engineers having longtime experience at the sewing field and the domestic machine development team.

With our full attention to an invisible part, correct process lining and quality control, the button feeder machine, we confidently recommend our products manufactured with the best efforts in ceaseless thrust and thoroughgoing craftsmanship.

We, LOIVA will be a developing company constantly and repay the consumer's attention with fluent supply of products and perfect service after sales.

We thank you for purchasing our button feeder machine ST-12. Please read following the manual before using the machine for best quality.

1) 사양(Specifications)

- 면적(장/폭/고) (Dimension) : 550 X 430 X 370 mm
- 무게(Weight) : 45kg
- 에어 소비량(Air consumption) : 0.32 l/Min
- 에어 압력(Air pressure) : 5~6 kg/cm<sup>2</sup>
- 전원볼트(Power) : Free voltage 100V~240V
- 사이클(Cycle) : Free Cycle 50/60Hz

2) 주요사항(Important notes)

문제나 손실을 피하기 위해서는 아래의 사용설명서를 관찰하는 것이 절대적으로 필요합니다. (To avoid trouble or damage it is absolutely necessary to observe the following instructions).

- 기계를 시행하기 이전에 우선 완전히 청소를 하고 혹시 기계에 먼지가 있으면 먼지도 제거해야 합니다. (Before you put the machine into operation for the first time clean it thoroughly, remove all dust which has accumulated on it.)
- 모터가 나타내는 전압과 전압을 확인하시기 바랍니다. 만일 그렇지 않으면 플러그를 기계에 꽂지 말아야 합니다. (Check to make sure line voltage agrees with the voltage indicated on the motor rating plate. If it is does not, be sure not to plug in the machine.)
- 정확한 압력을 체크해야 합니다. (Check you have the correct pneumatic line pressure.)

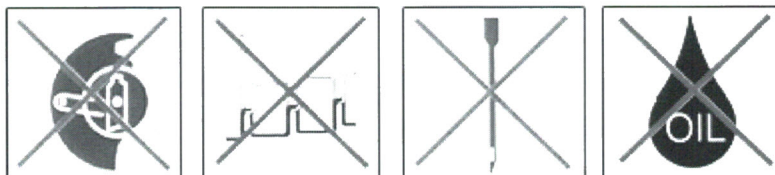

### 3) 안전 교육(Safety instructions)



was designed for. In safety instructions



devices it is equipped



All guards must be in position before starting



Do not operate this equipment unless technically qualified by person who



Unauthorised Persons not to use this machine.



This machine must not be dismantled or cleaned unless it has been switched off and unplugged



CAUTION Risk of Electric shock

maintenance work the actuating the master switch

engaged or the



pneumatic devices pneumatic supply source

- 본 기계를 설계상의 목적 외 타 용도로 사용하지 말아야 합니다. 기계가 다른 버전으로 변환된 경우에는 가능한 모든 안전교육을 깊이 고려해야 합니다.

The machine must only be used for the purpose it was designed for. In case of conversion into another version all valid safety instructions have to be considered.

- 안전장치가 갖추어져 있지 않다면 이 기계를 작동 하지 말아야 합니다.

Do not operate this machine without the safety devices it is equipped with.

- 그러므로 기계는 교육을 받은 사람만이 작동 및 관리하여야 합니다.

The machine must only be switched on and operated by persons who have been instructed accordingly.

- 부품 교환이나 정비 작업은 주 스위치가 끊어진 상태이거나 메인 플러그가 제거된 상태에서 이루어져야 합니다.

When exchanging parts and when doing maintenance work the machine must be disconnected either by actuating the master switch or by removing the mains plug.

- 기계의 비상시(이상시) 연동하거나 스위치를 꺼야 합니다. When threading machine Emergency Stop must be engaged or the machine switched off.

- 압축공기 장치를 보존하거나 수리할 때는 기계를 공기제공의 근원이 끊어진 상태에서 이행여야 합니다.

When carrying out maintenance or repair work on pneumatic devices the machine must be disconnected from the pneumatic supply source.

- 그러므로 이 기계의 전기장치 일을 할 때는 전기 담당자나 그에 알맞은 교육을 받은 사람이 이행해야 합니다. Work on electrical equipment on this machine must only be carried out by electricians or other persons who have instructed accordingly.

## ST-12 BUTTON FEEDER MACHINE

콘트롤러 전원을 키면 원점복귀 후 작업대기.

When you turn on the switch, ready the working after return the starting point.

4개의 페이지로 구성되어 있고 “•”키를 누르면 페이지 전환을 하며, 정상시는 “WORK”과 “JOG”페이지만 보여주고 “0”또는 “•”키를 누르고 전원을 키면 모든 페이지를 보여줍니다.

Please press the “•”key if you want other page. Normal pages are the “WORK” and “JOG”. But when you turn on the switch, show the all pages status pressing the “0” or “•”key. Total 4 pages, “WORK”, “JOG”, “STATUS”, “SETTING”.

“0”키를 누르고 전원을 키면 모든 데이터가 초기화되면서 원점복귀를 하지 않고 모든 페이지를 보여주고, “•”키를 누르고 전원을 키면 데이터를 초기화만 하지 않고 동일 기능을 수행합니다.

When turn on the switch, status pressing the “0”key, become a initialization, but do not return the starting point. When turn on the switch, status pressing the “•”key, do not become a initialization.

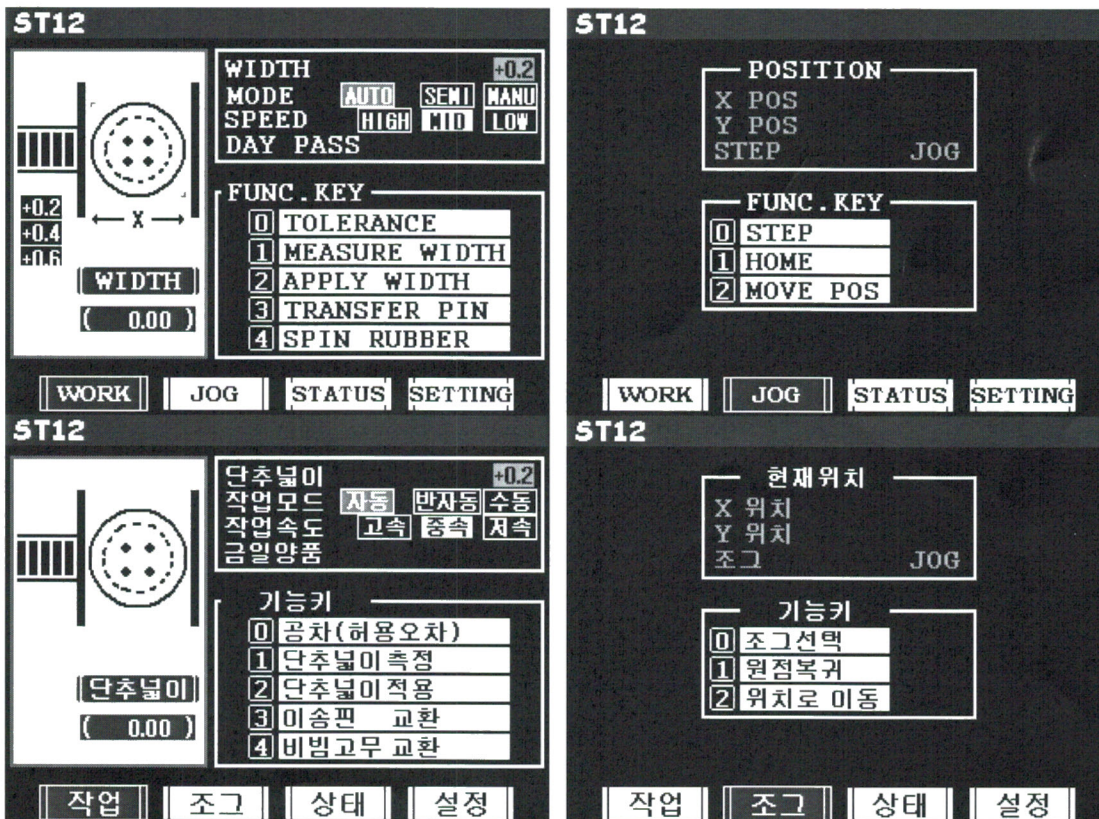

“1”키를 누르고 전원을 키면 사용하는 언어가 영어나 한국어로 선택됩니다.

Langue selection is the “1”key. When turn on the switch, status pressing the “1”key, change the langue.

사용법(Usage)

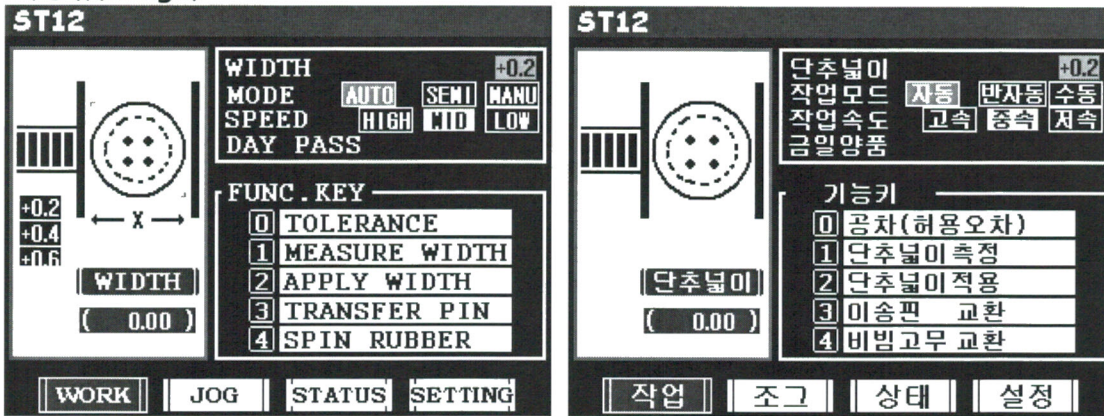

- 작업모드(working mode)

◀/▶ 키를 눌러서 모드를 변경하며 자동모드는 진동기를 사용하여 단추를 정렬하여 미싱신호에 의해서 단추를 공급하고, 반자동모드는 미싱신호가 들어와도 단추를 공급하지 않고 BUTTON SUPPLY S/W(수동공급 스위치)가 눌러 질 때만 단추를 공급.

수동모드는 진동기와 공급기를 사용하지 않고 손으로 미싱에 단추를 공급하는 모드.

You can change the mode using the ◀/▶ key, automatic mode arrange the button by vibration device, feeding by sewing machine signal. Semi automatic mode do not feed the button, need the pressing the switch. Handling mode is the feeding button by the hand.

자동모드에서 미싱신호에 의해서 공급을 하면 금일양품 수량이 증가하고,

BUTTON SUPPLY S/W(수동공급 스위치)에 의해서 공급을 하면 금일불량 수량이 증가.

Automatic mode – increasing today production

Using the button supply switch – increasing the faulty production

▲/▼ 키를 누르면 작업속도가 변경.

You can control working speed by using ▲/▼ key.

※ “.” 키를 눌러서 페이지 변경할 때 자동모드 사용하고 있다면 진동기를 off하고 약 7초간의 지연시간이 발생됨.

When you change the page, using the automatic mode, happen the delay time about 7sec after turning off the vibration device.

- 단추넓이 설정 (수동) adjust the button width(handling)

대기상태에서 “E”키를 누르고 ▲/▼를 눌러 WIDTH 항목에서 단추넓이 값을 변경 후 “E”키를 눌러 저장. (값을 변경해도 바로 적용되지는 않음.)

Press the “E” key in status waiting → change the button width → press the “E” become a saving

- 단추넓이 설정 (자동) **adjust the button width(automatic)**

측정기가 비워져 있는지 확인 후 “1”키를 눌러서 측정모드로 진입 후 단추를 측정기에 넣고, “2”키를 누르면 자동으로 원점복귀하고 이송로의 단추들을 제거하고,

다시 “2” 키를 누르면 측정한 값으로 단추의 이송로가 변경됨.

※ 자동모드 사용시 진동기를 off하고 약 7초간의 지연시간이 발생됨.

check the there are noting in a measuring instrument → press the press the “1”key → put in the button in a measuring instrument → When you press the “2”key, automatic return starting point and remove the button on moving button road → press the “2”key all change

※ When you use the automatic mode, happen the delay time about 7sec after turning off the vibration device.

- 이송핀 교환(exchange the supply pin)

“3”키를 누르면 이송핀 교환 위치로 이동하고, 교환 후 “3”키를 누르면 복귀함.

※ 자동모드 사용시 진동기를 off하고 약 7초간의 지연시간이 발생됨.

When press the “3”key, supply pin move a exchange location. Press “3”key return after exchange.

※ When you use the automatic mode, happen the delay time about 7sec after turning off the vibration device.

- 비빔고무 교환( exchange the spinning robber)

“4”키를 누르면 교환 위치로 이동하고, “4”키를 누르면 비빔대가 회전하고 교환 후

“4”키를 누르면 복귀함.

※ 자동모드 사용시 진동기를 off하고 약 7초간의 지연시간이 발생됨.

Press “4”key, move to the exchange location → press “4”key, spinning load turn round → exchange the spinning robber → press “4”key, return

※ When you use the automatic mode, happen the delay time about 7sec after turning off the vibration device.

- 공급기의 불량단추 제거. Remove the faulty button

“C”키를 누르면 공급기 내부가 열리고, 불량단추를 제거 후 “C” 키를 누르면 원래의 상태로 복귀.

Press the “C”key, open the inside → press the “C”key, become a status origin after remove the faulty button

- 작업수량 확인 및 삭제 ( check the working count and delete)

press“1”key about 2sec – expression DAY PASS (delete is “C”key about 2sec)

press“2”key about 2sec – expression DAY REJECT (delete is “C”key about 2sec)

press“3”key about 2sec – expression SUM PASS (delete is “C”key about 2sec)

press“4”key about 2sec – expression SUM REJECT (delete is “C”key about 2sec)

**키 설명(function key)**

특수키(special key) : NEED THE POWER OFF/ON

0	데이터 초기화 DATA INITIALIZATION
1	언어 선택 (한글/영어) CHANGE THE LANGUAGE (KOREAN/ENGLISH)
•	테스트모드 TEST MODE

**작업 페이지(WORK PAGE)**

•	페이지 변경(CHANGE THE PAGE)
◀/▶	작업모드 WORKING MODE : (AUTOMATIC/SEMI/MANU)
▲/▼	작업속도 WORKING SPEED : (HIGH/MID/LOW)
E	편집과 저장EDITE AND SAVE : BUTTON WIDTH(MANU), AUTOMATIC TIME
0	단추의 공차를 설정.
1	단추넓이 측정. MEASURING THE BUTTON WIDTH
2	단추넓이 조절 CONTROL BUTTON WIDTH (EXCHAGNE)
3	이송핀 교환 EXCHANGE BUTTON SUPPLY PIN
4	비빔고무 교환 EXCHANGE SPINNING ROBBER
C	공급기의 불량단추 제거 REMOVE THE FAULTY BUTTON
1 (2sec)	금일 양품 EXPRESSION 'DAY PASS' (DELETE -"C"KEY 2SEC )
2 (2sec)	금일 불량 EXPRESSION 'DAY REJECT'(DELETE -"C"KEY 2SEC )
3 (2sec)	누적 양품 EXPRESSION 'SUM PASS' (DELETE -"C"KEY 2SEC )
4 (2sec)	누적 불량 EXPRESSION 'SUM REJECT'(DELETE -"C"KEY 2SEC )

**조그 페이지(JOG PAGE)**

•	페이지 변경 CHANGE THE PAGE
0	조그 선택 SELLECTION JOG
1	시작점 복귀 RETURN STARTING POINT
2	회전이동 MOVING THE LOCATION
◀/▶	X축 AXIS 'X'
▲/▼	Y축 AXIS 'Y'



**AUTOMATIC CONTROL THE BUTTON SIZER  
ASS'Y PART LIST**

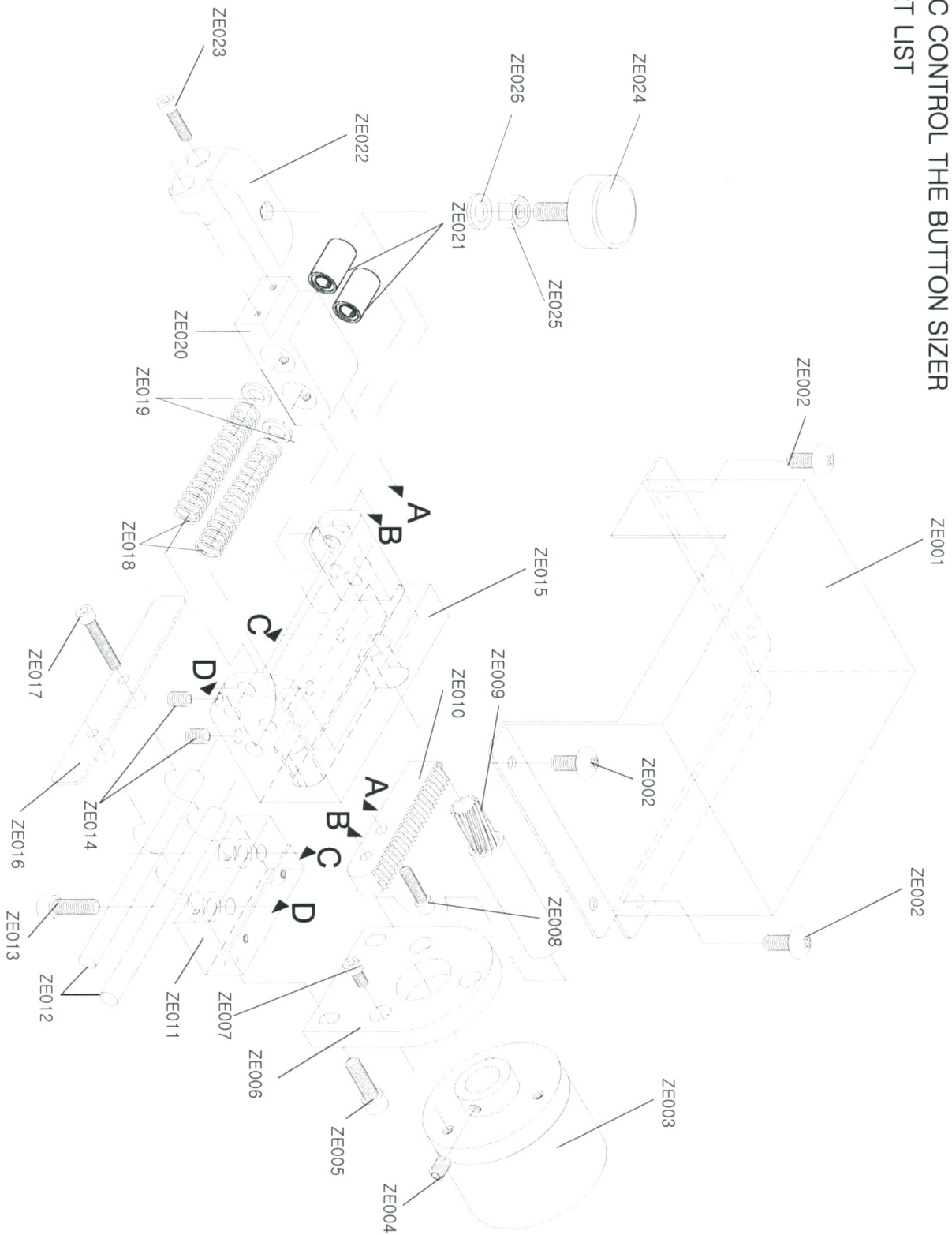

No.	Part No.	Part Name
1	ZE001	SYNCRONIZER COVER
2	ZE002	TRUS FIXING BOLT
3	ZE003	SYNCRONIZER
4	ZE004	HEADNESS FIXING BOLT
5	ZE005	ALLEN FIXING BOLT
6	ZE006	SYNCRONIZER BRACKET
7	ZE007	ALLEN FIXING BOLT
8	ZE008	ALLEN FIXING BOLT
9	ZE009	SYNCRONIZER GEAR
10	ZE010	BUTTON SIZER FLAT GEAR
11	ZE011	SYNCRONIZER HOLDER
12	ZE012	BUTTON SIZER ROD
13	ZE013	ALLEN FIXING BOLT
14	ZE014	HEADNESS FIXING BOLT
15	ZE015	BUTTON SIZER TRAY
16	ZE016	COVER
17	ZE017	ALLEN FIXING BOLT
18	ZE018	BUTTON SIZER SPRING
19	ZE019	WASHER
20	ZE020	BUSHING HOLDER
21	ZE021	BUSHING BEARING
22	ZE022	SIZE MEASUREMENT
23	ZE023	ALLEN FIXING BOLT
24	ZE024	HANDLE
25	ZE025	NUT
26	ZE026	WASHER
27		
28		
29		
30		
31		
32		
33		
34		
35		
36		
37		

No.	Part No.	Part Name
38		
39		
40		
41		
42		
43		
44		
45		
46		
47		
48		
49		
50		
51		
52		
53		
54		
55		
56		
57		
58		
59		
60		
61		
62		
63		
64		
65		
66		
67		
68		
69		
70		
71		
72		
73		
74		

**SPINNING & TRANSFER DEVICE ASS'Y PART LIST**

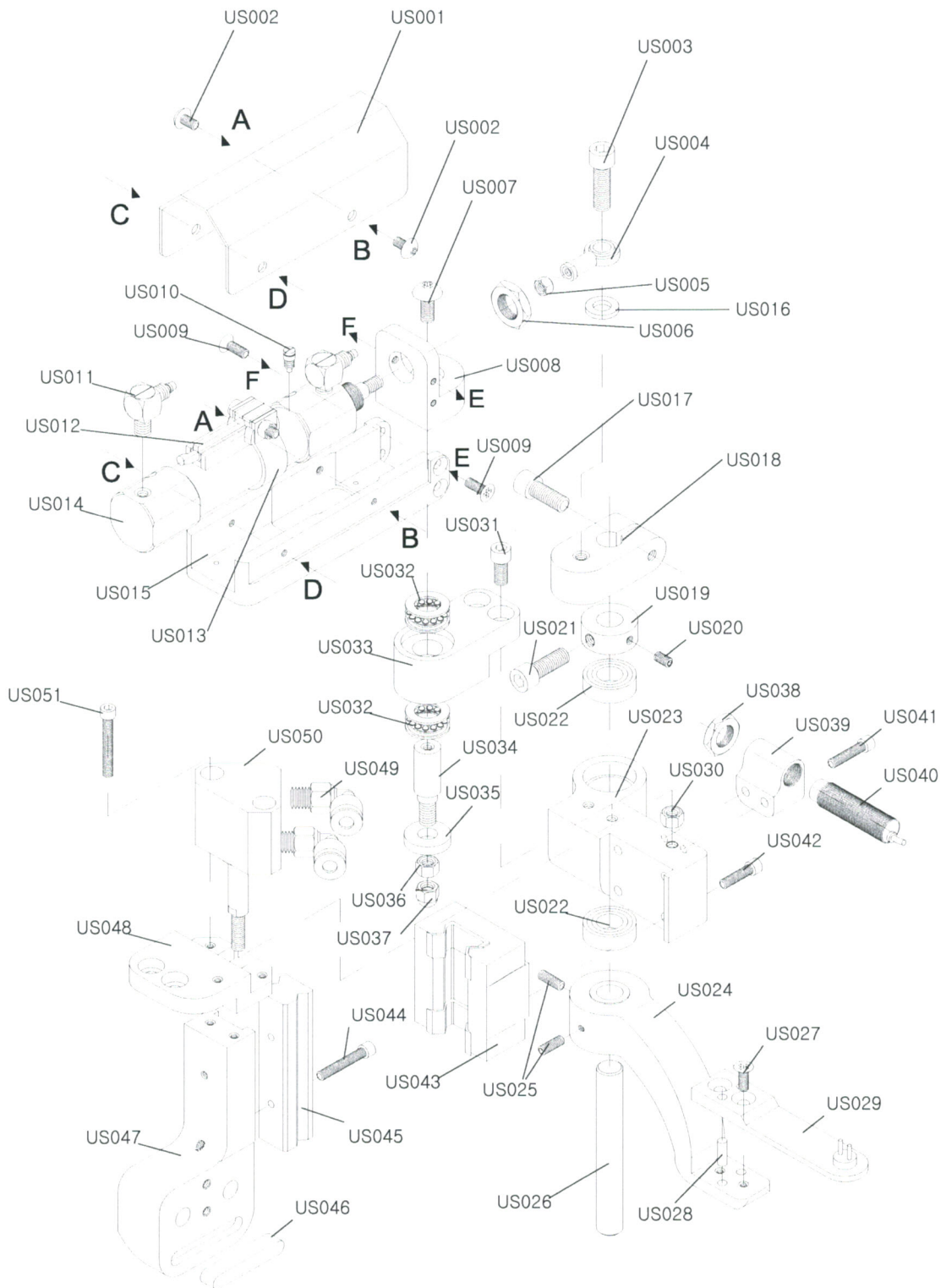



## THE RUNWAY OF BUTTON ASS'Y PART LIST

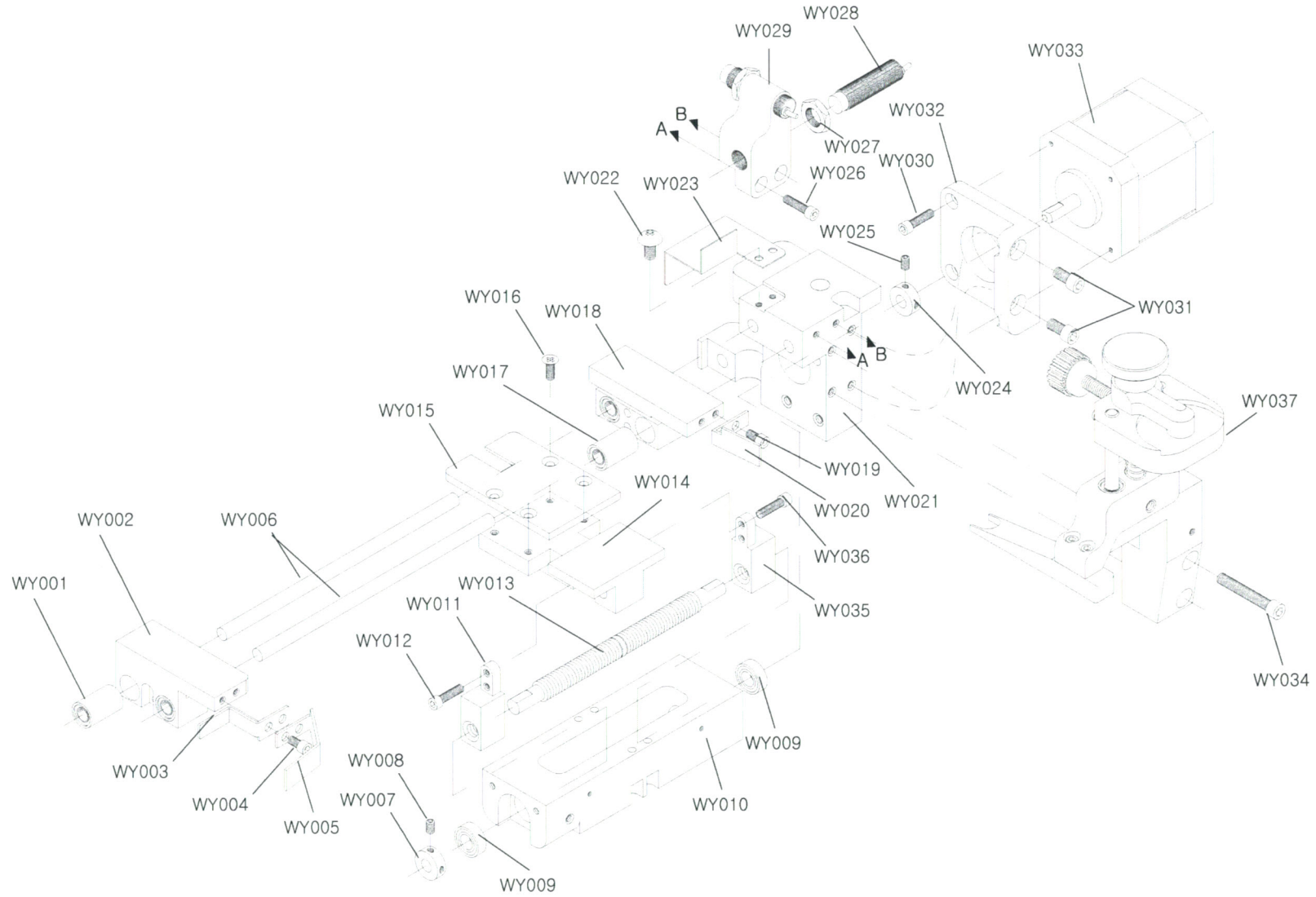

No.	Part No.	Part Name
1	WY001	BUSHING BEARING
2	WY002	BEARING HOLDER
3	WY003	BUTTON GUIDE
4	WY004	ALLEN FIXING BOLT
5	WY005	BUTTON GUIDE
6	WY006	ROD
7	WY007	RING
8	WY008	HEADNESS FIXING BOLT
9	WY009	BEARING
10	WY010	GEAR BOX
11	WY011	BUTTON SIZER NUT
12	WY012	ALLEN FIXING BOLT
13	WY013	GEAR
14	WY014	FLAT HOLDER
15	WY015	FLAT
16	WY016	FLAT FIXING BOLT
17	WY017	BUSHING BEARING
18	WY018	BEARING HOLDER
19	WY019	ALLEN FIXING BOLT
20	WY020	BUTTON GUIDE
21	WY021	PILLAR
22	WY022	TRUS FIXING BOLT
23	WY023	COVER
24	WY024	RING
25	WY025	HEADNESS FIXING BOLT
26	WY026	ALLEN FIXING BOLT
27	WY027	SENSOR NUT
28	WY028	SENSOR
29	WY029	HOLDER (EXCEPT SENSOR)
30	WY030	ALLEN FIXING BOLT
31	WY031	ALLEN FIXING BOLT
32	WY032	MOTOR HOLDER
33	WY033	MOTOR
34	WY034	ALLEN FIXING BOLT
35	WY035	BUTTON SIZER NUT
36	WY036	ALLEN FIXING BOLT
37	WY037	COVER

No.	Part No.	Part Name
38		
39		
40		
41		
42		
43		
44		
45		
46		
47		
48		
49		
50		
51		
52		
53		
54		
55		
56		
57		
58		
59		
60		
61		
62		
63		
64		
65		
66		
67		
68		
69		
70		
71		
72		
73		
74		

STANDBY THE BUTTON ASS'Y PART LIST

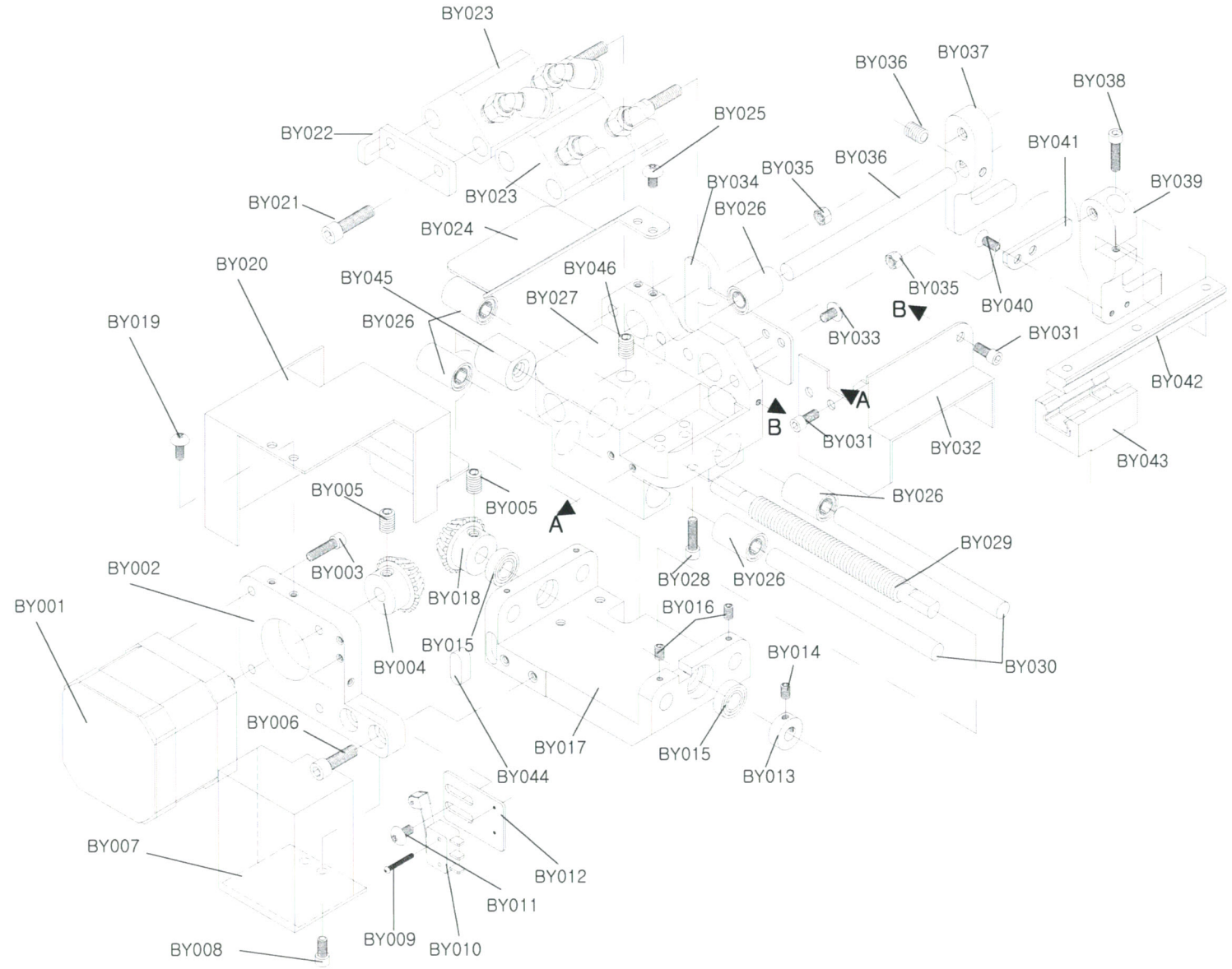

No.	Part No.	Part Name
1	BY001	MOTOR
2	BY002	MOTOR HOLDER
3	BY003	ALLEN FIXING BOLT
4	BY004	GEAR
5	BY005	HEADNESS FIXING BOLT
6	BY006	ALLEN FIXING BOLT
7	BY007	COVER
8	BY008	ALLEN FIXING BOLT
9	BY009	SWITCH HOLDING BOLT
10	BY010	SWITCH
11	BY011	TRUS FIXING BOLT
12	BY012	SWITCH BRACKET
13	BY013	RING
14	BY014	HEADNESS FIXING BOLT
15	BY015	BEARING
16	BY016	HEADNESS FIXING BOLT
17	BY017	MOVING GEAR HOLDER
18	BY018	GEAR
19	BY019	TRUS FIXING BOLT
20	BY020	COVER
21	BY021	ALLEN FIXING BOLT
22	BY022	CYLINDER HOLDER
23	BY023	CYLINDER
24	BY024	COVER
25	BY025	TRUX FIXING BOLT
26	BY026	BUSHING BEARING
27	BY027	TWIN CYLINDER HOLDER
28	BY028	ALLEN FIXING BOLT
29	BY029	GEAR
30	BY030	SHAFT
31	BY031	ALLEN FIXING BOLT
32	BY032	COVER
33	BY033	TRUS FIXING BOLT
34	BY034	COVER
35	BY035	NUT
36	BY036	SHAFT
37	BY037	FIRST BUTTON GATE

No.	Part No.	Part Name
38	BY038	ALLEN FIXING BOLT
39	BY039	LAST BUTTON GATE
40	BY040	FLAT FIXING BOLT
41	BY041	BUTTON GATE PROTECTOR
42	BY042	RAIL
43	BY043	RAIL BLOCK
44		
45		
46		
47		
48		
49		
50		
51		
52		
53		
54		
55		
56		
57		
58		
59		
60		
61		
62		
63		
64		
65		
66		
67		
68		
69		
70		
71		
72		
73		
74		

AUTOMATIC CONTROL THE BUTTON  
THICKNESS ASS'Y PART LIST

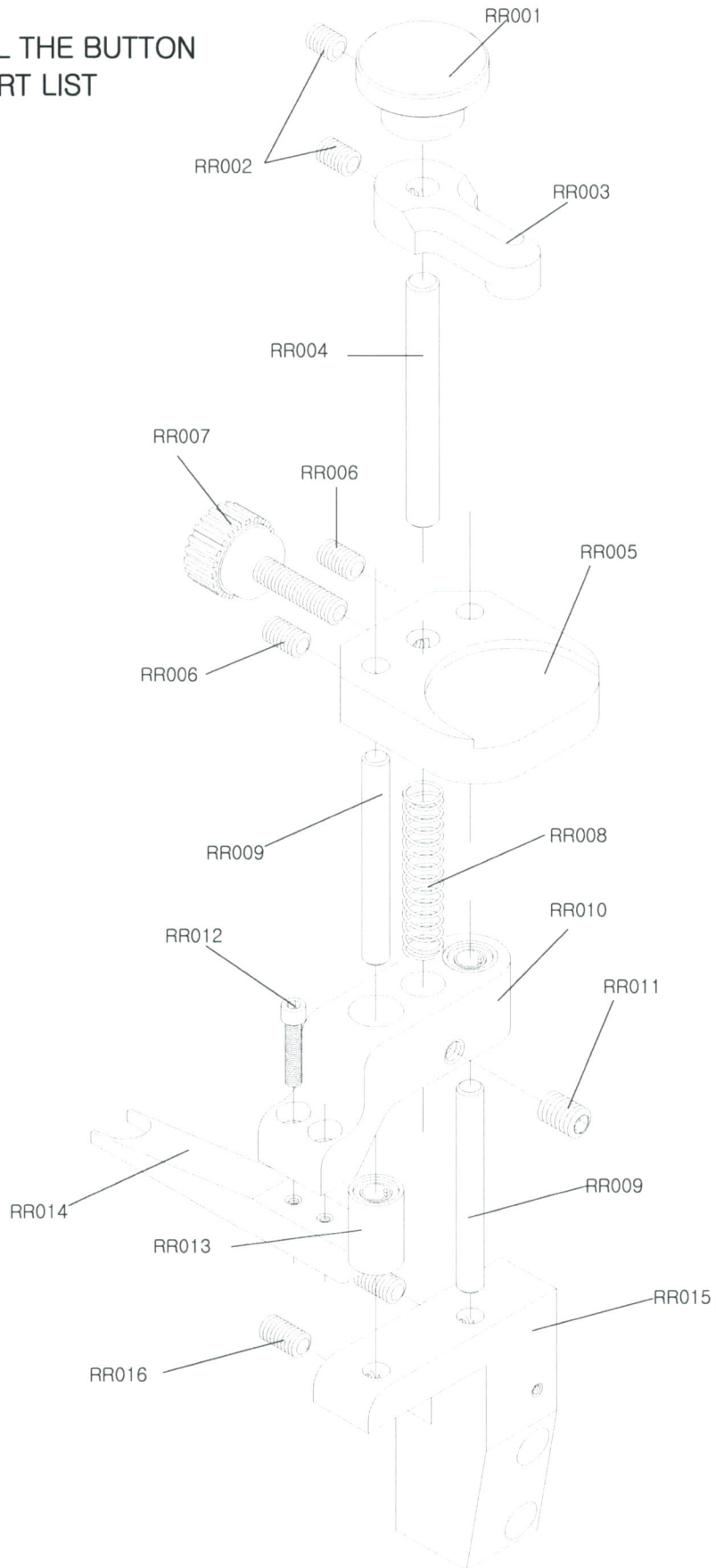

No.	Part No.	Part Name
1	RR001	GRIP
2	RR002	HEADNESS FIXING BOLT
3	RR003	BUTTON THICKNESS SIZER
4	RR004	SHAFT
5	RR005	BUTTON TRAY
6	RR006	HEADNESS FIXING BOLT
7	RR007	HANDLE BOLT
8	RR008	SPRING
9	RR009	SHAFT
10	RR010	BUTTON GUIDE HOLDER
11	RR011	HEADNESS FIXING BOLT
12	RR012	ALLEN FIXING BOLT
13	RR013	BUSHING BEARING
14	RR014	BUTTON THICKNESS GUIDE
15	RR015	THICKNESS ASS'Y HOLDER
16	RR016	HEADNESS FIXING BOLT
17		
18		
19		
20		
21		
22		
23		
24		
25		
26		
27		
28		
29		
30		
31		
32		
33		
34		
35		
36		
37		

No.	Part No.	Part Name
38		
39		
40		
41		
42		
43		
44		
45		
46		
47		
48		
49		
50		
51		
52		
53		
54		
55		
56		
57		
58		
59		
60		
61		
62		
63		
64		
65		
66		
67		
68		
69		
70		
71		
72		
73		
74		

THE BODY ASS'Y PART LIST

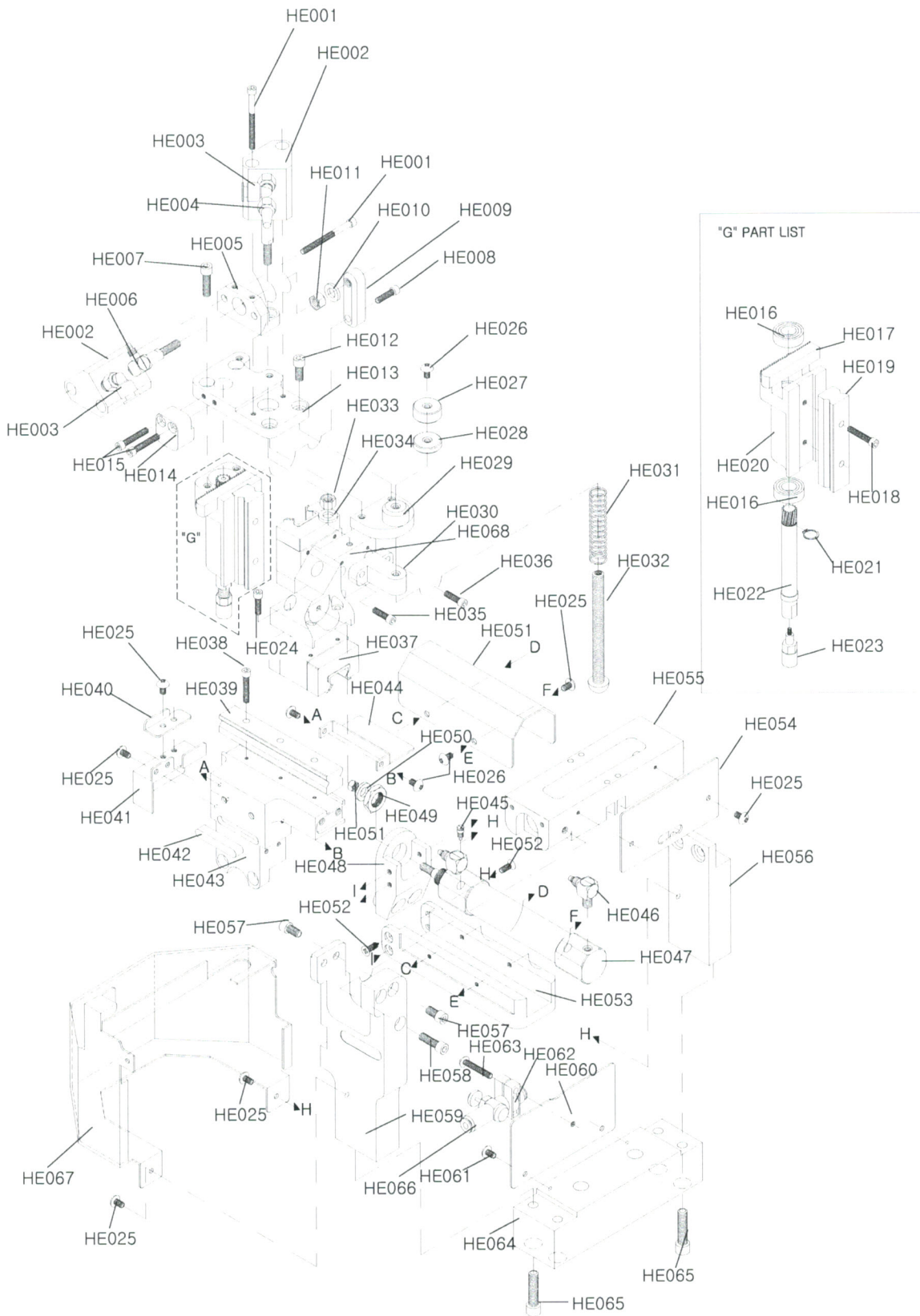

No.	Part No.	Part Name
1	HE001	ALLEN FIXING BOLT
2	HE002	CYLINDER
3	HE003	AIR NIPPLE
4	HE004	AIR SILENCER
5	HE005	CYLINDER HOLDER
6	HE006	TWO TOUCH NIPPLE
7	HE007	ALLEN FIXING BOLT
8	HE008	ALLEN FIXING BOLT
9	HE009	HOLDER
10	HE010	WASHER
11	HE011	NUT
12	HE012	ALLEN FIXING BOLT
13	HE013	SPINNING DEVICE HOLDER
14	HE014	HOLDER
15	HE015	ALLEN FIXING BOLT
16	HE016	BEARING
17	HE017	FLAT GEAR
18	HE018	ALLEN FIXING BOLT
19	HE019	RAIL
20	HE020	RAIL BLOCK
21	HE021	SNAP RING
22	HE022	SHAFT GEAR
23	HE023	SPINNING RUBBER
24	HE024	ALLEN FIXING BOLT
25	HE025	TRUS FIXING BOLT
26	HE026	TRUS FIXING BOLT
27	HE027	HANDLE NUT
28	HE028	TENSION CONTROL NUT
29	HE029	TENSION BRACKET
30	HE030	HOLDER
31	HE031	SPRING
32	HE032	SHAFT BOLT
33	HE033	NUT
34	HE034	WASHER
35	HE035	ALLEN FIXING BOLT
36	HE036	ALLEN FIXING BOLT
37	HE037	RAIL BLOCK

No.	Part No.	Part Name
38	HE038	ALLEN FIXING BOLT
39	HE039	RAIL
40	HE040	COVER
41	HE041	COVER
42	HE042	MOMO KEY
43	HE043	RAIL HOLDER
44	HE044	COVER
45	HE045	AIR CUSHION CONTROLER
46	HE046	TWO TOUCH NIPPLE
47	HE047	CYLINDER
48	HE048	CYLINDER HOLDER
49	HE049	NUT
50	HE050	WASHER
51	HE051	NUT
52	HE052	FLAT FIXING BOLT
53	HE053	CYLINDER CRADLE
54	HE054	PLATE COVER
55	HE055	GEAR BOX
56	HE056	HOLDER
57	HE057	ALLEN FIXING BOLT
58	HE058	ALLEN FIXING BOLT
59	HE059	PILLAR OF BODY
60	HE060	PLATE COVER
61	HE061	TRUS FIXING BOLT
62	HE062	SPEED CONTROLER HOLDER
63	HE063	HOLDER FIXING BOLT
64	HE064	BODY SUPPORT
65	HE065	ALLEN FIXING BOLT
66	HE066	SPEED CONTROLER
67	HE067	COVER
68	HE068	RAIL BLOCK HOLDER
69		
70		
71		
72		
73		
74		

**AUTOMATIC CONTROL THE BUTTON  
CENTER ASS'Y PART LIST**

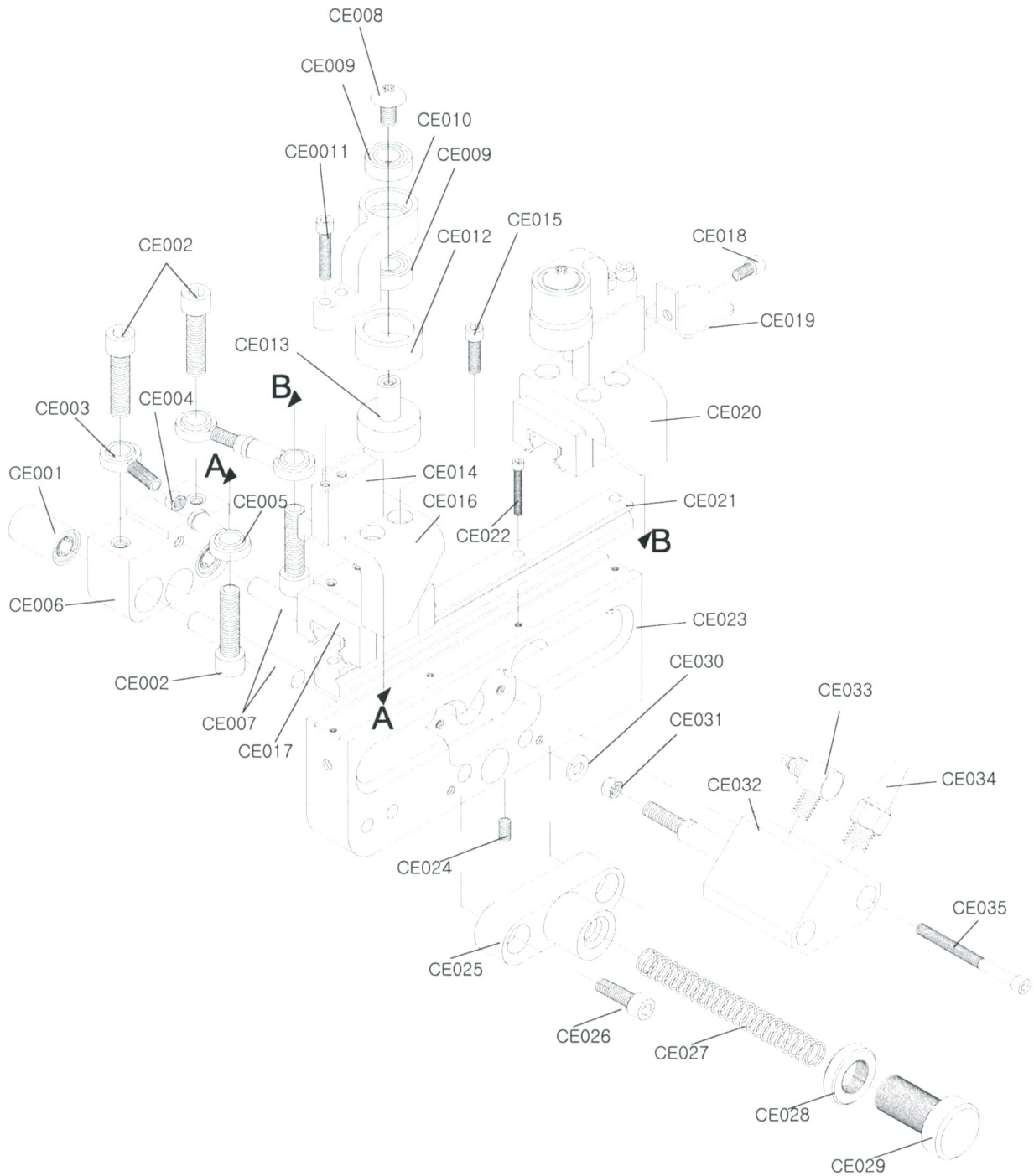

No.	Part No.	Part Name
1	CE001	BUSHING BEARING
2	CE002	ALLEN FIXING BOLT
3	CE003	ROD BEARING BOLT
4	CE004	NUT
5	CE005	ROD BEARING
6	CE006	BUSHING BEARING HOLDER
7	CE007	SHAFT
8	CE008	RAIL BLOCK
9	CE009	TRUS FIXING BOLT
10	CE010	AUTOMATIC SIZER HOLDER
11	CE011	ALLEN FIXING BOLT
12	CE012	RUBBER COVER
13	CE013	AUTOMATIC SIZER RING
14	CE014	SIZER SUPPORT
15	CE015	ALLEN FIXING BOLT
16	CE016	LEFT BLOCK HOLDER
17	CE017	RAIL BLOCK
18	CE018	ALLEN FIXING BOLT
19	CE019	COVER
20	CE020	RIGHT BLOCK ASS'Y
21	CE021	RAIL
22	CE022	ALLEN FIXING BOLT
23	CE023	RAIL HOLDER
24	CE024	HEADNESS FIXING BOLT
25	CE025	SPRING TENSION BRACKET
26	CE026	ALLEN FIXING BOLT
27	CE027	SPRING
28	CE028	NUT
29	CE029	HANDLE BOLT
30	CE030	WASHER
31	CE031	NUT
32	CE032	CYLINDER
33	CE033	TWO TOUCH NIPPLE
34	CE034	AIR SILENCER
35	CE035	ALLEN FIXING BOLT
36		
37		

No.	Part No.	Part Name
38		
39		
40		
41		
42		
43		
44		
45		
46		
47		
48		
49		
50		
51		
52		
53		
54		
55		
56		
57		
58		
59		
60		
61		
62		
63		
64		
65		
66		
67		
68		
69		
70		
71		
72		
73		
74		

**SOLENOID VALVE & FILTER  
ASS'Y PART LIST**

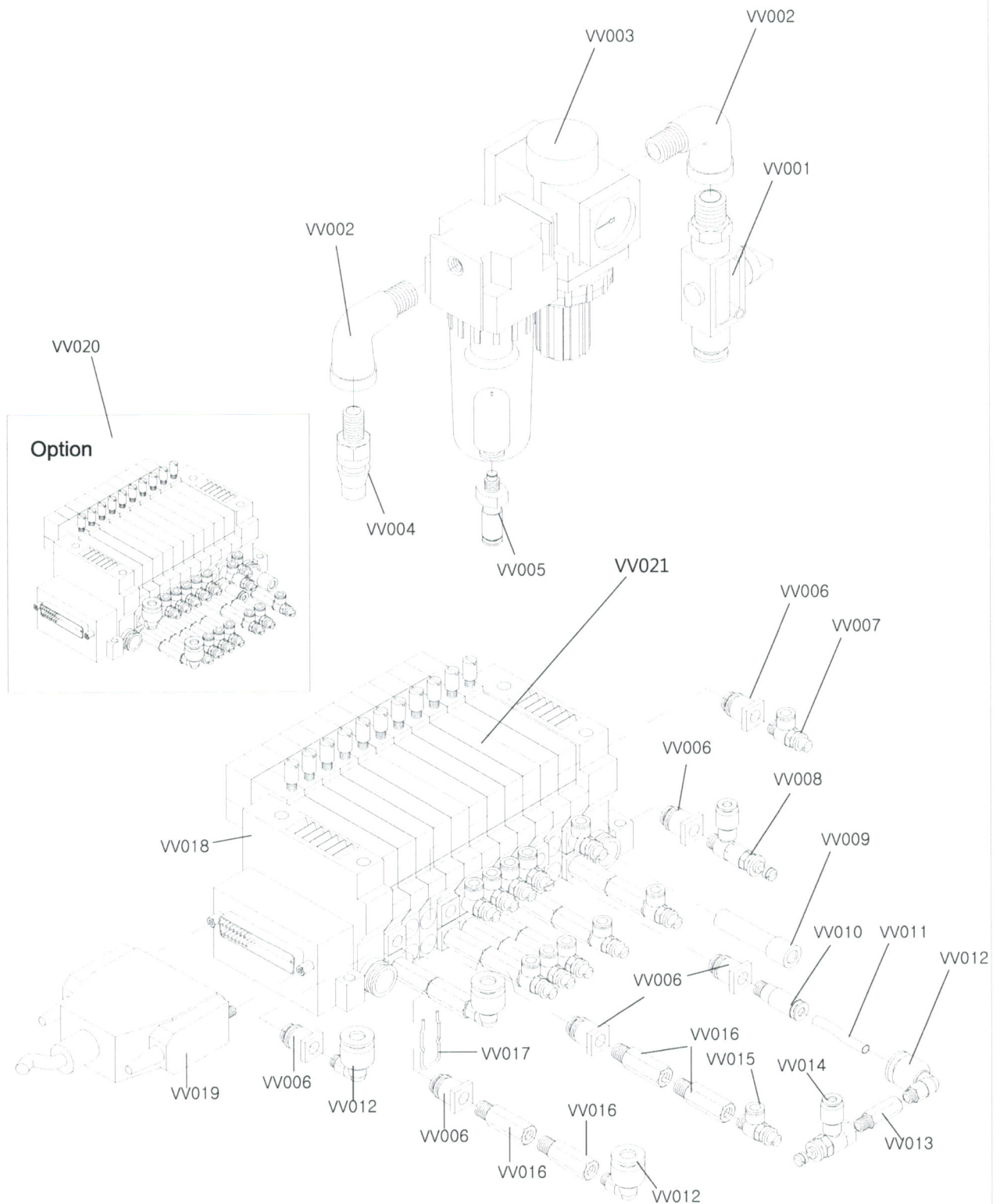

No.	Part No.	Part Name
1	VV001	HAND VALVE
2	VV002	ELBOW NIPPLE
3	VV003	FILTER & REGULATOR
4	VV004	AIR COUPLER
5	VV005	NIPPLE
6	VV006	FITTING
7	VV007	SPEED CONTROLER NIPPLE
8	VV008	REDUCING VALVE
9	VV009	BLANKING PLUG
10	VV010	NIPPLE
11	VV011	AIR HOSE
12	VV012	ELBOW NIPPLE
13	VV013	SUPPORT
14	VV014	REDUCING VALVE
15	VV015	SPEED CONTROLER NIPPLE
16	VV016	SUPPORT
17	VV017	SNAP RING
18	VV018	SOLENOID VALVE & BLOCK
19	VV019	D-SUB CABLE
20	VV020	10 VALVES ASS'Y (OPTION)
21	VV021	SOLENOID VALVE
22		
23		
24		
25		
26		
27		
28		
29		
30		
31		
32		
33		
34		
35		
36		
37		

No.	Part No.	Part Name
38		
39		
40		
41		
42		
43		
44		
45		
46		
47		
48		
49		
50		
51		
52		
53		
54		
55		
56		
57		
58		
59		
60		
61		
62		
63		
64		
65		
66		
67		
68		
69		
70		
71		
72		
73		
74		

**BOWL & ACCESSORIES  
ASS'Y PART LIST**

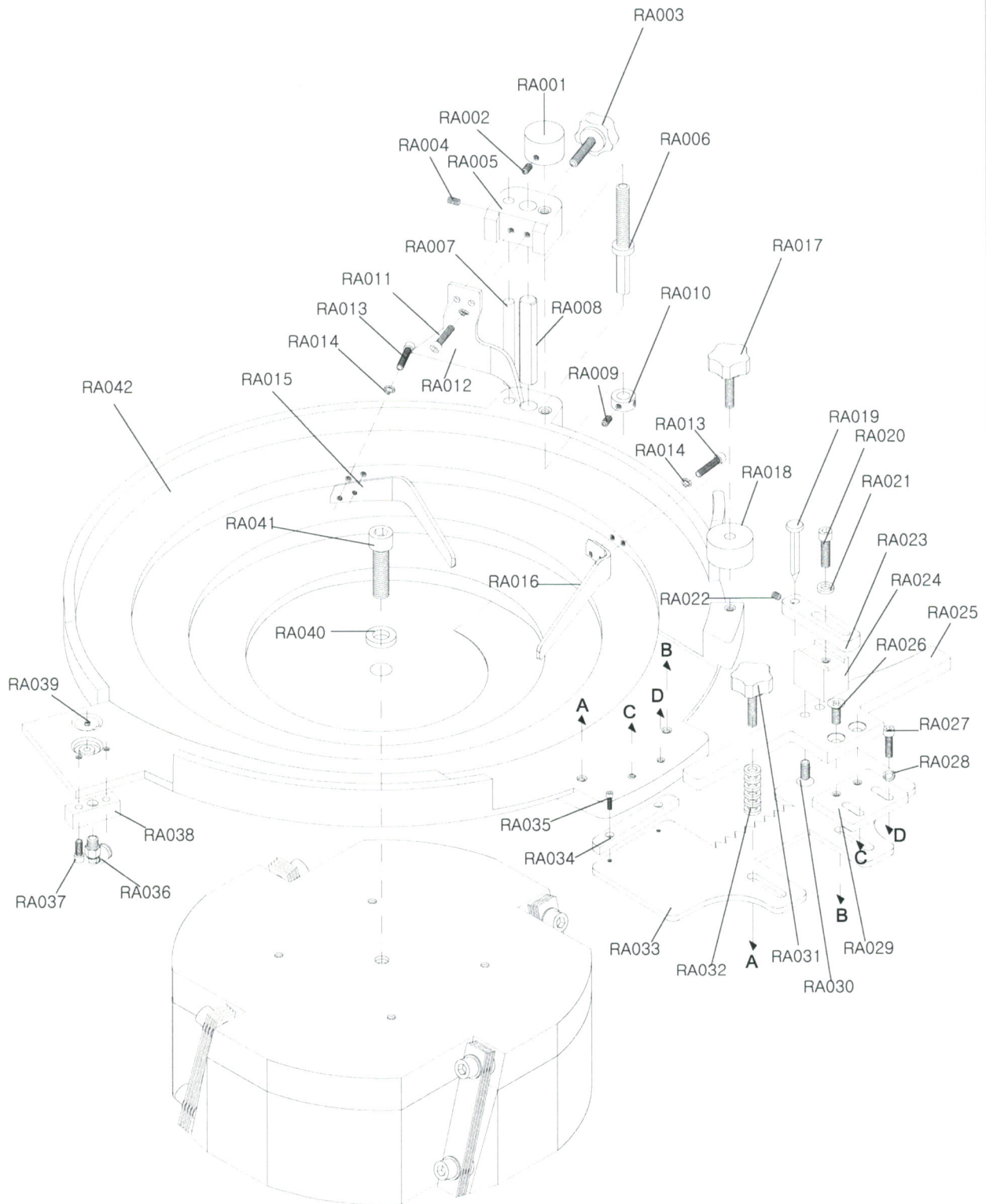

No.	Part No.	Part Name
1	RA001	HANDLE
2	RA002	HEADNESS FIXING BOLT
3	RA003	HANDLE BOLT
4	RA004	HEADNESS FIXING BOLT
5	RA005	HOLDER
6	RA006	SHAFT BOLT
7	RA007	SHAFT
8	RA008	SHAFT
9	RA009	HEADNESS FIXING BOLT
10	RA010	RING
11	RA011	ALLEN FIXING BOLT
12	RA012	BUTTON GUIDE
13	RA013	ALLEN FIXING BOLT
14	RA014	WASHER
15	RA015	BUTTON GUIDE
16	RA016	BUTTON GUIDE
17	RA017	HAND BOLT
18	RA018	BUTTON GATE
19	RA019	THICKNESS PIN
20	RA020	ALLEN FIXING BOLT
21	RA021	WASHER
22	RA022	HEADNESS FIXING BOLT
23	RA023	PIN HOLDER
24	RA024	THICKNESS HOLDER
25	RA025	BUTTON SELECTOR
26	RA026	FLAT FIXING BOLT
27	RA027	ALLEN FIXING BOLT
28	RA028	WASHER
29	RA029	BUTTON SELECTOR SUPPORT
30	RA030	FLAT FIXING BOLT
31	RA031	HANDLE BOLT
32	RA032	SPRING
33	RA033	SAWTOOTH BUTTON SELECTOR
34	RA034	BUTTON HELP GUIDE
35	RA035	ALLEN FIXING BOLT
36	RA036	ELBOW NIPPLE
37	RA037	ALLEN FIXING BOLT

No.	Part No.	Part Name
38	RA038	AIR BLOCK
39	RA039	WIND COVER
40	RA040	WASHER
41	RA041	ALLEN FIXING BOLT
42	RA042	BOWL
43		
44		
45		
46		
47		
48		
49		
50		
51		
52		
53		
54		
55		
56		
57		
58		
59		
60		
61		
62		
63		
64		
65		
66		
67		
68		
69		
70		
71		
72		
73		
74		

VIBRATER ASS'Y PART LIST

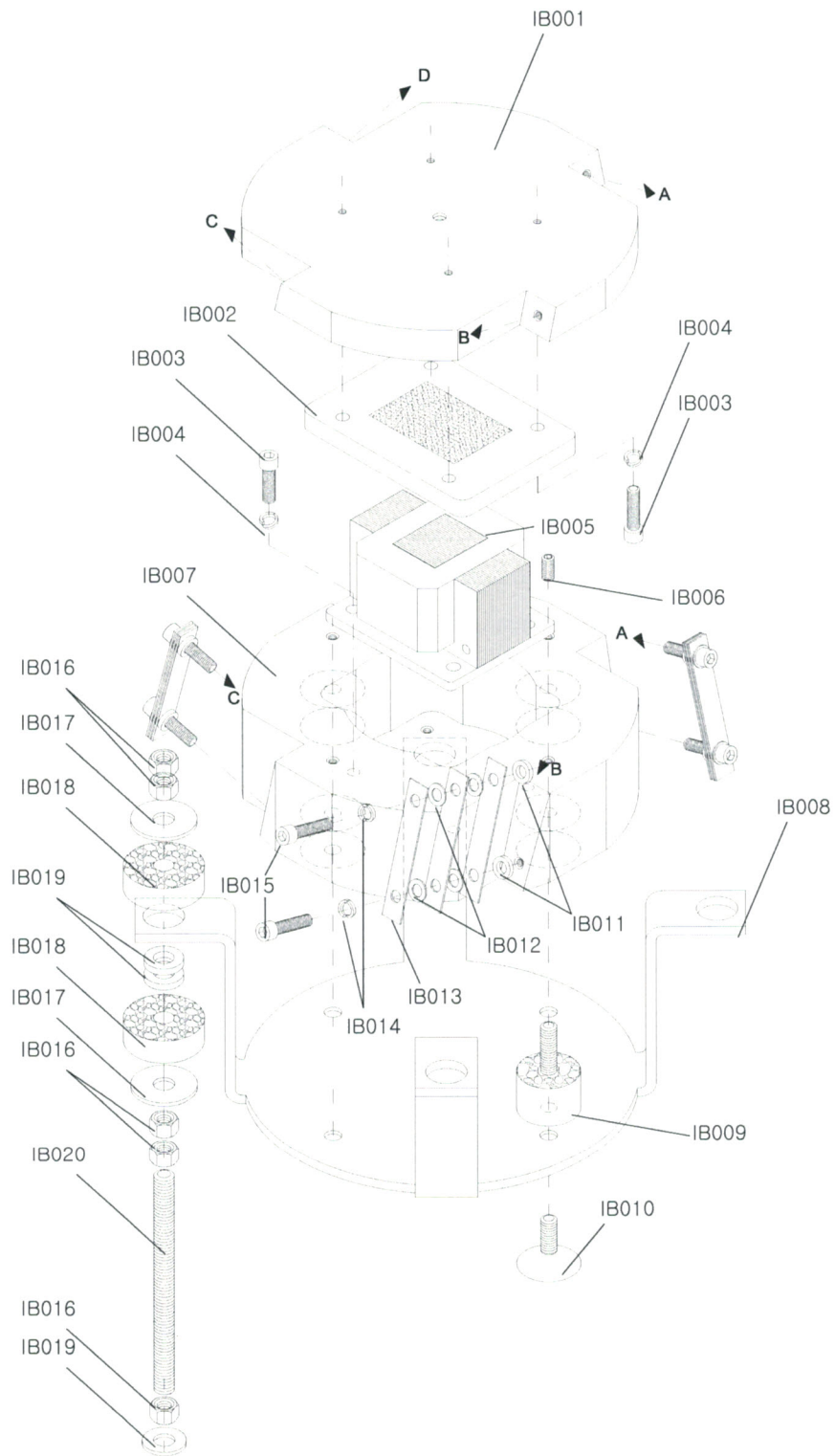

No.	Part No.	Part Name
1	IB001	VIBRATING WING
2	IB002	VIBRATOR COIL PLATE
3	IB003	ALLEN FIXING BOLT
4	IB004	SPRING WASHER
5	IB005	VIBRATOR COIL
6	IB006	HEADNESS FIXING BOLT
7	IB007	VIBRATOR HOME
8	IB008	VIBRATOR HOLDER
9	IB009	RUBBER CUSHION BOLT
10	IB010	FLAT FIXING BOLT
11	IB011	WASHER
12	IB012	WASHER
13	IB013	PLATE SPRING
14	IB014	SPRING WASHER
15	IB015	ALLEN FIXING BOLT
16	IB016	NUT
17	IB017	WASHER
18	IB018	SPONGE CUSHION
19	IB019	RUBBER WASHER
20	IB020	SHAFT BOLT
21		
22		
23		
24		
25		
26		
27		
28		
29		
30		
31		
32		
33		
34		
35		
36		
37		

No.	Part No.	Part Name
38		
39		
40		
41		
42		
43		
44		
45		
46		
47		
48		
49		
50		
51		
52		
53		
54		
55		
56		
57		
58		
59		
60		
61		
62		
63		
64		
65		
66		
67		
68		
69		
70		
71		
72		
73		
74		

CONTROL BOX ASS'Y PART LIST

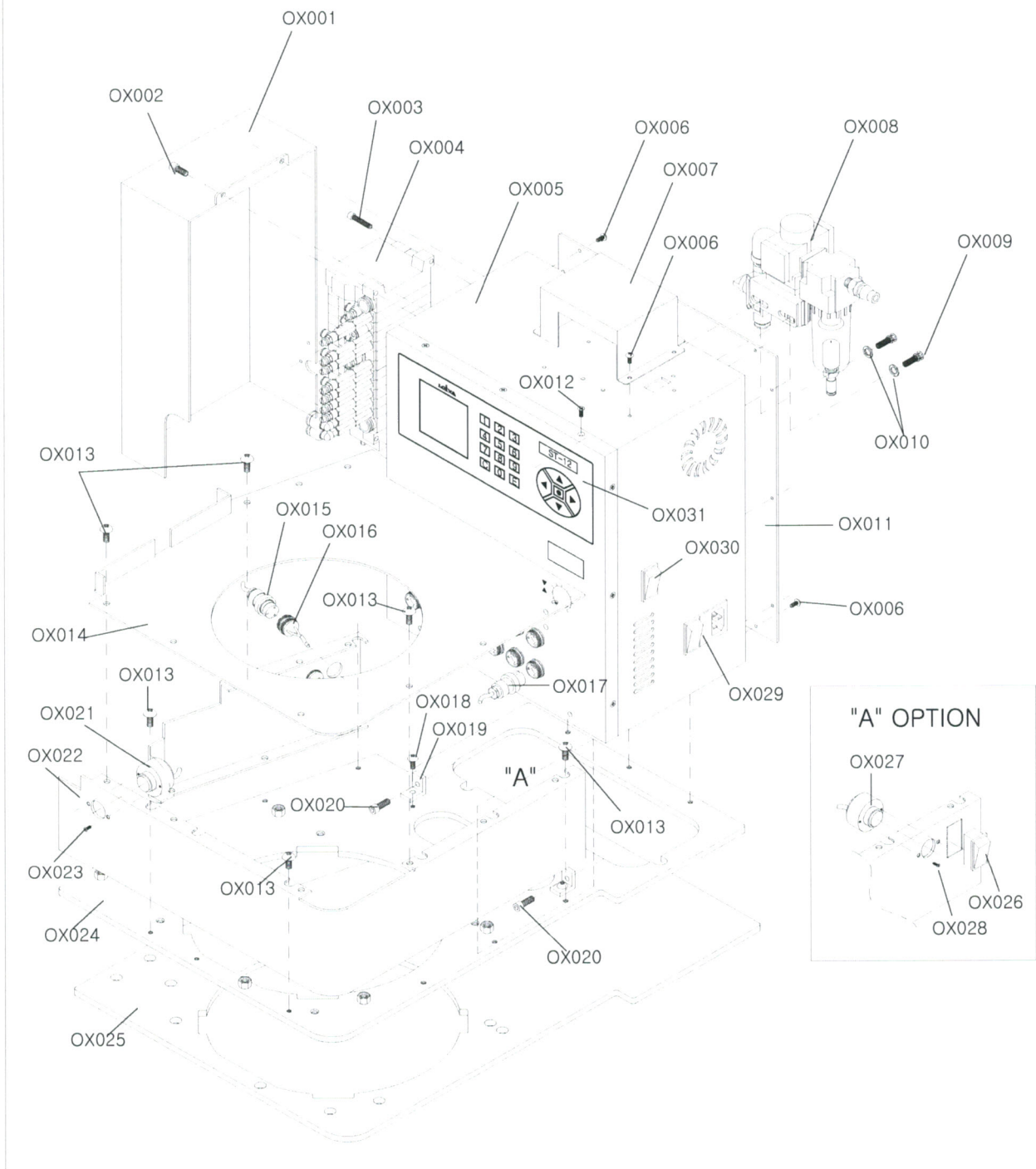

No.	Part No.	Part Name
1	OX001	SOLENOID VALVE COVER
2	OX002	ALLEN FIXING BOLT
3	OX003	ALLEN FIXING BOLT
4	OX004	SOLENOID VALVE ASS'Y
5	OX005	CONTROL BOX
6	OX006	TRUS FIXING BOLT
7	OX007	ENCORDER COVER
8	OX008	FILTER & REGULATOR ASS'Y
9	OX009	ALLEN FIXING BOLT
10	OX010	WASHER
11	OX011	CONTROL BOX BACK COVER
12	OX012	FLAT FIXING BOLT
13	OX013	TRUS FIXING BOLT
14	OX014	VIBRATOR COVER
15	OX015	RING CONNECTOR MALE
16	OX016	RING CONNECTOR FEMALE
17	OX017	RING CONNECTOR CABLE
18	OX018	TRUS FIXING BOLT
19	OX019	HOLDER
20	OX020	ALLEN FIXING BOLT
21	OX021	SWITCH
22	OX022	VIBRATOR SIDE COVER
23	OX023	FLAT FIXING BOLT
24	OX024	BASE PLATE
25	OX025	BASE RUBBER PLATE
26	OX026	COLOR SENSOR POWER SWITCH
27	OX027	COLOR CONTROL SWITCH
28	OX028	FLAT FIXING BOLT
29	OX029	CONTROL BOX MAIN SWITCH
30	OX030	VIBRATOR POWER SWITCH
31	OX031	MEMBRAIN SWITCH
32		
33		
34		
35		
36		
37		

No.	Part No.	Part Name
38		
39		
40		
41		
42		
43		
44		
45		
46		
47		
48		
49		
50		
51		
52		
53		
54		
55		
56		
57		
58		
59		
60		
61		
62		
63		
64		
65		
66		
67		
68		
69		
70		
71		
72		
73		
74		

**PRESSER FOOT ASS'Y &  
WIND DEVICE PART LIST**

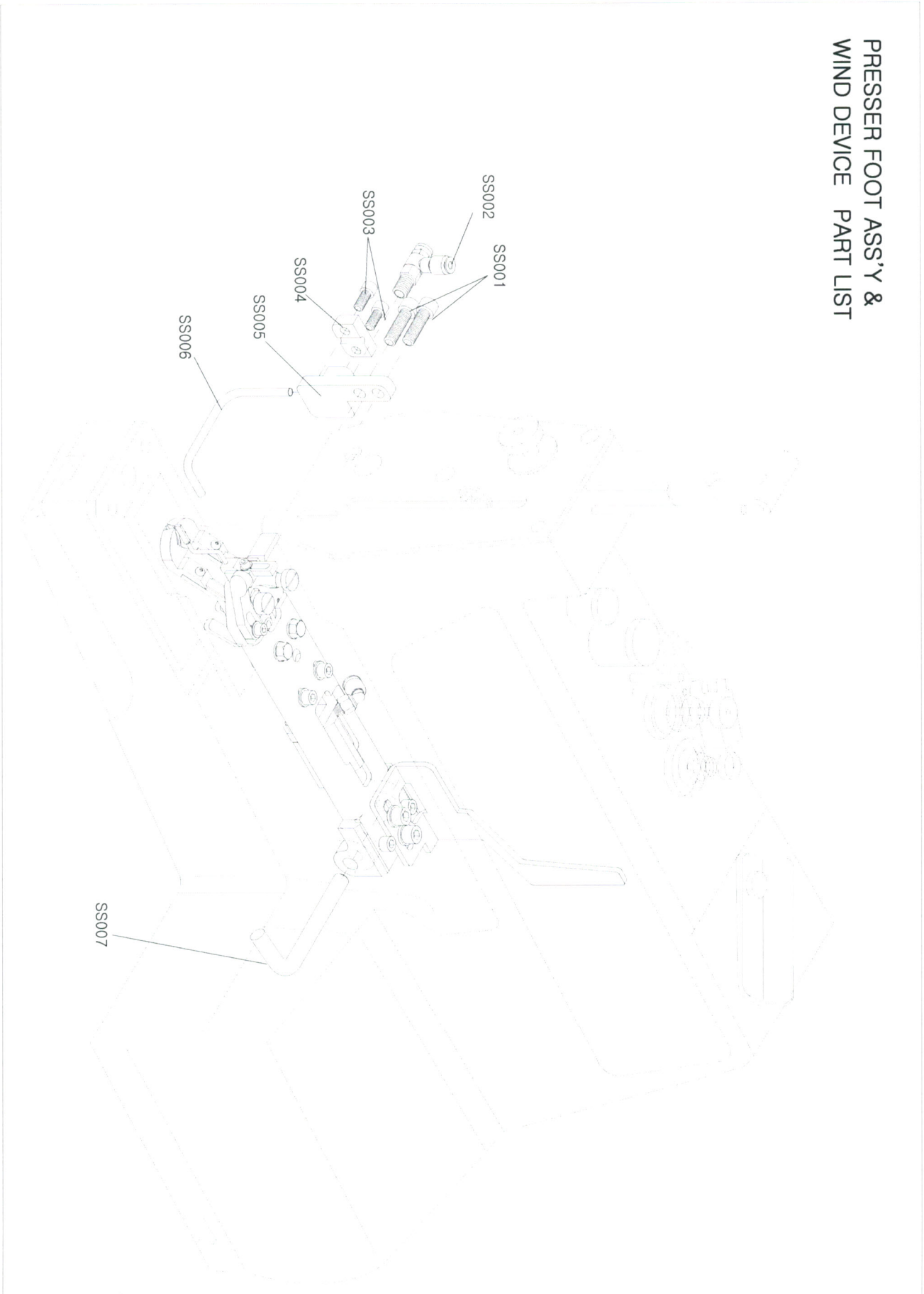

No.	Part No.	Part Name
1	SS001	ALLEN FIXING BOLT
2	SS002	SPEED CONTROLER NIPPLE
3	SS003	ALLEN FIXING BOLT
4	SS004	AIR PIPE HOLDER COVER
5	SS005	AIR PIPE HOLDER BLOCK
6	SS006	AIR PIPE
7	SS007	HOLDER KEY
8		
9		
10		
11		
12		
13		
14		
15		
16		
17		
18		
19		
20		
21		
22		
23		
24		
25		
26		
27		
28		
29		
30		
31		
32		
33		
34		
35		
36		
37		

No.	Part No.	Part Name
38		
39		
40		
41		
42		
43		
44		
45		
46		
47		
48		
49		
50		
51		
52		
53		
54		
55		
56		
57		
58		
59		
60		
61		
62		
63		
64		
65		
66		
67		
68		
69		
70		
71		
72		
73		
74		

PRESSER FOOT CLAW ASS'Y PART LIST

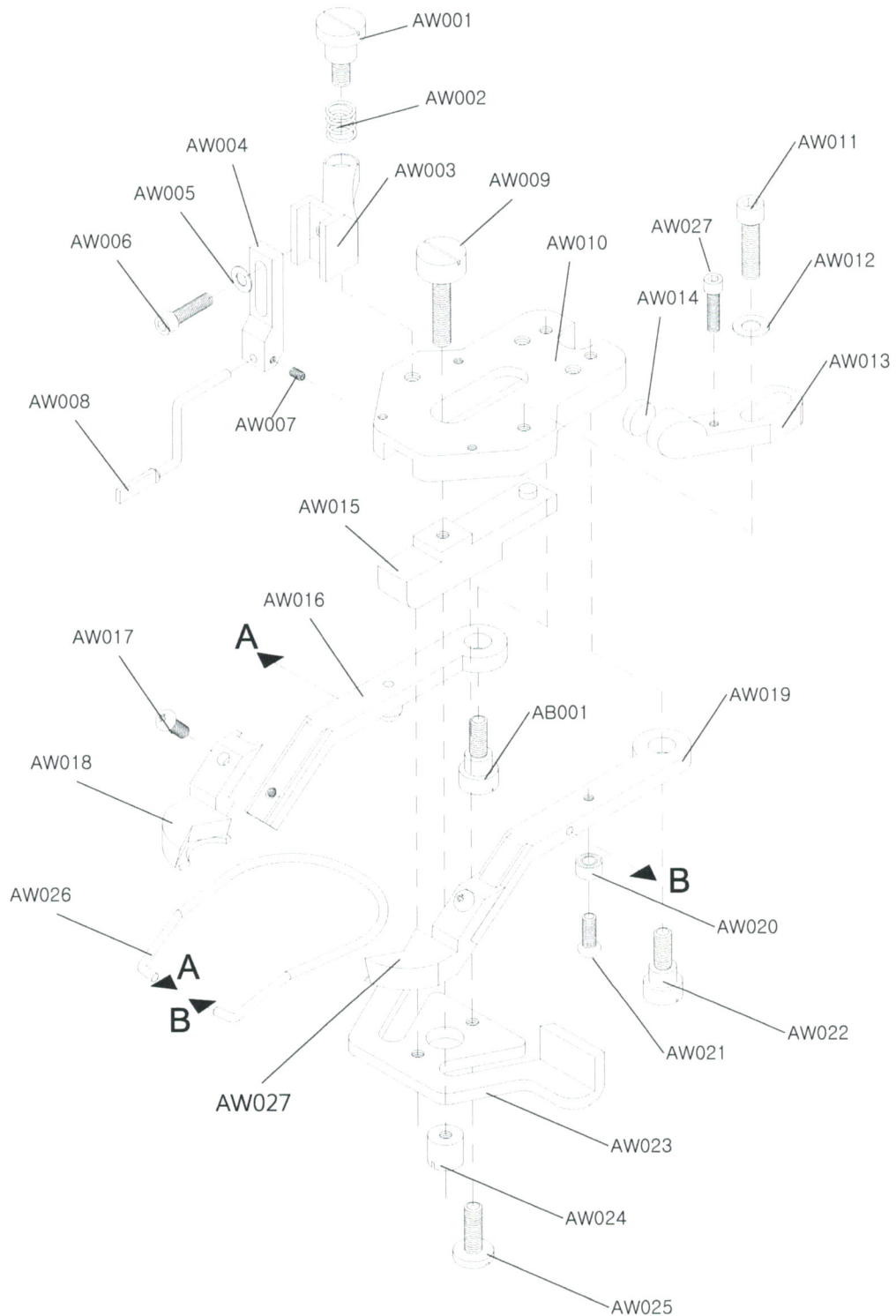

No.	Part No.	Part Name
1	AW001	FIXING BOLT
2	AW002	SPRING
3	AW003	POSTING DEVICE HOLDER
4	AW004	POSTING DEVICE
5	AW005	WASHER
6	AW006	ALLEN FIXING BOLT
7	AW007	HEADNESS FIXING BOLT
8	AW008	POSTING PIN
9	AW009	FIXING BOLT
10	AW010	CLAMP HOLDER
11	AW011	ALLEN FIXING BOLT
12	AW012	WASHER
13	AW013	MAGNETIC HOLER
14	AW014	MAGNET
15	AW015	CLAMP OPENING ASSISTANCE
16	AW016	SAWTOOTH ARM RIGHT SIDE
17	AW017	TRUS FIXING BOLT
18	AW018	SAWTOOTH RIGHT SIDE
19	AW019	SAWTOOTH ARM LEFT SIDE
20	AW020	BEARING
21	AW021	BOLT
22	AW022	FIXING BOLT
23	AW023	CLAMP OPENER
24	AW024	NUT
25	AW025	BOLT
26	AW026	SPRING
27	AW027	SAWTOOTH LEFT SIDE
28		
29		
30		
31		
32		
33		
34		
35		
36		
37		

No.	Part No.	Part Name
38		
39		
40		
41		
42		
43		
44		
45		
46		
47		
48		
49		
50		
51		
52		
53		
54		
55		
56		
57		
58		
59		
60		
61		
62		
63		
64		
65		
66		
67		
68		
69		
70		
71		
72		
73		
74		

PRESSER FOOT AIR PART FOR JUKI  
ASS'Y PART LIST

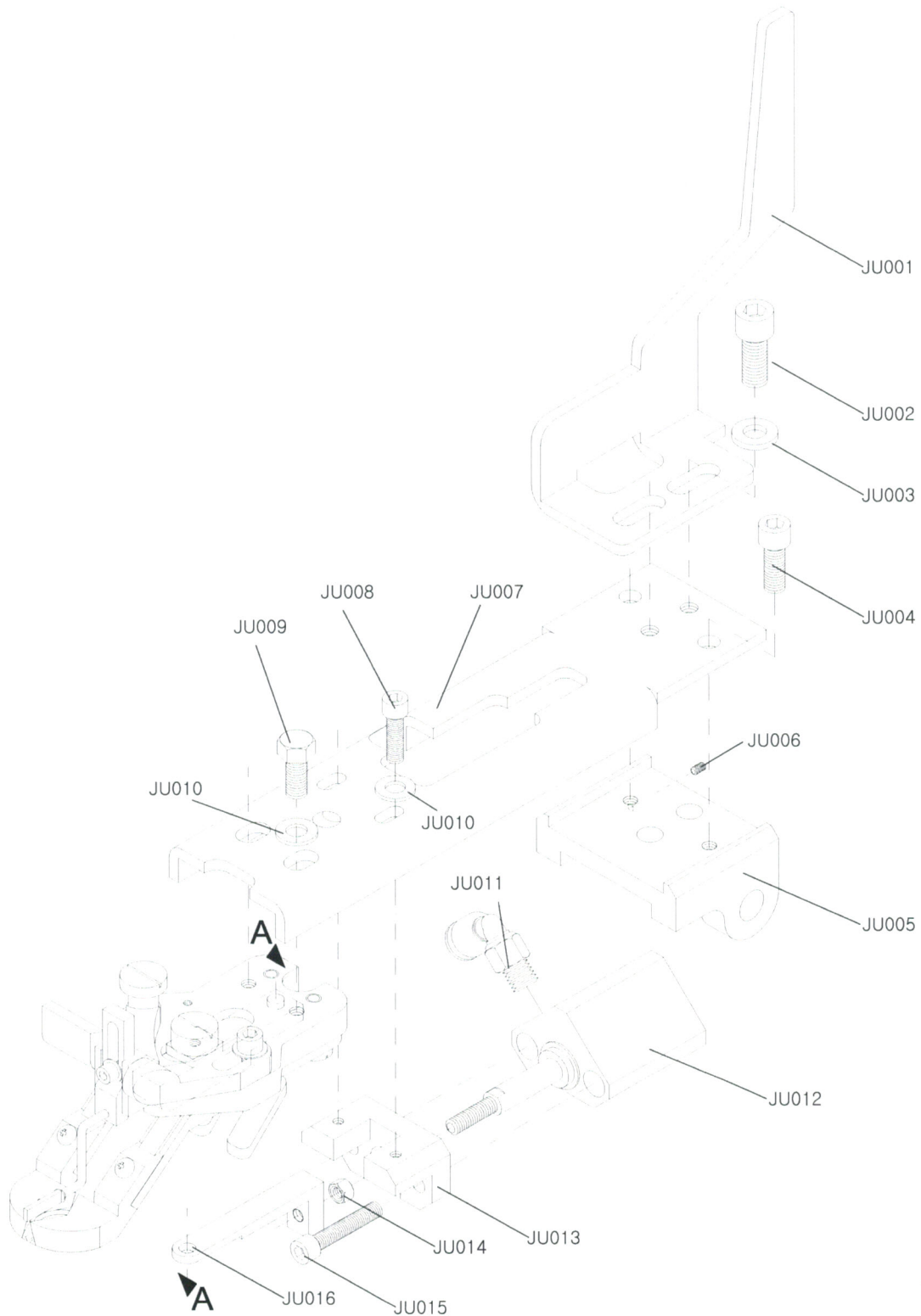

No.	Part No.	Part Name
1	JU001	HANDLE FOR PRESSOR FOOT
2	JU002	ALLEN FIXING BOLT
3	JU003	WASHER
4	JU004	ALLEN FIXING BOLT
5	JU005	CLAMP STAND
6	JU006	HEADNESS FIXING BOLT
7	JU007	CLAMP ASSEMBLY
8	JU008	ALLEN FIXING BOLT
9	JU009	FIXING BOLT
10	JU010	WASHER
11	JU011	ELBOW NIPPLE
12	JU012	CYLINDER
13	JU013	CYLINDER HOLDER
14	JU014	NUT
15	JU015	ALLEN FIXING BOLT
16	JU016	CLAMP OPENIG ASSISTANCE
17		
18		
19		
20		
21		
22		
23		
24		
25		
26		
27		
28		
29		
30		
31		
32		
33		
34		
35		
36		
37		

No.	Part No.	Part Name
38		
39		
40		
41		
42		
43		
44		
45		
46		
47		
48		
49		
50		
51		
52		
53		
54		
55		
56		
57		
58		
59		
60		
61		
62		
63		
64		
65		
66		
67		
68		
69		
70		
71		
72		
73		
74		

PRESSER FOOT AIR PART FOR UNICON  
ASS'Y PART LIST

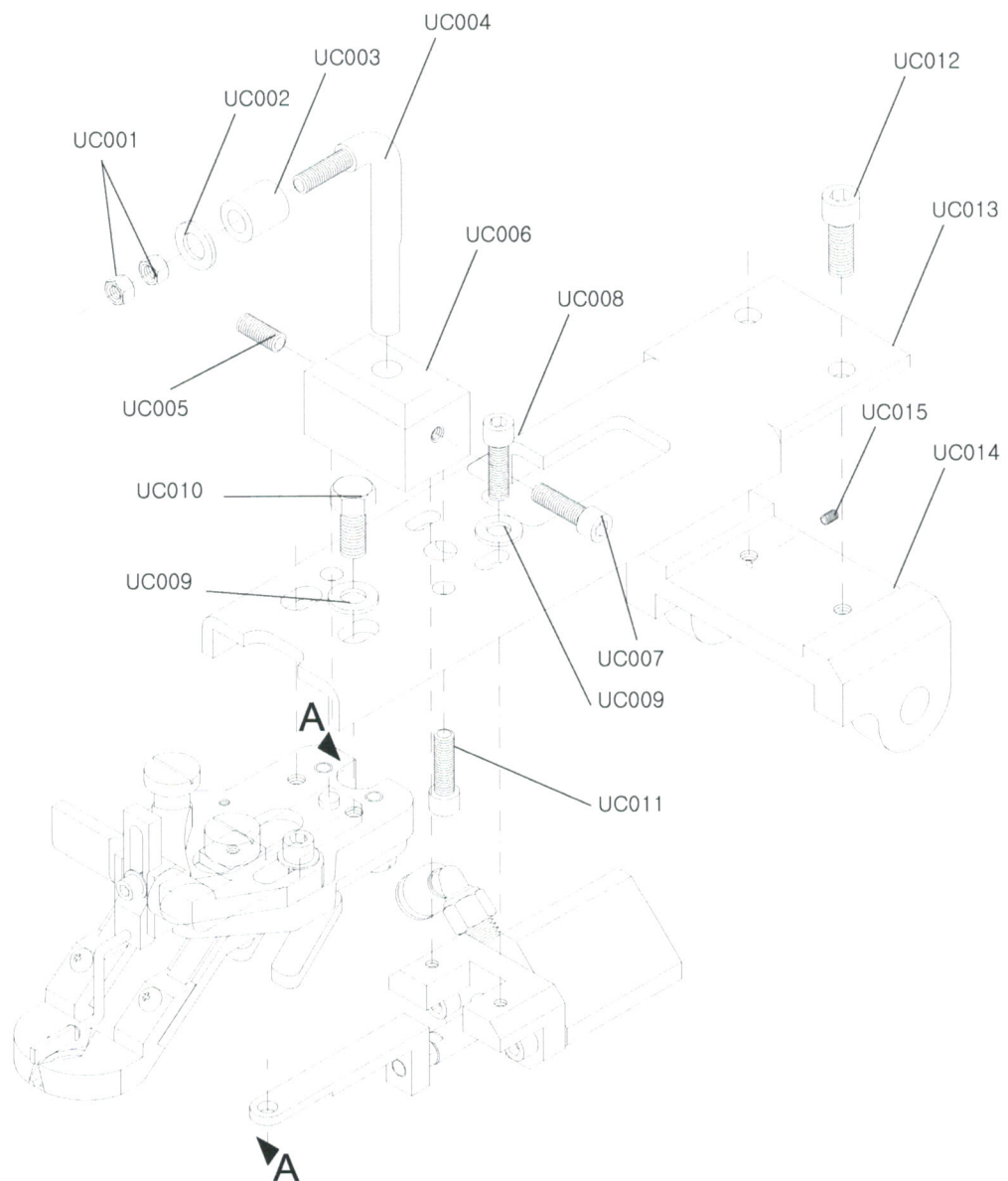

No.	Part No.	Part Name
1	UC001	NUT
2	UC002	WASHER
3	UC003	BUSHING
4	UC004	HANDLE
5	UC005	HEADNESS FIXING BOLT
6	UC006	HANDLE HOLDER
7	UC007	HANDLE HOLDER
8	UC008	HANDLE HOLDER
9	UC009	WASHER
10	UC010	FIXING BOLT
11	UC011	HANDLE HOLDER
12	UC012	HANDLE HOLDER
13	UC013	PRESSOR FOOT BODY
14	UC014	PRESSOR FOOT HOLDER
15	UC015	HEADNESS FIXING BOLT
16		
17		
18		
19		
20		
21		
22		
23		
24		
25		
26		
27		
28		
29		
30		
31		
32		
33		
34		
35		
36		
37		

No.	Part No.	Part Name
38		
39		
40		
41		
42		
43		
44		
45		
46		
47		
48		
49		
50		
51		
52		
53		
54		
55		
56		
57		
58		
59		
60		
61		
62		
63		
64		
65		
66		
67		
68		
69		
70		
71		
72		
73		
74		

CONTROL BOX ASS'Y PART LIST

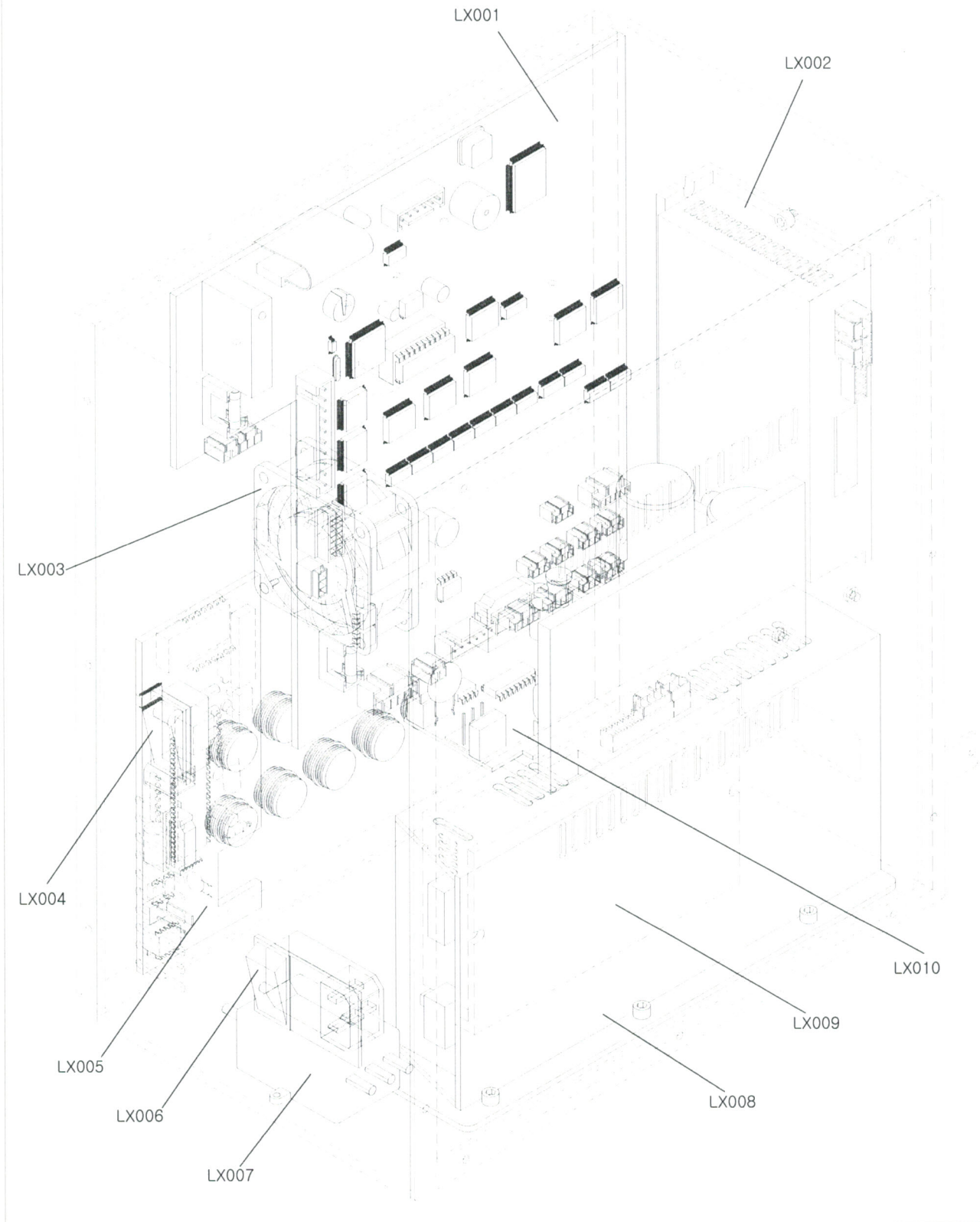

No.	Part No.	Part Name
1	LX001	MAIN PCB BOARD
2	LX002	DRIVER
3	LX003	FAN
4	LX004	VIBRATOR POWER SWITCH
5	LX005	VIBRATOR CONTROL PCB BOARD
6	LX006	CONTROL BOX MAIN SWITCH
7	LX007	NOISE FILTER
8	LX008	SMPS
9	LX009	DRIVER
10	LX010	VIBRATOR POWER PCB BOARD
11		
12		
13		
14		
15		
16		
17		
18		
19		
20		
21		
22		
23		
24		
25		
26		
27		
28		
29		
30		
31		
32		
33		
34		
35		
36		
37		

No.	Part No.	Part Name
38		
39		
40		
41		
42		
43		
44		
45		
46		
47		
48		
49		
50		
51		
52		
53		
54		
55		
56		
57		
58		
59		
60		
61		
62		
63		
64		
65		
66		
67		
68		
69		
70		
71		
72		
73		
74		

ADD COLOR SENSOR ASS'Y PART LIST

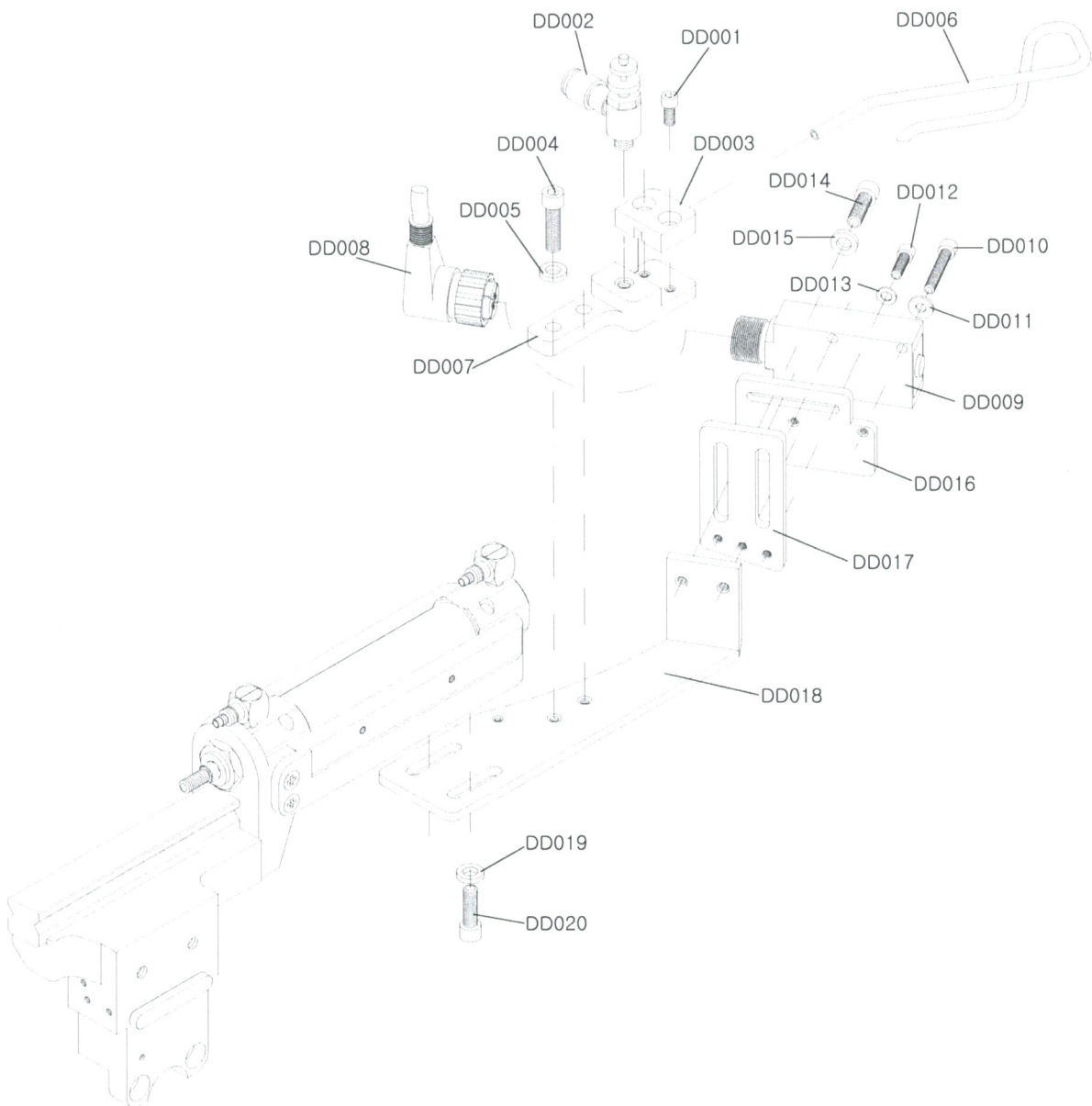

No.	Part No.	Part Name
1	DD001	ALLEN FIXING BOLT
2	DD002	SPEED CONTROLER NIPPLE
3	DD003	AIR PIPE HOLDER COVER
4	DD004	ALLEN FIXING BOLT
5	DD005	WASHER
6	DD006	AIR PIPE
7	DD007	AIR PIPE HOLDER BLOCK
8	DD008	SENSOR CABLE
9	DD009	COLOR SENSOR
10	DD010	ALLEN FIXING BOLT
11	DD011	WASHER
12	DD012	ALLEN FIXING BOLT
13	DD013	WASHER
14	DD014	ALLEN FIXING BOLT
15	DD015	WASHER
16	DD016	SENSOR BRACKET
17	DD017	SENSOR BRACKET HOLDER
18	DD018	SENSOR ASS'Y HOLDER
19	DD019	WASHER
20	DD020	ALLEN FIXING BOLT
21		
22		
23		
24		
25		
26		
27		
28		
29		
30		
31		
32		
33		
34		
35		
36		

No.	Part No.	Part Name
38		
39		
40		
41		
42		
43		
44		
45		
46		
47		
48		
49		
50		
51		
52		
53		
54		
55		
56		
57		
58		
59		
60		
61		
62		
63		
64		
65		
66		
67		
68		
69		
70		
71		
72		
73		

**EC DECLARATION OF CONFORMITY**

In accordance with:-

**EC Machinery Directive 2006/42/EC (Annex II 1 A)**

We herewith declare that the:-

**Product description:** DIGITALLY CONTROLLED FULLY PROGRAMMABLE  
BUTTON FEEDER ATTACHMENT

**Model Number:** ST-12

**Serial Number:** N/A

**Manufacturer:** LOIVA

**Address:** 3FL, 768-12 OHJUNG DONG, OHJUNG GU, BUCHEON CITY,  
KYOONGGI DO, KOREA

when used in accordance with the manufacture's instructions, conforms with the essential health and safety requirements of the Machinery Directive by virtue of its design, construction and assessment.

In support of this declaration the subject machine has been evaluated as complying with the following:-

- a) The Machinery Directive (Annex I), by compliance with the applicable clauses of the following harmonized standards:-

**ISO 12100:2010 and EN 60204-1:2006**

- b) Technical file No: MD-12094TH

If the equipment is modified without the agreement of the undersigned, this declaration becomes invalid.

**LOIVA**

KIM HYOUNG GI

.....  
Representative of **LOIVA**

CEO

.....  
Position in Organization

Signature signed on 15/10/2012



*Thinks First of the Operator Being!*

**MANUFACTURER & SELLER**

**LOIVA**

*Automated machinery & Various special attachments*

*768-12, OhJung Dong, Ohjung Gu, Bucheon City, Korea*

*Tel. +82 32 677 3321 / 3322 / Fax. +82 32 677 3323*

*<http://www.loivaintech.com> e-mail: [loiva@naver.com](mailto:loiva@naver.com)*